



2023

ÜRÜN KATALOĞU

PRODUCT CATALOGUE

Siz üretirken biz destek oluyoruz
We support while you produce

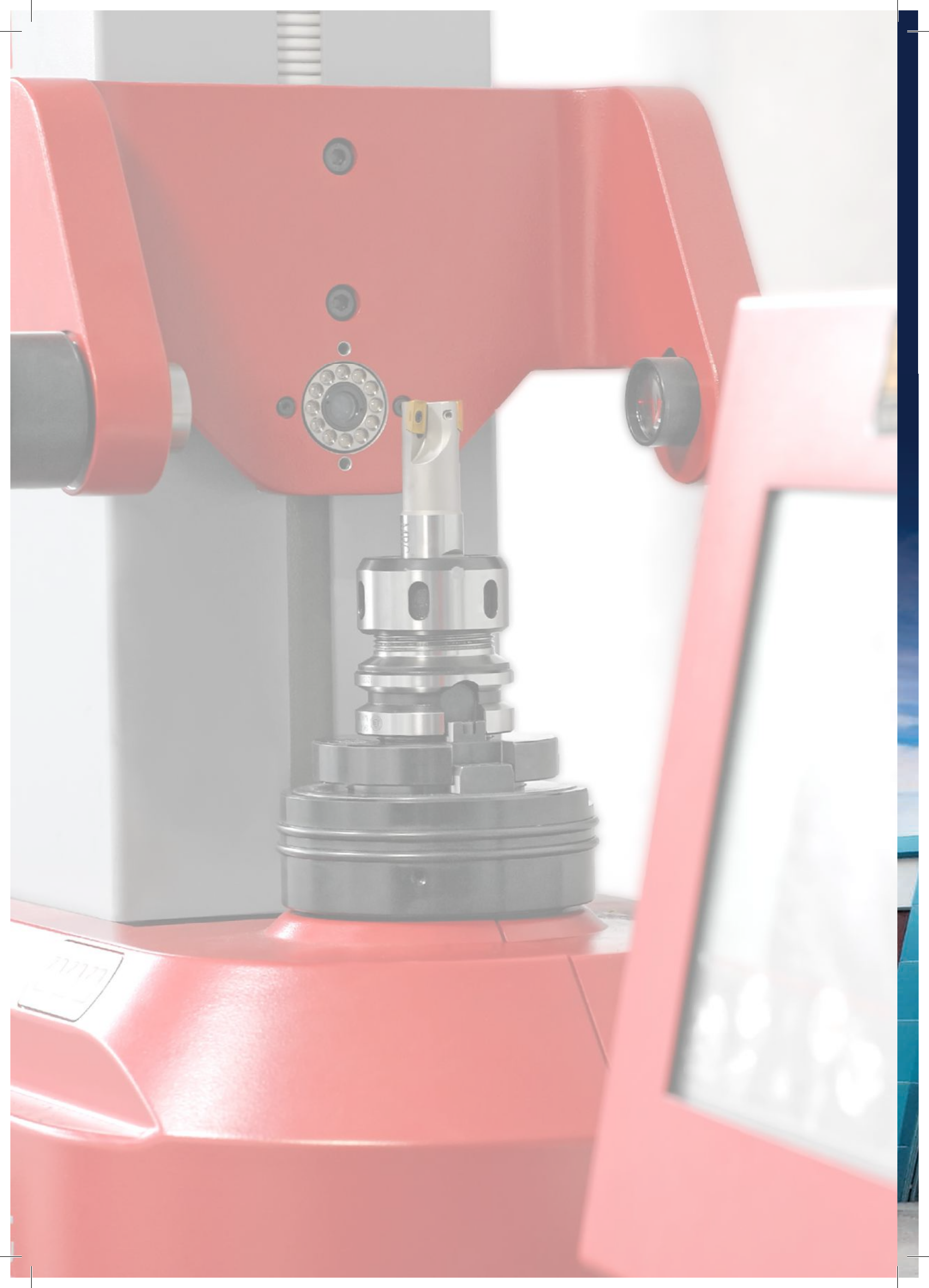



“Siz üretirken biz destek oluyoruz”
“We support while you produce”





Misyonumuz

Sürdürülebilir kalkınmayı kendimize yol haritası kabul ederek; çevreye duyarlı, en az maliyetle, paydaşlarımızın isteklerini karşılayan bir şirket olmaktır.

Our Mission

To be a company which recognise sustainable development as a road map to us to meet the demands of our clients with environmentally sensitive with minimal cost.

Vizyonumuz

Toplam kalite felsefesi ile Dünya Sanayisi'ne güvenilir, kaliteli ürün ve hizmet vermektir.

Müşteri istek ve ihtiyaçlarını tam olarak anlamak ve karşılamak, kalite yönetim sistemimizin gelişimini ve etkinliğini sağlayarak iç ve dış pazarda rekabet gücümüzü arttırmak, sürekli gelişmek için tüm çalışanların eğitimini ve katılımını sağlamak, ürün kalitemizi arttırmak ve maliyetlerimizi düşürmek.

Sektörümüzdeki teknolojik gelişmeleri yakından takip etmek ve bu gelişmeleri her alanda uygulamak.

Our Vision











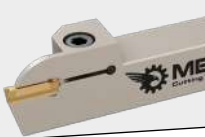

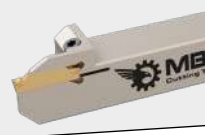









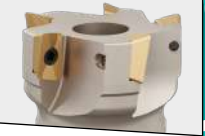
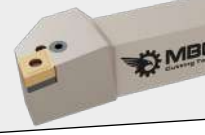

With the philosophy of total quality; serve the World Industrial Estate reliable and high quality products.

Understand exactly what the clients requests and needs, provide the development and effectiveness of our quality management system to increase our competitiveness in domestic and international market; to continuous development ensure the training and participation of all employees; improve the products quality and reduce the costs.

Follow the technological developments in our industry and implement these developments in all areas.

İÇİNDEKİLER

INDEX

sayfa/page	12-19		DIŞ KANAL KATERLERİ EXTERNAL GROOVING TOOLHOLDERS	ŞAFTLI TARAMALAR MILLING TOOLS		sayfa/page	67-110
sayfa/page	20-21		DIŞ KANAL KATERLERİ OTOMAT EXTERNAL GROOVING TOOLHOLDERS AUTOMAT	ŞAFTLI TARAMALAR HIGH FEED MILLING TOOLS HIGH FEED		sayfa/page	111-128
sayfa/page	22-27		İÇ KANAL KATERLERİ INTERNAL GROOVING TOOLHOLDERS	B.ST HD 12 B.ST HD 12		sayfa/page	129
sayfa/page	28-37		S-SİSTEM DIŞ ÇAP TORNALAMA KATERLERİ S-SYSTEM EXTERNAL TURNING TOOLHOLDERS	VİDALI TAKIM TUTUCULARI SCREW TOOL HOLDERS		sayfa/page	130
sayfa/page	38-39		C-SİSTEM DIŞ ÇAP TORNALAMA KATERLERİ C-SYSTEM EXTERNAL TURNING TOOLHOLDERS	HIGH FEED FINISH TAKIMLARI HIGH FEED FINISH TOOLS		sayfa/page	131-133
sayfa/page	40-47		T-SİSTEM DIŞ ÇAP TORNALAMA KATERLERİ T-SYSTEM EXTERNAL TURNING TOOLHOLDERS	FREZELEME TAKIMLARI FACE MILLING		sayfa/page	134-138
sayfa/page	48-49		M-SİSTEM DIŞ ÇAP TORNALAMA KATERLERİ M-SYSTEM EXTERNAL TURNING TOOLHOLDERS	TARAMA KAFALARI FACE MILLING		sayfa/page	139-195
sayfa/page	50-51		P-SİSTEM DIŞ ÇAP TORNALAMA KATERLERİ P-SYSTEM EXTERNAL TURNING TOOLHOLDERS	HIGH FEED TARAMA KAFALARI HIGH FEED MILLINGS		sayfa/page	196-211
sayfa/page	52-57		S-SİSTEM İÇ ÇAP TORNALAMA KATERLERİ S-SYSTEM INTERNAL TURNING TOOLHOLDERS	VİDALI TARAMALAR SCREW TYPE		sayfa/page	212-235
sayfa/page	57-58		C-SİSTEM İÇ ÇAP TORNALAMA KATERLERİ C-SYSTEM INTERNAL TURNING TOOLHOLDERS	U-DRILLER U-DRILLS		sayfa/page	236-248
sayfa/page	60-62		T-SİSTEM İÇ ÇAP TORNALAMA KATERLERİ T-SYSTEM INTERNAL TURNING TOOLHOLDERS	KATERLER CUTTING TOOLS		sayfa/page	249-251
sayfa/page	64		M-SİSTEM İÇ ÇAP TORNALAMA KATERLERİ M-SYSTEM INTERNAL TURNING TOOLHOLDERS	YUMUŞAK AYAKLAR SOFT JAWS		sayfa/page	252
sayfa/page	65-66		P-SİSTEM İÇ ÇAP TORNALAMA KATERLERİ P-SYSTEM INTERNAL TURNING TOOLHOLDERS	YEDEK PARÇALAR SPARE PARTS		sayfa/page	253-255

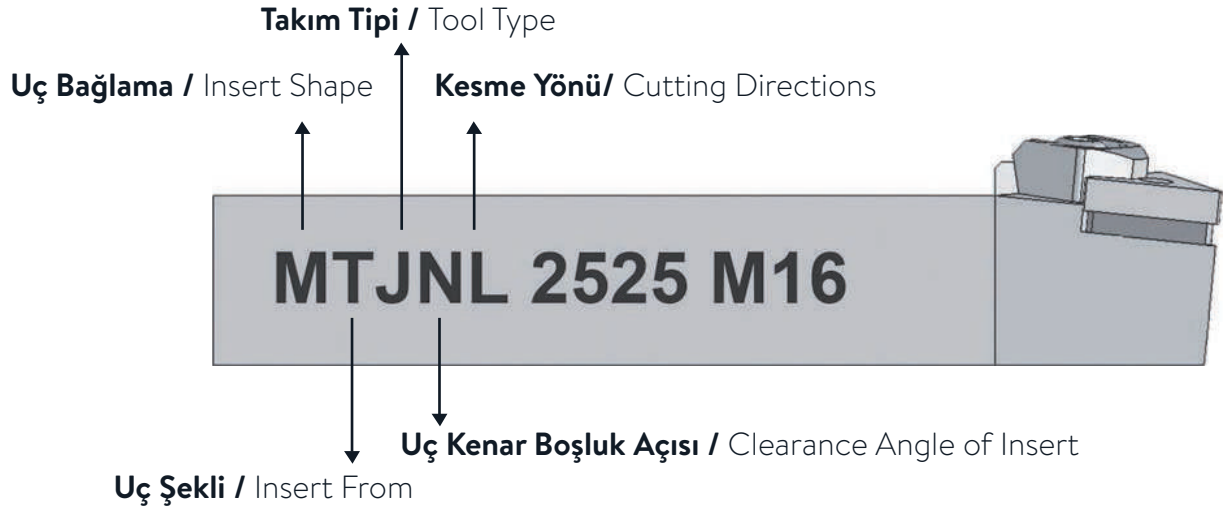

Takım Tipi / Tool Type ————— **Kesme Yönü / Cutting Directions**

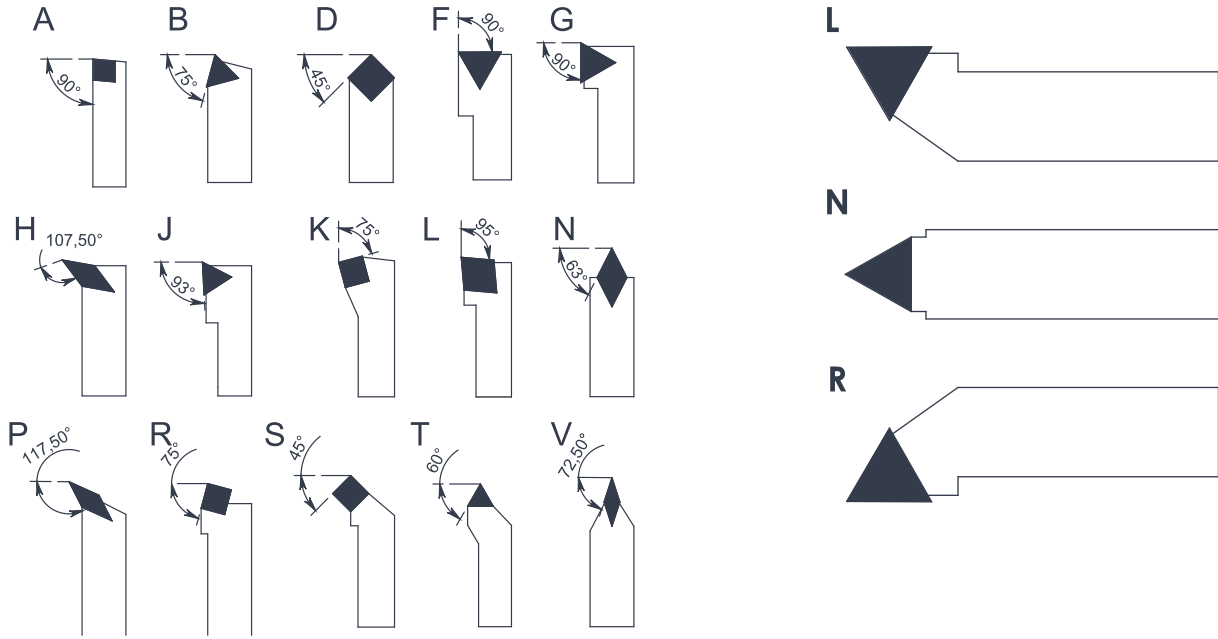

————— **Uç Şekli / Insert From** ————— **Uç Kenar Boşluk Açısı / Clearance Angle of Insert**

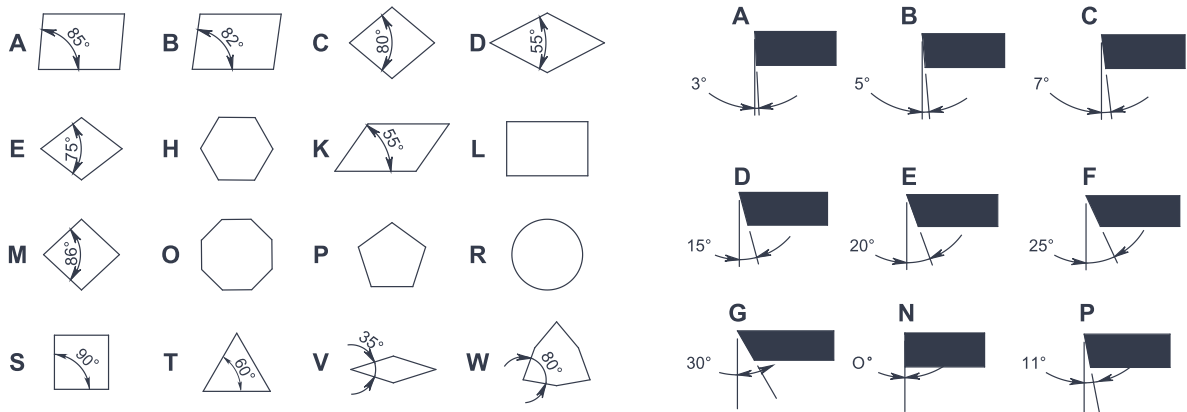

M Sistem
M System

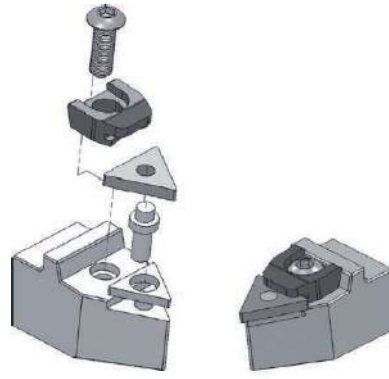

S Sistem
S System

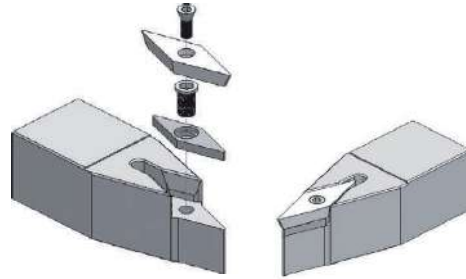

T Sistem
T System

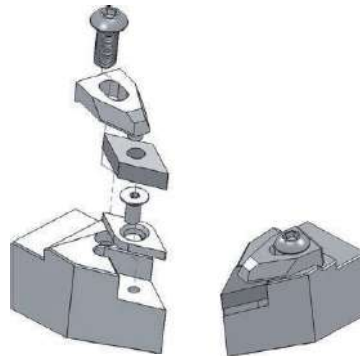



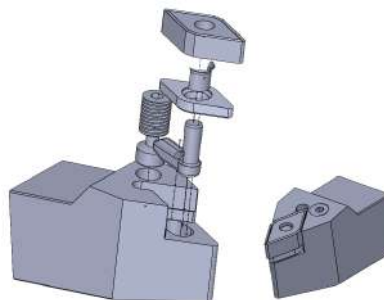





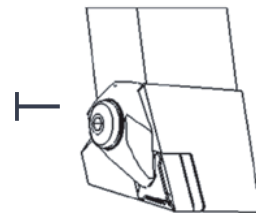



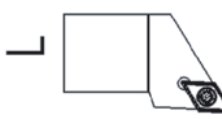



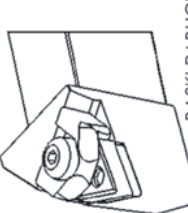



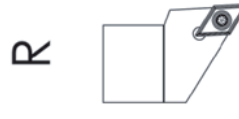



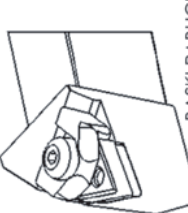



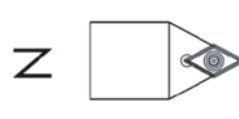



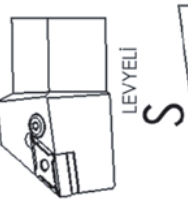
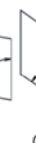























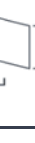





































































P Sistem
P System



DIŞ ÇAP KATERLERİ İÇİN ISO KODLARI

EXTERNAL TURNING TOOLS ISO CODES

1	2	3	4	5	6	7	8	9
1 T	2 D	3 J	4 N	5 R	6 20	7 20	8 K	9 15
Uç Bağlama Sistemi Clamping System Klemmsystem	Kesici Uç Tipi Insert form WSP - Form	Kater Tipi Style Werkzeugtyp	Uç Açısı Clearance angle WSP-Freiwinkel	Kater Yönü Holder execution Bearbeitungsrichtung	Şaft Yüksekliği Height of shank Schafthöhe	Şaft Genişliği Width of shank Schafthbreite	Takım Boyu Length of holder Werkzeuglänge	Uç Kenar Uzunluğu Length of cutting ed WSP-Größe
 T	 A	 A	 A	 L	 A	 A	 A	 A
 M ÇEKTİRMELİ	 B	 B	 B	 R	 B	 B	 B	 B
 P BAŞKI PABUÇLU	 C	 C	 C	 N	 C	 C	 C	 C
 S LEVYELİ	 D	 D	 D	 N	 D	 D	 D	 D
 V VIDALI	 E	 E	 E	 N ÖZEL SPECIAL Sonderform	 E	 E	 E	 E
	 H	 H	 H	 N	 H	 H	 H	 H
	 K	 K	 K	 N	 K	 K	 K	 K
	 L	 L	 L	 N	 L	 L	 L	 L
	 M	 M	 M	 N	 M	 M	 M	 M
	 O	 O	 O	 N	 O	 O	 O	 O
	 P	 P	 P	 N	 P	 P	 P	 P
	 R	 R	 R	 N	 R	 R	 R	 R
	 S	 S	 S	 N	 S	 S	 S	 S
	 T	 T	 T	 N	 T	 T	 T	 T
	 V	 V	 V	 N	 V	 V	 V	 V
	 W	 W	 W	 N	 W	 W	 W	 W

TORNALAMA UÇLARI İÇİN ISO KODLARI

TURNING INSERT ISO CODES

7

Uç Radüsü
Chamfer or Corner Radius
Planfase Oder Eckenradius

SEMBOL	R
00	0
02	0.2
04	0.4
08	0.8
12	1.2
16	1.6
24	2.4
32	3.2

6

Uç Kalınlığı
Height of Cutting Edge
Schneidkantenhöhe

SEMBOL	S
01	1.59
02	1.98
03	2.38
04	2.77
05	3.18
06	3.56
07	3.97
08	4.35
09	4.76

4

Kesici Delik Tipi
Type of Insert
Plattentyp

2

Uç Açısı
Clearance Angle
Fräswinkel

1

Kesici Uç Tipi
Shape
Plattentform

8 **9**
H **R**

7
08

6
06

5
15

4
G

3
M

2
N

1
D

5

Kesme Kenarı Şekli
Insert Forms
WSP-Form

Uç Formları
Insert Forms
WSP-Form

5

Kesme Kenar Uzunluğu
Length of Cutting Edge
Schneidenlänge

3

Uç Toleransları
Tolerance
Toleranz

SEMBOL	Shape	Plattentform	m (±)	S (±)	d (±)
A			0,005	0,025	0,025
F			0,005	0,025	0,013
C			0,013	0,025	0,025
H			0,013	0,025	0,013
E			0,025	0,025	0,025
G			0,025	0,130	0,025
J			0,005	0,025	0,05-0,013
K			0,013	0,025	0,05-0,013
L			0,025	0,025	0,05-0,013
M			0,08-0,18	0,130	0,05-0,013
N			0,08-0,18	0,025	0,05-0,013
U			0,05-0,38	0,130	0,08-0,025



DIŞ KANAL KATERLERİ

EXTERNAL GROOVING TOOLHOLDERS

DKT I

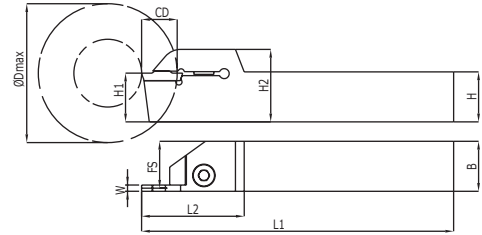

Kesici Uç Uyumluluğu Insert Suitability	Stok / Stock		Takım Ölçüleri / Dimension (mm)										Uç Insert	Vida Screw	Anahtar Allen Key	
	R	L	Dmax	W	H	B	FS	L1	L2	H1	H2	CD				
DKT I																
DKT I 001 DGN	✓	✓	62	2	12	12	11	90	31	12	24	16	DGN-2	M5X16	A4	
DKT I 002 DGN	✓	✓	62	2	16	16	15	125	43	16	28,5	16				M8X27
DKT I 003 DGN	✓	✓	62	2	20	20	19	125	43	20	28,5	18				
DKT I 004 DGN	✓	✓	62	2	25	25	24	150	47	25	35	22	DGN-3	M5X16		
DKT I 005 DGN	✓	✓	62	3	12	12	10,5	90	31	12	24	16				M8X27
DKT I 006 DGN	✓	✓	62	3	16	16	14,5	125	43	16	28,5	18				
DKT I 007 DGN	✓	✓	62	3	20	20	18,5	125	43	20	28,5	18	DGN-4	M8X27		
DKT I 008 DGN	✓	✓	62	3	25	25	23,5	150	47	25	35	22				M5X16
DKT I 009 DGN	✓	✗	62	3	32	32	30,5	170	47	32	42	22				
DKT I 010 DGN	✓	✓	62	4	16	16	14	125	43	16	28,5	18	DGN-5	M8X27		
DKT I 011 DGN	✓	✓	62	4	20	20	18	125	43	20	28,5	18				M5X16
DKT I 012 DGN	✓	✓	62	4	25	25	23	150	47	25	35	22				
DKT I 013 DGN	✓	✗	62	4	32	32	30	170	47	32	42	22	DGN-6	M8X27		
DKT I 014 DGN	✓	✓	62	5	20	20	17,5	125	43	20	28,5	18			M5X16	
DKT I 015 DGN	✓	✓	62	5	25	25	22,5	150	47	25	35	22				
DKT I 016 DGN	✓	✗	62	5	32	32	29,5	170	47	32	42	22	DGN-3	M8X27		
DKT I 017 DGN	✓	✓	62	6	25	25	22,5	150	47	25	35	22			M5X16	
DKT I 018 DGN	✓	✗	62	6	32	32	29,5	170	47	32	42	22				
DKT I 019 DGN	✓	✓	62	3	25	25	23,5	150	47	25	35	40	DGN-3	M8X27		
DKT I 020 DGN	✓	✓	62	4	25	25	23	150	47	25	35	40	DGN-4			

DKT K

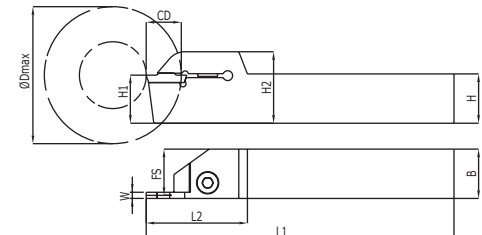

Kesici Uç Uyumluluğu Insert Suitability	Stok / Stock		Takım Ölçüleri / Dimension (mm)										Uç Insert	Vida Screw	Anahtar Allen Key
	R	L	Dmax	W	H	B	FS	L1	L2	H1	H2	CD			
KRL Y MGM															
DKT K 001 MGM.	✓	✓	62	2	12	12	11	90	31	12	24	16	MGM.2	M5X16	A4
DKT K 002 MGM.	✓	✓	62	2	16	16	15	125	41	16	28,5	17			
DKT K 003 MGM.	✓	✓	62	2	20	20	19	125	41	20	28,5	17			
DKT K 004 MGM.	✓	✓	62	2	25	25	24	150	45	25	35	18	MGM.3	M5X16	
DKT K 005 MGM.	✓	✗	62	2	32	32	31	170	45	32	42	21			
DKT K 006 MGM.	✓	✓	62	3	12	12	10,5	90	31	12	24	16			
DKT K 007 MGM.	✓	✓	62	3	16	16	14,5	125	41	16	28,5	18	MGM.4	M8X27	
DKT K 008 MGM.	✓	✓	62	3	20	20	18,5	125	41	20	28,5	18			
DKT K 009 MGM.	✓	✓	62	3	25	25	23,5	150	45	25	35	21			
DKT K 010 MGM.	✓	✗	62	3	32	32	30,5	170	45	32	42	23	MGM.5	M8X27	
DKT K 011 MGM.	✓	✓	62	4	16	16	14	125	41	16	28,5	18			
DKT K 012 MGM.	✓	✓	62	4	20	20	18	125	41	20	28,5	18			
DKT K 013 MGM.	✓	✓	62	4	25	25	23	150	45	25	35	23	MGM.6	M8X27	
DKT K 014 MGM.	✓	✗	62	4	32	32	30	170	45	32	42	25			M5X16
DKT K 015 MGM.	✓	✓	62	5	20	20	17,5	125	41	20	28,5	21			
DKT K 016 MGM.	✓	✓	62	5	25	25	22,5	150	45	25	35	23	MGM.1,5	M8X27	
DKT K 017 MGM.	✓	✓	62	5	32	32	29,5	170	45	32	42	25			M5X16
DKT K 018 MGM.	✓	✓	62	6	25	25	22	150	45	25	35	23			
DKT K 019 MGM.	✓	✓	62	6	32	32	29	170	45	32	42	25	MGM.4	M8X27	
DKT K 020 MGM.	✓	✓	62	1,5	16	16	14,5	125	41	16	28,5	17			M5X16
DKT K 022 MGM.	✓	✓	62	1,5	20	20	18,5	125	41	20	28,5	17			
DKT K 023 MGM.	✓	✓	62	4	25	25	23	150	45	25	35	40	MGM.4	M8X27	
DKT K 028 MGM.	✓	✓	62	3	25	25	22	150	45	25	35	30	MGM.3		
DKT K 029 MGM.	✓	✓	62	4	25	25	23	150	45	25	35	30	MGM.4		
DKT K 030 MGM.	✓	✓	62	3	25	25	23,5	150	45	25	35	40	MGM.3		
DKT K 031 MGM.	✓	✓	62	5	25	25	22,5	150	45	25	35	40	MGM.5		

DKT H

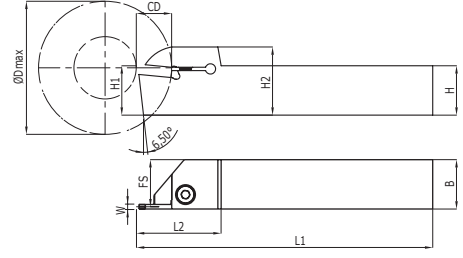
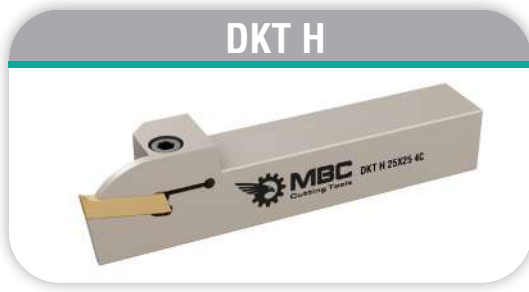

Kesici Uç Uyumluluğu Insert Suitability	Stok / Stock		Takım Ölçüleri / Dimension (mm)										Uç Insert	Vida Screw	Anahtar Allen Key
	R	L	Dmax	W	H	B	FS	L1	L2	H1	H2	CD			
S229 HRN															
DKT H 001 S229	✓	✓	62	3	16	16	14,5	125	46	16	24	17	S229-3		
DKT H 002 S229	✓	✓	62	3	20	20	18,5	125	46	20	28,5	22			
DKT H 003 S229	✓	✓	62	3	25	25	23,5	150	46	25	35	23			
DKT H 004 S229	✓	X	62	3	32	32	30,5	170	46	32	42	24	S229-4		
DKT H 005 S229	✓	✓	62	4	20	20	18	125	46	20	28,5	22			
DKT H 006 S229	✓	✓	62	4	25	25	23	150	46	25	35	23			
DKT H 007 S229	✓	X	62	4	32	32	30	170	46	32	42	24	S229-5		
DKT H 008 S229	✓	✓	62	5	20	20	17,5	125	46	20	28,5	22			
DKT H 009 S229	✓	✓	62	5	25	25	22,5	150	46	25	35	23			
DKT H 010 S229	✓	X	62	5	32	32	27,5	170	46	32	42	24	S229-6		
DKT H 011 S229	✓	✓	62	6	25	25	22	150	46	25	35	23			

DKT HK

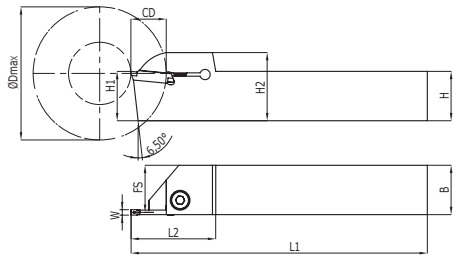

Kesici Uç Uyumluluğu Insert Suitability	Stok / Stock		Takım Ölçüleri / Dimension (mm)										Uç Insert	Vida Screw	Anahtar Allen Key
	R	L	Dmax	W	H	B	FS	L1	L2	H1	H2	CD			
S224 HRN															
DKT HK 001 S224	✓	✓	62	2	16	16	15	125	43	16	28	18	S224-2		
DKT HK 002 S224	✓	✓	62	2	20	20	19	125	43	20	28	18			
DKT HK 003 S224	✓	✓	62	2	25	25	24	150	43	25	35	21			
DKT HK 004 S224	✓	✓	62	3	16	16	14,5	125	43	16	28	18	S224-3		
DKT HK 005 S224	✓	✓	62	3	20	20	18,5	125	43	20	28	18			
DKT HK 006 S224	✓	✓	62	3	25	25	23,5	150	43	25	35	21			
DKT HK 007 S224	✓	X	62	3	32	32	30,5	170	46	32	42	24	S224-4		
DKT HK 008 S224	✓	✓	62	4	16	16	14	125	43	16	28	18			
DKT HK 009 S224	✓	✓	62	4	20	20	18	125	43	20	28	18			
DKT HK 010 S224	✓	✓	62	4	25	25	23	150	43	25	35	21	S224-4		
DKT HK 011 S224	✓	X	62	4	32	32	30	170	46	32	42	24			

DKT TT

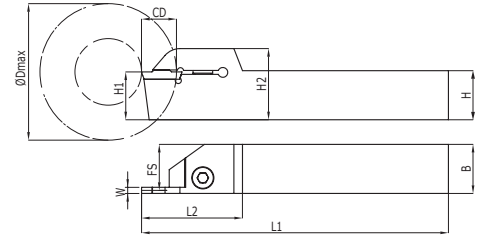

Kesici Uç Uyumluluğu Insert Suitability	Stok / Stock		Takım Ölçüleri / Dimension (mm)										Uç Insert	Vida Screw	Anahtar Allen Key		
	R	L	Dmax	W	H	B	FS	L1	L2	H1	H2	CD					
TD.. TGTC																	
DKT TT 001 TD..	✓	X	62	2	12	12	11	90	31	12	24	16	TD..2	M5X16	A4		
DKT TT 002 TD..	✓	✓	62	2	16	16	15	125	41	16	28,5	18					
DKT TT 003 TD..	✓	✓	62	2	20	20	19	125	41	20	28,5	18					
DKT TT 004 TD..	✓	✓	62	2	25	25	24	150	45	25	35	18	TD..3	M5X16			
DKT TT 005 TD..	✓	X	62	3	12	12	10,5	90	31	12	24	16					
DKT TT 006 TD..	✓	✓	62	3	16	16	14,5	125	41	16	28,5	18					
DKT TT 007 TD..	✓	✓	62	3	20	20	18,5	125	41	20	28,5	18	TD..4	M8X27			
DKT TT 008 TD..	✓	✓	62	3	25	25	23,5	150	45	25	35	21					
DKT TT 009 TD..	✓	X	62	3	32	32	30,5	170	45	32	42	23					
DKT TT 010 TD..	✓	✓	62	4	16	16	14	125	41	16	28,5	18	TD..5	M8X27			
DKT TT 011 TD..	✓	✓	62	4	20	20	18	125	41	20	28,5	18					
DKT TT 012 TD..	✓	✓	62	4	25	25	23	150	45	25	35	21					
DKT TT 013 TD..	✓	X	62	4	32	32	30	170	45	32	42	23					
DKT TT 014 TD..	✓	✓	62	5	25	25	22,5	150	45	25	35	21					

DKT ZCC2

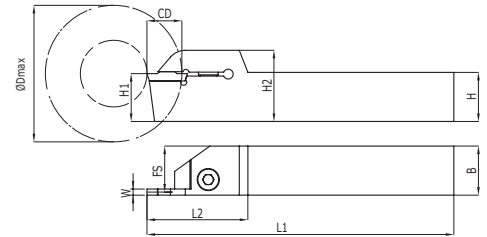

Kesici Uç Uyumluluğu Insert Suitability	Stok / Stock		Takım Ölçüleri / Dimension (mm)										Uç Insert	Vida Screw	Anahtar Allen Key	
	R	L	Dmax	W	H	B	FS	L1	L2	H1	H2	CD				
ZCC ZT.D																
DKT ZCC2 001 ZT.D	✓	✓	62	2	20	20	19	125	41	20	28,5	17	ZT.D2	M8X27	A4	
DKT ZCC2 002 ZT.D	✓	✓	62	2	25	25	24	150	45	25	35	21				
DKT ZCC2 003 ZT.D	✓	✓	62	2,5	16	16	14,75	125	41	16	24,5	17	ZT.D5			
DKT ZCC2 004 ZT.D	✓	✓	62	2,5	20	20	18,75	125	41	20	28,5	17				
DKT ZCC2 005 ZT.D	✓	✓	62	2,5	25	25	23,75	150	45	25	35	21	ZT.D3			
DKT ZCC2 006 ZT.D	✓	✓	62	3	16	16	14,5	125	41	16	24,5	18				
DKT ZCC2 007 ZT.D	✓	✓	62	3	20	20	18,5	125	41	20	28,5	18	ZT.D4			
DKT ZCC2 008 ZT.D	✓	✓	62	3	25	25	23,5	150	45	25	35	21				
DKT ZCC2 009 ZT.D	✓	✓	62	4	16	16	14	125	41	16	24,5	18	ZT.D5			
DKT ZCC2 010 ZT.D	✓	✓	62	4	20	20	18	125	41	20	28,5	18				
DKT ZCC2 011 ZT.D	✓	✓	62	4	25	25	23	150	45	25	35	21	ZT.D6			
DKT ZCC2 012 ZT.D	✓	X	62	4	32	32	30	170	45	32	42	23				
DKT ZCC2 013 ZT.D	✓	✓	62	5	16	16	13,5	125	41	16	24,5	21	ZT.D5			
DKT ZCC2 014 ZT.D	✓	✓	62	5	20	20	17,5	125	41	20	28,5	21				
DKT ZCC2 015 ZT.D	✓	✓	62	5	25	25	22,5	150	45	25	35	21	ZT.D2			
DKT ZCC2 016 ZT.D	✓	X	62	5	32	32	29,5	170	45	32	42	23				
DKT ZCC2 017 ZT.D	X	X	62	6	20	20	17	125	41	20	28,5	21				
DKT ZCC2 018 ZT.D	✓	X	62	6	25	25	22	150	45	25	35	21				
DKT ZCC2 019 ZT.D	✓	X	62	6	32	32	29	170	45	32	42	23				
DKT ZCC2 020 ZT.D	✓	✓	62	2,5	20	20	18,75	125	41	20	28,5	18				
DKT ZCC2 021 ZT.D	✓	✓	62	2	16	16	15	125	41	16	24,5	18				

DKT KYC

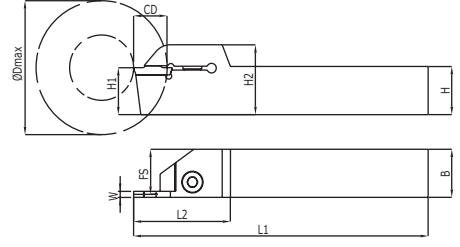

Kesici Uç Uyumluluğu Insert Suitability	Stok / Stock		Takım Ölçüleri / Dimension (mm)										Uç Insert	Vida Screw	Anahtar Allen Key								
	R	L	Dmax	W	H	B	FS	L1	L2	H1	H2	CD											
KYC GDM																							
DKT KY 001 GDM	✓	✓	62	2	12	12	11	125	41	12	20,5	12	GDM.2	M8X27	A4								
DKT KY 002 GDM	✓	✓	62	2	16	16	15	125	41	16	24,5	17											
DKT KY 003 GDM	✓	✓	62	2	20	20	19	125	41	20	28,5	17											
DKT KY 004 GDM	✓	✓	62	2	25	25	24	150	45	25	35	18											
DKT KY 005 GDM	✓	✓	62	3	12	12	10,5	125	41	12	20,5	12	GDM.3			M8X27	A4						
DKT KY 006 GDM	✓	✓	62	3	16	16	14,5	125	41	16	24,5	20											
DKT KY 007 GDM	✓	✓	62	3	20	20	18,5	125	43	20	28,5	20											
DKT KY 008 GDM	✓	✓	62	3	25	25	23,5	150	45	25	35	21	GDM.4					M8X27	A4				
DKT KY 009 GDM	✓	✓	62	4	16	16	15	125	41	16	24,5	17											
DKT KY 010 GDM	✓	✓	62	2	20	20	19	125	41	20	28,5	17	GDM.2							M8X27	A4		
DKT KY 011 GDM	✓	X	62	2	25	25	24	150	45	25	35	10											
DKT KY 012 GDM	✓	X	62	3	25	25	23,5	150	45	25	35	25	GDM.3									M8X27	A4
DKT KY 013 GDM	✓	X	62	4	25	25	23	150	45	25	35	25											
DKT KY 014 GDM	✓	✓	62	2	16	16	15	125	41	16	24,5	17	GDM.2	M8X27	A4								

DKT SND

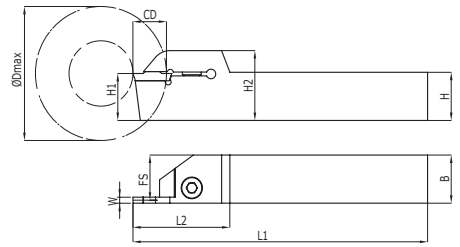

Kesici Uç Uyumluluğu Insert Suitability	Stok / Stock		Takım Ölçüleri / Dimension (mm)										Uç Insert	Vida Screw	Anahtar Allen Key												
	R	L	Dmax	W	H	B	FS	L1	L2	H1	H2	CD															
SND N123																											
DKT SND 001 N123	✓	✓	62	2	12	12	11	125	41	12	20,5	12	N123-2C	M8X27	A4												
DKT SND 002 N123	✓	✓	62	3	12	12	10,5	125	41	12	20,5	12	N123-3C			M8X27	A4										
DKT SND 003 N123	✓	✓	62	2	20	20	19	125	41	20	28,5	18	N123-2C					M8X27	A4								
DKT SND 004 N123	✓	✓	62	2	25	25	24	150	45	25	35	21															
DKT SND 007 N123	✓	✓	62	3	20	20	18,5	125	41	20	28,5	18	N123-3C							M8X27	A4						
DKT SND 008 N123	✓	✓	62	3	25	25	23,5	150	45	25	35	21															
DKT SND 011 N123	✓	✓	62	4	20	20	18	125	41	20	28,5	20	N123-4C									M8X27	A4				
DKT SND 012 N123	✓	✓	62	4	25	25	23	150	45	25	35	21															
DKT SND 014 N123	✓	✓	62	5	20	20	17,5	125	41	20	28,5	21	N123-5C											M8X27	A4		
DKT SND 015 N123	✓	✓	62	5	25	25	22,5	150	45	25	35	23															
DKT SND 016 N123	✓	X	62	5	32	32	29,5	170	45	32	42	24	N123-1,5C													M8X27	A4
DKT SND 019 N123	✓	✓	62	1,5	25	25	24,25	150	45	25	35	18															
DKT SND 020 N123	✓	✓	62	1,5	16	16	14,5	125	41	16	24,5	17															
DKT SND 021 N123	✓	✓	62	1,5	20	20	18,5	125	41	20	28,5	17	N123-2C	M8X27	A4												
DKT SND 022 N123	✓	✓	62	2	16	16	15	125	41	16	24,5	18															

DKT KM

NEW

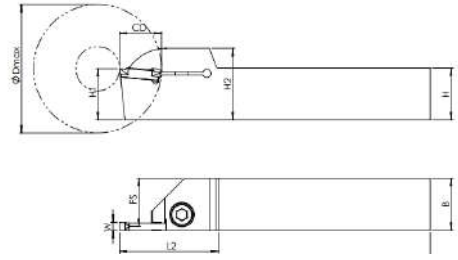

Kesici Uç Uyumluluğu Insert Suitability	Stok / Stock		Takım Ölçüleri / Dimension (mm)										Uç Insert	Vida Screw	Anahtar Allen Key		
	R	L	Dmax	W	H	B	FS	L1	L2	H1	H2	CD					
KM GMN																	
DKT KM 003 GMN	✓	✓	62	2	16	16	15	125	41	16	28	17	GMN.2	M8X27	A4		
DKT KM 004 GMN	✓	✓	62	2	20	20	19	125	41	20	28,5	20					
DKT KM 005 GMN	✓	✓	62	3	20	20	18,5	125	41	20	28,5	20					
DKT KM 006 GMN	✓	✓	62	4	20	20	18	125	41	20	28,5	20					
DKT KM 007 GMN	✓	✓	62	2	25	25	24	150	45	25	35	22					
DKT KM 008 GMN	✓	✓	62	3	25	25	23,5	150	45	25	35	22					
DKT KM 009 GMN	✓	✓	62	4	25	25	23	150	45	25	35	22					
DKT KM 010 GMN	✓	✓	62	5	25	25	22,5	150	45	25	35	22					
DKT KM 011 GMN	✓	✓	62	6	25	25	22	150	45	25	35	22					

DKT TNG

NEW

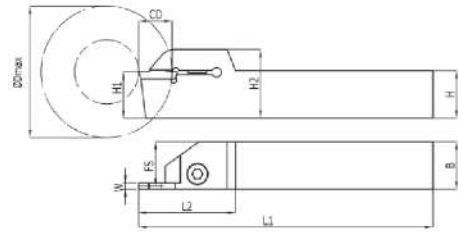

Kesici Uç Uyumluluğu Insert Suitability	Stok / Stock		Takım Ölçüleri / Dimension (mm)										Uç Insert	Vida Screw	Anahtar Allen Key	
	R	L	Dmax	W	H	B	FS	L1	L2	H1	H2	CD				
TNG																
DKT TNG 001 TNG	✓	✓	62	2	16	16	15	125	41	16	28	17	GMN.2	M8X27	A4	
DKT TNG 002 TNG	✓	✓	62	2	20	20	19	125	41	20	28,5	20				
DKT TNG 003 TNG	✓	✓	62	2	25	25	24	150	45	25	35	22				

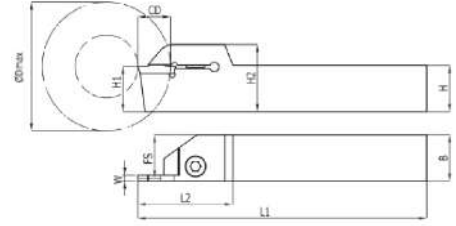

Kesici Uç Uyumluluğu Insert Suitability	Stok / Stock		Takım Ölçüleri / Dimension (mm)											Uç Insert	Vida Screw	Anahtar Allen Key	
	R	L	Dmax	W	H	B	FS	L1	L2	H1	H2	CD					
DKT VRG																	
DKT VG 001 VRG	✓	X	62	2	20	20	19	125	41	20	28,5	20	VGD.2	M8X27	A4		
DKT VG 002 VRG	✓	X	62	3	20	20	18,5	125	41	20	28,5	20	VGD.3				
DKT VG 003 VRG	✓	X	62	2	25	25	24	150	45	25	35	22	VGD.2				
DKT VG 004 VRG	✓	X	62	3	25	25	23,5	150	45	25	35	22	VGD.3				
DKT VG 005 VRG	✓	X	62	4	25	25	23	150	45	25	35	22	VGD.4				
DKT VG 006 VRG	✓	X	62	3	32	32	30,5	170	45	32	42	24	VGD.3				
DKT VG 007 VRG	✓	X	62	4	32	32	30	170	45	32	42	24	VGD.4				

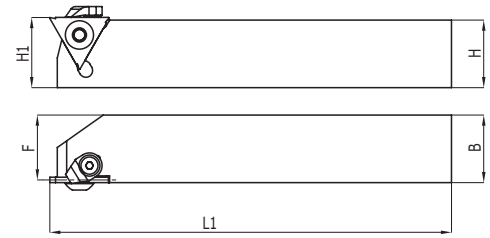

Kesici Uç Uyumluluğu Insert Suitability	Stok / Stock		Takım Ölçüleri / Dimension (mm)							Uç Insert	Vida Screw	Pabuç Clamp	Vida Screw	Anahtar Torx Key	Anahtar Allen Key
	H1	H	B	F	L1	L2	AS	Y0							
HRN S312															
DKT H 360 001 S312	✓		16	16	15,5	125	-	0	0	S312-1	M5X12 A3	C110105	M4X10	T15	A3
DKT H 360 002 S312	✓		20	20	19,5	125	-	0	0	S312-1					
DKT H 360 003 S312	✓		25	25	24,5	150	-	0	0	S312-1					
DKT H 360 004 S312	✓		16	16	15	125	-	0	0	S312-2					
DKT H 360 005 S312	✓		20	20	19	125	-	0	0	S312-2					
DKT H 360 006 S312	✓		25	25	24	150	-	0	0	S312-2					
DKT H 360 007 S312	✓		16	16	14,5	125	-	0	0	S312-3					
DKT H 360 008 S312	✓		20	20	18,5	125	-	0	0	S312-3					
DKT H 360 009 S312	✓		25	25	23,5	150	-	0	0	S312-3					

ALIN KANAL KATERİ

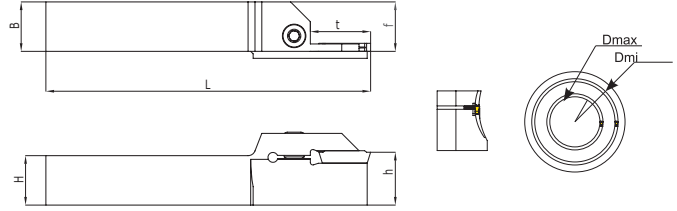

Kesici Uç Uyumluluđu Insert Suitability	Stok / Stock		Takım Ölçüleri / Dimension (mm)								Uç Insert	Vida Screw	Anahtar Allen Key
	R	L	Dmin	Dmax	H	B	f	L1	h	t max			
KRLY MGM													
AKT K 001 MGM.	✓	✗	30	40	25	25	26,7	150	25	17,5	KRLY MGM. 300	M8X27	A4
AKT K 002 MGM.	✓	✗	35	50	25	25	26,7	150	25	17,5			
AKT K 003 MGM.	✓	✗	45	70	25	25	26,7	150	25	17,5			
AKT K 004 MGM.	✓	✗	65	105	25	25	26,7	150	25	17,5			
AKT K 005 MGM.	✓	✗	100	150	25	25	26,7	150	25	17,5			
AKT K 006 MGM.	✓	✗	30	40	25	25	26,8	150	25	17,5	KRLY MGM. 400		
AKT K 007 MGM.	✓	✗	35	50	25	25	26,8	150	25	17,5			
AKT K 008 MGM.	✓	✗	45	70	25	25	26,8	150	25	17,5			
AKT K 009 MGM.	✓	✗	65	105	25	25	26,8	150	25	17,5			
AKT K 010 MGM.	✓	✗	100	150	25	25	26,8	150	25	17,5			
AKT K 011 MGM.	✓	✗	75	110	25	25	27	150	25	17,5	KRLY MGM. 500		
AKT K 012 MGM.	✓	✗	105	150	25	25	27	150	25	17,5			
AKT K 013 MGM.	✓	✗	145	200	25	25	27	150	25	17,5			

ALIN KANAL KATERİ

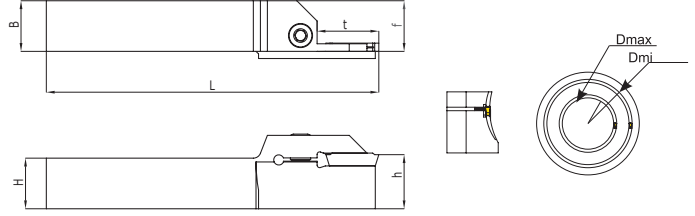

Kesici Uç Uyumluluğu Insert Suitability	Stok / Stock		Takım Ölçüleri / Dimension (mm)								Uç İnsert	Vida Screw	Anahtar Allen Key	
	R	L	Dmin	Dmax	H	B	f	L1	h	t max				
ZCC ZT.D														
AKT ZCC 001	✓	✗	25	35	25	25	27	150	25	17	ZT.D3	M8X27	A4	
AKT ZCC 002	✓	✗	35	45	25	25	27	150	25	17				
AKT ZCC 003	✓	✗	39	55	25	25	27	150	25	17				
AKT ZCC 004	✓	✗	49	80	25	25	27	150	25	17				
AKT ZCC 005	✓	✓	70	110	25	25	27	150	25	17				
AKT ZCC 006	✓	✗	100	150	25	25	27	150	25	17				
AKT ZCC 007	✓	✗	40	60	25	25	27	150	25	22	ZT.D4			
AKT ZCC 008	✓	✗	52	80	25	25	27	150	25	22				
AKT ZCC 009	✓	✗	72	110	25	25	27	150	25	22				
AKT ZCC 010	✓	✗	100	150	25	25	27	150	25	22	ZT.D5			
AKT ZCC 011	✓	✗	140	200	25	25	27	150	25	22				
AKT ZCC 012	✓	✗	55	95	25	25	27	150	25	25	ZT.D3			
AKT ZCC 013	✓	✗	85	140	25	25	27	150	25	25				
AKT ZCC 014	✓	✗	130	200	25	25	27	150	25	25	ZT.D6			
AKT ZCC 015	✓	✗	70	110	25	25	27	150	25	17				
AKT ZCC 016	✓	✗	88	180	25	25	27	150	25	32	ZT.D3			
AKT ZCC 017	✓	✓	120	240	25	25	27	150	25	38				
AKT ZCC 018	✓	✓	70	110	25	25	27	150	25	10				

ALIN KANAL KATERİ

NEW

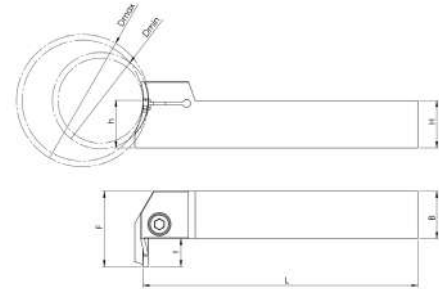

Kesici Uç Uyumluluğu Insert Suitability	Stok / Stock		Takım Ölçüleri / Dimension (mm)								Uç İnsert	Vida Screw	Anahtar Allen Key
	R	L	Dmin	Dmax	H	B	f	L1	h	t max			
K MGMN													
LKT K 001 KRLY MGMN	✓	✗	30	40	25	25	39	150	25	14	MGM.3	M8X27	A4
LKT K 002 KRLY MGMN	✓	✗	35	50	25	25	39	150	25	14			
LKT K 003 KRLY MGMN	✓	✗	45	70	25	25	39	150	25	14			
LKT K 004 KRLY MGMN	✓	✗	65	105	25	25	39	150	25	14			
LKT K 005 KRLY MGMN	✓	✗	100	150	25	25	39	150	25	14			
LKT K 006 KRLY MGMN	✓	✗	150	200	25	25	39	150	25	14			
LKT K 007 KRLY MGMN	✓	✗	200	300	25	25	39	150	25	14			
LKT K 008 KRLY MGMN	✓	✗	300	500	25	25	39	150	25	14			
LKT K 009 KRLY MGMN	✓	✗	35	50	25	25	42	150	25	17			
LKT K 010 KRLY MGMN	✓	✗	45	70	25	25	42	150	25	17			
LKT K 011 KRLY MGMN	✓	✗	65	105	25	25	42	150	25	17			
LKT K 012 KRLY MGMN	✓	✗	100	150	25	25	42	150	25	17			
LKT K 013 KRLY MGMN	✓	✗	150	200	25	25	42	150	25	17			

Lütfen Sipariş vermeden önce stok durumunu sorunuz.
Please ask before ordering, stock status.

L: Sol / Left

R: Sağ / Right

✓ Stokta / In Stock

✗ Stokta Yok / Non Stock

DKT I KAYAR OTOMAT

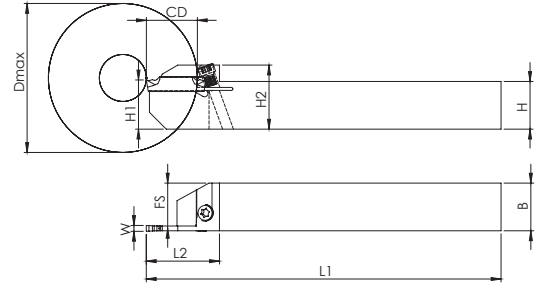

Kesici Uç Uyumluluğu Insert Suitability	Stok / Stock		Takım Ölçüleri / Dimension (mm)										Uç İnsert	Vida Screw	Anahtar Allen Key	
	DGN	R	L	Dmax	W	H	B	FS	L1	L2	H1	H2	CD			
DKT I 001 DGN KAYAR OT	✓	✓		50	1,5	10	10	9,25	125	30	10	21	12	DGN-1,5	M4X11	T15
DKT I 002 DGN KAYAR OT	✓	✓		50	1,5	12	12	11,25	125	30	12	21	12			
DKT I 003 DGN KAYAR OT	✓	✓		50	1,5	16	16	15,25	125	30	16	21	15			
DKT I 004 DGN KAYAR OT	✓	✓		50	2	12	12	11	125	30	12	21	12	DGN-2		
DKT I 005 DGN KAYAR OT	✓	✓		50	2	16	16	15	125	30	16	21	15			
DKT I 006 DGN KAYAR OT	✓	✓		50	3	16	16	14,5	125	30	16	21	15	DGN-3		
DKT I 007 DGN KAYAR OT	✓	✓		50	3	12	12	10,5	125	30	12	21	12			

DKT SND KAYAR OTOMAT

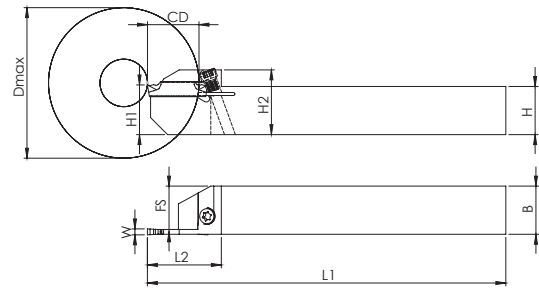

Kesici Uç Uyumluluğu Insert Suitability	Stok / Stock		Takım Ölçüleri / Dimension (mm)										Uç İnsert	Vida Screw	Anahtar Allen Key	
	SND N123	R	L	Dmax	W	H	B	FS	L1	L2	H1	H2	CD			
DKT SND 000 N123 OT	✓	✓		50	1,5	10	10	8,5	125	30	10	21	12	N123-1,5C	M4X11	T15
DKT SND 001 N123 OT	✓	✓		50	1,5	12	12	11,25	125	30	12	21	12			
DKT SND 002 N123 OT	✓	✓		50	1,5	16	16	15,25	125	30	16	21	15			
DKT SND 003 N123 OT	✓	✓		50	2	12	12	11,25	125	30	12	21	12	N123-2C		
DKT SND 005 N123 OT	✓	✓		50	3	12	12	11,25	125	30	12	21	12			

DKT KY KAYAR OTOMAT

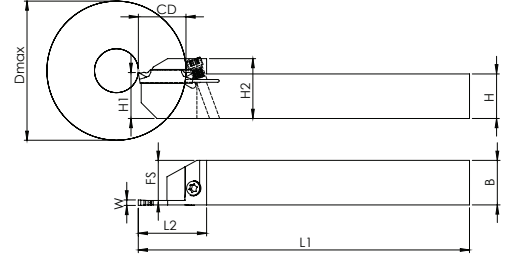

Kesici Uç Uyumluluğu Insert Suitability	Stok / Stock		Takım Ölçüleri / Dimension (mm)										Uç İnsert	Vida Screw	Anahtar Allen Key	
	R	L	Dmax	W	H	B	FS	L1	L2	H1	H2	CD				
KYC GDM																
DKT KY 001 GDM OT	✓	✓	50	2	10	10	9	125	30	10	21	12	GDM.2	M4X11	T15	
DKT KY 002 GDM OT	✓	✓	50	2	12	12	11	125	30	12	21	12				
DKT KY 003 GDM OT	✓	✓	50	2	16	16	15	125	30	16	21	15	GDM.3	M4X11	T15	
DKT KY 004 GDM OT	✓	✓	50	3	12	12	10,5	125	30	12	21	12				
DKT KY 005 GDM OT	✓	✓	50	3	16	16	14,5	125	30	16	21	15				

DKT ZCC KAYAR OTOMAT

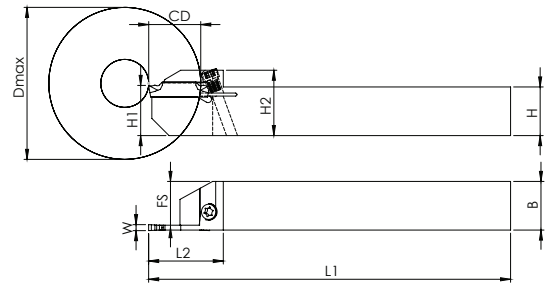

Kesici Uç Uyumluluğu Insert Suitability	Stok / Stock		Takım Ölçüleri / Dimension (mm)										Uç İnsert	Vida Screw	Anahtar Allen Key
	R	L	Dmax	W	H	B	FS	L1	L2	H1	H2	CD			
ZCC															
DKT ZCC2 003 OT	✓	✓	50	2	12	12	11	125	30	12	21	12	ZT. D2	M4X11	T15
DKT ZCC2 004 OT	✓	✓	50	2	16	16	15	125	30	16	21	15			
DKT ZCC2 005 OT	✓	✓	50	3	16	16	14,5	125	30	16	21	15	ZT. D3	M4X11	T15
DKT ZCC2 006 OT	✓	✓	50	3	12	12	10,5	125	30	12	21	12			



İÇ KANAL KATERLERİ

INTERNAL GROOVING TOOLHOLDERS

IKT K

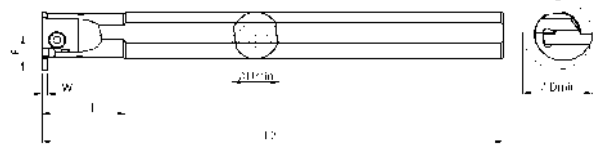

Kesici Uç Uyumluluğu Insert Suitability	Stok / Stock	Takım Ölçüleri / Dimension (mm)						Uç İnsert	Vida Screw	Anahtar Allen Key
		D	D min	F	L1	L2	W			
MGM KRLY										
IKT K 001 MGM	✓	16	20	12	180	25	2	MGM.-2	M4X12	A3
IKT K 002 MGM	✓	20	25	14	200	30	2			
IKT K 003 MGM	✓	25	31	18	250	35	2			
IKT K 004 MGM	✓	32	39	22	250	30	2	MGM.-3	M8X27	A4
IKT K 005 MGM	✓	20	25	14,5	200	30	3			
IKT K 006 MGM	✓	25	32	18,5	250	35	3			
IKT K 007 MGM	✓	32	42	25	250	35	3	MGM.-4	M6X16	A5
IKT K 008 MGM	✓	20	25	14,5	200	30	4			
IKT K 009 MGM	✓	25	32	18,5	250	30	4			
IKT K 010 MGM	✓	32	42	25	250	35	4	MGM.-5	M8X27	A4
IKT K 011 MGM	✓	40	52	30	350	60	3			
IKT K 012 MGM	✓	40	52	30	350	60	4			
IKT K 013 MGM	✓	40	52	30	350	60	5	MGM.-5	M6X16	A5
IKT K 014 MGM	✓	32	42	25	250	35	5			
IKT K 015 MGM	✓	25	32	18,5	250	30	5			

IKT I

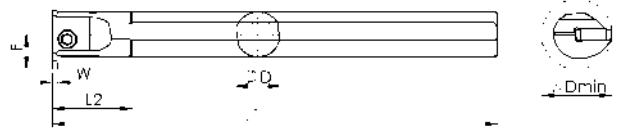

Kesici Uç Uyumluluğu Insert Suitability	Stok / Stock	Takım Ölçüleri / Dimension (mm)						Uç İnsert	Vida Screw	Anahtar Allen Key
		D	D min	F	L1	L2	W			
DGN										
IKT I 000 DGN.	✓	16	20	12	180	25	1,5	DGN-1,5	M4X12	A3
IKT I 001 DGN.	✓	20	25	14	200	30	2			
IKT I 002 DGN.	✓	25	32	18,5	250	40	2	DGN-2	M6X16	A5
IKT I 003 DGN.	✓	32	41	24,5	250	45	2			
IKT I 004 DGN.	✓	20	25	14	200	30	3	DGN-3	M4X12	A3
IKT I 005 DGN.	✓	25	32	18,5	250	40	3			
IKT I 006 DGN.	✓	32	41	24,5	250	45	3			
IKT I 007 DGN.	✓	20	25	14	200	30	4	DGN-4	M4X12	A3
IKT I 008 DGN.	✓	25	32	18,5	250	40	4			
IKT I 009 DGN.	✓	32	41	24,5	350	45	4			

IKT HK

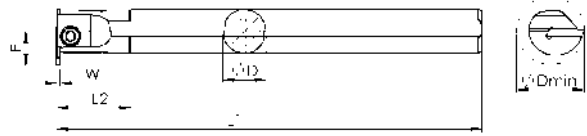

Kesici Uç Uyumluluğu Insert Suitability	Stok / Stock	Takım Ölçüleri / Dimension (mm)						Uç Insert	Vida Screw	Anahtar Allen Key
		D	D min	F	L1	L2	W			
HRN S224										
IKT HK 001 S224	✓	20	25	14	200	30	2	S224-2	M4X12	A3
IKT HK 002 S224	✓	25	33	19	250	40	2		M6X16	A5
IKT HK 003 S224	✓	32	40	23	250	45	2		M8X27	A4
IKT HK 004 S224	✓	20	25	14	200	30	3	S224-3	M4X12	A3
IKT HK 005 S224	✓	25	33	19	250	40	3		M6X16	A5
IKT HK 006 S224	✓	32	40	23	250	45	3		M8X27	A4
IKT HK 007 S224	✓	20	25	14	200	30	4	S224-4	M4X12	A3
IKT HK 008 S224	✓	25	33	19	250	40	4		M6X16	A5
IKT HK 009 S224	✓	32	40	23	350	45	4		M8X27	A4

IKT H

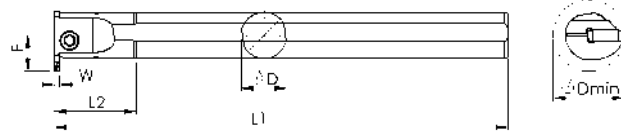

Kesici Uç Uyumluluğu Insert Suitability	Stok / Stock	Takım Ölçüleri / Dimension (mm)						Uç Insert	Vida Screw	Anahtar Allen Key
		D	D min	F	L1	L2	W			
HRN S229										
IKT H 001 S229	✓	25	34	20,5	250	40	3	S229-3	M6X16	A5
IKT H 002 S229	✓	32	43	26	250	45	3		M8X27	A4
IKT H 003 S229	✓	40	52	30	350	60	3			
IKT H 004 S229	✓	25	34	20,5	250	40	4	S229-4	M6X16	A5
IKT H 005 S229	✓	32	43	26	250	45	4		M8X27	A4
IKT H 006 S229	✓	40	52	30	350	60	4			
IKT H 007 S229	✓	25	34	20,5	250	40	5	S229-5	M6X16	A5
IKT H 008 S229	✓	32	43	26	250	45	5		M8X27	A4
IKT H 009 S229	✓	40	52	30	350	60	5			

IKT ZCC2

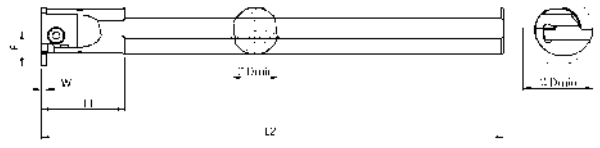

Kesici Uç Uyumluluğu Insert Suitability	Stok / Stock	Takım Ölçüleri / Dimension (mm)						Uç Insert	Vida Screw	Anahtar Allen Key
		D	D min	F	L1	L2	W			
ZCC ZT.D										
IKT ZCC2 001 ZT.D	✓	21	25	14,5	200	3	1,5	ZT.D-3	M4X12	A3
IKT ZCC2 002 ZT.D	✓	25	32	18,5	250	3	2		M6X16	A5
IKT ZCC2 003 ZT.D	✓	32	42	25	250	3	2		M8X27	A4
IKT ZCC2 004 ZT.D	✓	25	32	18,5	250	4	2	ZT.D-4	M6X16	A5
IKT ZCC2 005 ZT.D	✓	32	42	25	250	4	3		ZT.D-5	M8X27
IKT ZCC2 006 ZT.D	✓	32	42	25	250	5	3			
IKT ZCC2 007 ZT.D	✓	40	52	30	350	5	3			
IKT ZCC2 008 ZT.D	✓	25	32	18,5	250	2	4	ZT.D-2	M6X16	A5
IKT ZCC2 009 ZT.D	✓	16	20	12	180	2	4		M4X12	A3
IKT ZCC2 010 ZT.D	✓	20	25	14,5	200	2	4			

IKT SND

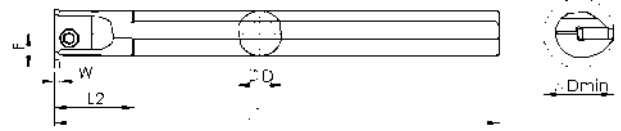

Kesici Uç Uyumluluğu Insert Suitability	Stok / Stock	Takım Ölçüleri / Dimension (mm)						Uç Insert	Vida Screw	Anahtar Allen Key
		D	D min	F	L1	L2	W			
SND ZCC										
IKT SND 001 SND	✓	20	25	14,5	200	30	3	N123-3C	M6X16	A5
IKT SND 002 SND	✓	25	32	18,5	250	35	3		M8X27	A4
IKT SND 003 SND	✓	32	42	25	250	35	3			
IKT SND 004 SND	✓	25	32	18,5	250	30	4	N123-4C	M6X16	A5
IKT SND 005 SND	✓	32	42	25	250	35	4		M8X27	A4
IKT SND 007 SND	✓	20	25	14	200	30	2	N123-2C		
IKT SND 008 SND	✓	25	32	18	250	35	2		M6X16	A5

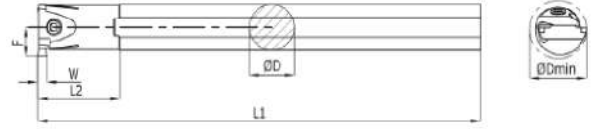

Kesici Uç Uyumluluğu Insert Suitability	Stok / Stock	Takım Ölçüleri / Dimension (mm)						Uç İnsert	Vida Screw	Anahtar Allen Key
		D	D min	F	L1	L2	W			
GRP I										
IKT I GRP 001	✓	16	20	12	180	25	3	TGM.-3	M4X12	A3
IKT I GRP 002	✓	20	25	14	200	30	3			
IKT I GRP 003	✓	25	31	18	250	35	3		M6X16	A5

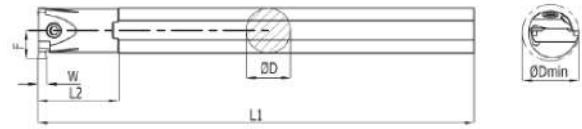

Kesici Uç Uyumluluğu Insert Suitability	Stok / Stock	Takım Ölçüleri / Dimension (mm)						Uç İnsert	Vida Screw	Anahtar Allen Key
		D	D min	F	L1	L2	W			
TGM ITG										
IKT ITG 001 TGM	✓	16	20	12	180	25	3	TGM.-3	M4X12	A3
IKT ITG 003 TGM	✓	20	25	14	200	30	3			
IKT ITG 005 TGM	✓	25	31	18	250	35	3		M6X16	A5
IKT ITG 007 TGM	✓	25	31	18	250	35	4	TGM.-4		
IKT ITG 009 TGM	✓	32	42	25	250	35	3	TGM.-3	M8X27	A4
IKT ITG 011 TGM	✓	32	42	25	250	35	4	TGM.-4		

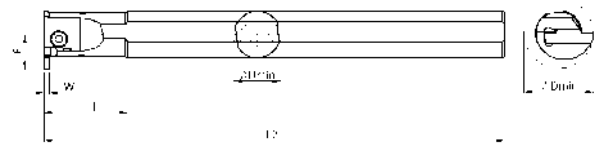

Kesici Uç Uyumluluğu Insert Suitability	Stok / Stock	Takım Ölçüleri / Dimension (mm)						Uç İnsert	Vida Screw	Anahtar Allen Key
		D	D min	F	L1	L2	W			
IKT KY										
IKT KY 001 GDM	✓	20	25	14	200	30	2	GDM.2	M4X10	A3
IKT KY 002 GDM	✓	20	25	14	200	30	3	GDM.3	M6X16	A5
IKT KY 003 GDM	✓	25	31	18	250	35	3			
IKT KY 004 GDM	✓	32	42	25	250	35	3	GDM.4	M8X16	A4
IKT KY 005 GDM	✓	32	42	25	250	35	4			
IKT KY 006 GDM	✓	40	52	30	350	60	4			
IKT KY 007 GDM	✓	25	31	24,5	250	35	4			
IKT KY 008 GDM	✓	32	42	28	350	60	4	GDM.2	M8X27	A3
IKT KY 009 GDM	✓	25	31	18	250	35	2			
IKT KY 010 GDM	✓	16	18	9,5	180	25	2	GDM.3	M4X10	A3
IKT KY 011 GDM	✓	16	18	9,5	180	25	3			
IKT KY 012 GDM	✓	20	25	14	200	30	2	GDM.3	M6X16	A5
IKT KY 013 GDM	✓	20	25	14	200	30	3			
IKT KY 015 GDM	✓	20	25	14	200	30	4	GDM.4	M6X16	A5
IKT KY 016 GDM	✓	25	31	18	250	35	4			
IKT KY 017 GDM	✓	25	31	18	250	35	3	GDM.3		

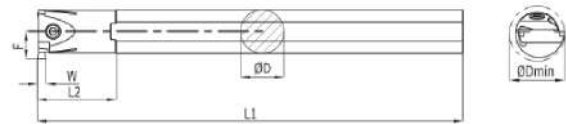

Kesici Uç Uyumluluğu Insert Suitability	Stok / Stock	Takım Ölçüleri / Dimension (mm)						Uç İnsert	Vida Screw	Anahtar Allen Key
		D	D min	F	L1	L2	W			
VRG VG										
IKT VG 001 VRG	✓	20	25	14	200	30	2	VGD.2	M4X12	A3
IKT VG 002 VRG	✓	20	25	14	200	30	3	VGD.3		
IKT VG 003 VRG	✓	25	31	18	250	35	2	VGD.2	M6X16	A5
IKT VG 004 VRG	✓	25	31	18	250	35	3	VGD.3		
IKT VG 005 VRG	✓	25	31	18	250	35	4	VGD.4	M8X27	A4
IKT VG 006 VRG	✓	32	42	25	250	35	2	VGD.2		
IKT VG 007 VRG	✓	32	42	25	250	35	3	VGD.3		
IKT VG 008 VRG	✓	32	42	25	250	35	4	VGD.4		

Lütfen Sipariş vermeden önce stok durumunu sorunuz.
Please ask before ordering, stock status.

L: Sol / Left

R: Sağ / Right

✓ Stokta / In Stock

✗ Stokta Yok / Non Stock



S-SİSTEM DIŞ ÇAP TORNALAMA KATERLER

S-SYSTEM EXTERNAL TURNING TOOLHOLDERS

SVJBR ISO

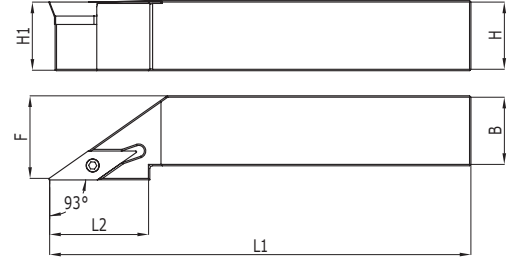

Kesici Uç Uyumluluğu Insert Suitability	Stok / Stock		Takım Ölçüleri / Dimension (mm)							Uç Insert	Altık Shim	Vida Screw	Vida Screw	Anahtar Torx Key
	R	L	H1	H	B	F	L1	L2	λS					
ISO														
SVJBR 001 ISO	✓	✓	12	12	20	100	20	0	0	VBM. 1103..	-	-	M2,5X7	T08
SVJBR 002 ISO	✓	✓	16	16	20	100	25	0	0	VBM. 1604..	-	-	M3,5X11	T15
SVJBR 003 ISO	✓	✓	16	16	20	100	25	0	0	VBM. 1103..	-	-	M2,5X7	T08
SVJBR 004 ISO	✓	✓	20	20	25	125	35	0	0	VBM. 1604..	VB..016	M5X0.5XM3.5	M3,5X14	T15
SVJBR 005 ISO	✓	✓	20	20	25	125	35	0	0	VBM. 1103..	-	-	M2,5X7	T08
SVJBR 006 ISO	✓	✓	25	25	32	150	40	0	0	VBM. 1302..	-	-	M2,5X7	T08
SVJBR 007 ISO	✓	✓	32	32	40	170	40	0	0	VBM. 1103..	-	-	M2,5X7	T08
SVJBR 008 ISO	✓	✓	25	25	32	150	40	0	0	VBM. 1103..	-	-	M2,5X7	T08
SVJBR 010 ISO	X	X	25	25	32	150	40	0	0	VBM. 1103..	-	-	M2,5X7	T08
SVJBR 011 ISO	✓	X	12	12	20	125	20	0	0	VBM. 1103..	-	-	M2,5X7	T08

SVVBN ISO

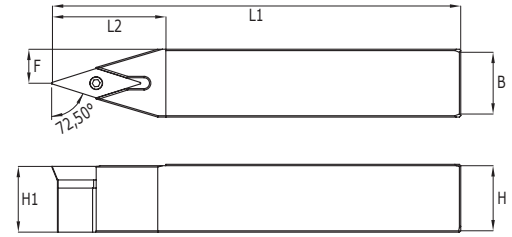

Kesici Uç Uyumluluğu Insert Suitability	Stok / Stock		Takım Ölçüleri / Dimension (mm)							Uç Insert	Altık Shim	Vida Screw	Vida Screw	Anahtar Torx Key
	R	L	H1	H	B	F	L1	L2	λS					
ISO														
SVVBN 001 ISO	✓		12	12	6	100	20	0	0	VBM. 1103..	-	-	M2,5X7	T08
SVVBN 002 ISO	✓		16	16	8	100	25	0	0	VBM. 1604..	-	-	M3,5X11	T15
SVVBN 003 ISO	✓		20	20	10	125	35	0	0	VBM. 1103..	-	-	M2,5X7	T08
SVVBN 004 ISO	✓		16	16	8	100	25	0	0	VBM. 1604..	VB..016	M5X0.5XM3.5	M3,5X14	T15
SVVBN 006 ISO	✓		20	20	10	125	35	0	0	VBM. 1103..	-	-	M2,5X7	T08
SVVBN 007 ISO	✓		25	25	12,5	150	40	0	0	VBM. 1604..	VB..016	M5X0.5XM3.5	M3,5X14	T15
SVVBN 008 ISO	✓		32	32	16	170	40	0	0	VBM. 1103..	-	-	M2,5X7	T08

SVHBR ISO

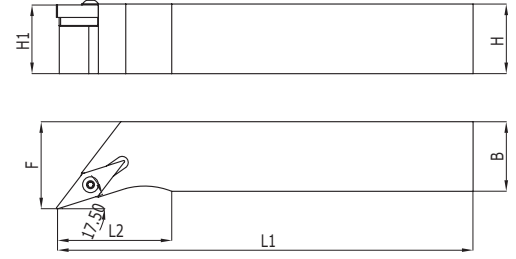

Kesici Uç Uyumluluğu Insert Suitability	Stok / Stock		Takım Ölçüleri / Dimension (mm)							Uç İnsert	Altlık Shim	Vida Screw	Vida Screw	Anahtar Torx Key
	R	L	H1	H	B	F	L1	L2	λS					
ISO														
SVHBR 000 ISO	✓	✓	12	12	20	100	20	0	0	VBM. 1103..	-	-	M2,5X7	T08
SVHBR 001 ISO	✓	✓	16	16	20	100	25	0	0		-	-		
SVHBR 002 ISO	✓	✓	16	16	20	100	25	0	0		-	-		
SVHBR 003 ISO	✓	✓	20	20	25	125	35	0	0	VBM. 1604..	VB..016	M5X0.5XM3.5	M3,5X14	T15
SVHBR 004 ISO	✓	✓	20	20	25	125	35	0	0					
SVHBR 005 ISO	✓	✓	25	25	32	150	40	0	0					

SVJCR ISO

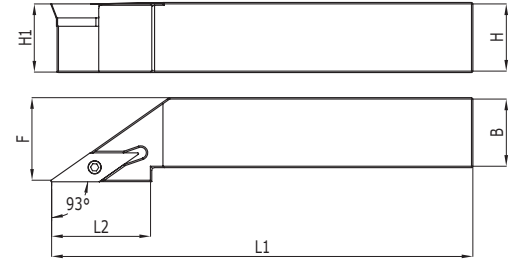

Kesici Uç Uyumluluğu Insert Suitability	Stok / Stock		Takım Ölçüleri / Dimension (mm)							Uç İnsert	Altlık Shim	Vida Screw	Vida Screw	Anahtar Torx Key
	R	L	H1	H	B	F	L1	L2	λS					
ISO														
SVJCR 001 ISO	✓	✓	12	12	20	100	20	0	0	VC.T 1103..	-	-	M2,5X7	T08
SVJCR 002 ISO	✓	✓	16	16	20	100	25	0	0		-	-		
SVJCR 003 ISO	✓	✓	16	16	20	100	25	0	0	VC.T 1604..	-	-	M3,5X11	T15
SVJCR 004 ISO	✓	✓	20	20	25	125	35	0	0	VC.T 1103..	-	-	M2,5X7	T08
SVJCR 005 ISO	✓	✓	20	20	25	125	35	0	0	VC.T 1604..	VC..016	M5X0.5XM3.5	M3,5X14	T15
SVJCR 006 ISO	✓	✓	25	25	32	150	40	0	0					
SVJCR 007 ISO	✓	✓	32	32	40	170	40	0	0					

SVVCN ISO

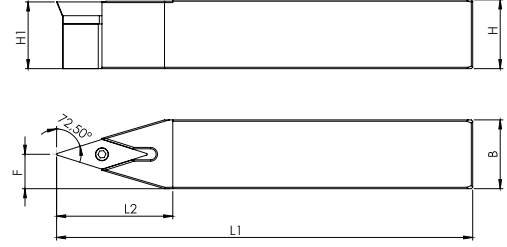

Kesici Uç Uyumluluğu Insert Suitability	Stok / Stock	Takım Ölçüleri / Dimension (mm)							Uç Insert	Altlık Shim	Vida Screw	Vida Screw	Anahtar Torx Key
		H1 H	B	F	L1	L2	λS	Y0					
ISO													
SVVCN 001 ISO	✓	12	12	6	100	20	0	0	VC.T 1103..	-	-	M2,5X7	T08
SVVCN 002 ISO	✓	16	16	8	100	25	0	0		-	-		
SVVCN 003 ISO	✓	20	20	10	125	35	0	0		-	-		
SVVCN 004 ISO	✓	16	16	8	100	25	0	0		-	-		
SVVCN 005 ISO	✓	20	20	10	125	35	0	0	VC.T 1604..	VB..016	M5X0.5XM3.5	M3,5X14	T15
SVVCN 006 ISO	✓	25	25	12,5	150	40	0	0					
SVVCN 007 ISO	✓	32	32	16	170	40	0	0					

SDNCN ISO



Kesici Uç Uyumluluğu Insert Suitability	Stok / Stock	Takım Ölçüleri / Dimension (mm)							Uç Insert	Altlık Shim	Vida Screw	Vida Screw	Anahtar Torx Key
		H1 H	B	F	L1	L2	λS	Y0					
ISO													
SDNCN 001 ISO	✓	8	8	4	100	16	0	0	DC.T 0702..	-	-	M2,5X7	T08
SDNCN 002 ISO	✓	10	10	5	100	16	0	0		-	-		
SDNCN 003 ISO	✓	12	12	6	100	20	0	0		-	-		
SDNCN 004 ISO	✓	16	16	8	100	25	0	0		-	-		
SDNCN 005 ISO	✓	16	16	8	100	25	0	0	DC.T 11T3..	-	-	M3,5X11	T15
SDNCN 006 ISO	✓	20	20	10	125	35	0	0	DC.T 11T3..	DC..011	M5X0.5XM3.5	M3,5X14	T15
SDNCN 007 ISO	✓	25	25	12,5	150	40	0	0					
SDNCN 008 ISO	✓	32	32	16	170	40	0	0					
SDNCN 009 ISO	✓	12	12	6	100	20	0	0					

SDJCR ISO

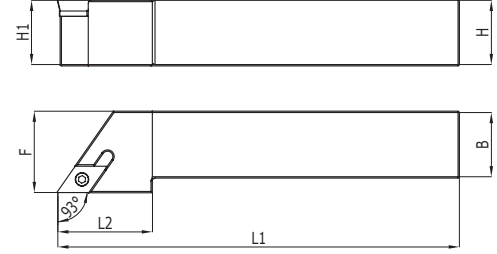

Kesici Uç Uyumluluğu Insert Suitability	Stok / Stock		Takım Ölçüleri / Dimension (mm)							Uç Insert	Altlık Shim	Vida Screw	Vida Screw	Anahtar Torx Key
	R	L	H1 H	B	F	L1	L2	λS	Y0					
ISO														
SDJCR 001 ISO	✓	✓	8	8	10	100	16	0	0	DC.T 0702..	-	-	M2,5X7	T08
SDJCR 002 ISO	✓	✓	10	10	12	100	16	0	0		-	-		
SDJCR 003 ISO	✓	✓	12	12	16	100	20	0	0		-	-		
SDJCR 004 ISO	✓	✓	16	16	20	100	25	0	0		-	-		
SDJCR 005 ISO	✓	✓	16	16	20	100	25	0	0	DC.T 11T3..	DC..011	M5X0.5XM3.5	M3,5X14	T15
SDJCR 006 ISO	✓	✓	20	20	25	125	35	0	0					
SDJCR 007 ISO	✓	✓	25	25	32	150	40	0	0					
SDJCR 008 ISO	✓	✓	32	32	40	170	40	0	0					

SCLCR ISO

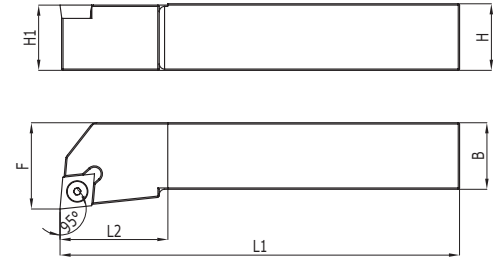

Kesici Uç Uyumluluğu Insert Suitability	Stok / Stock		Takım Ölçüleri / Dimension (mm)							Uç Insert	Altlık Shim	Vida Screw	Vida Screw	Anahtar Torx Key
	R	L	H1 H	B	F	L1	L2	λS	Y0					
ISO														
SCLCR 001 ISO	✓	✓	8	8	10	100	20	-10	0	CC.T 0602..	-	-	M2,5X5	T8
SCLCR 002 ISO	✓	✓	10	10	12	100	20	-10	0					
SCLCR 003 ISO	✓	✓	12	12	15	100	20	-10	0					
SCLCR 004 ISO	✓	✓	16	16	20	100	25	-8	0					
SCLCR 005 ISO	✓	✓	16	16	20	100	25	-8	0	CC.T 09T3..	-	-	M3,5X8	T15
SCLCR 006 ISO	✓	✓	20	20	25	125	35	-8	0					
SCLCR 007 ISO	✓	✓	25	25	32	150	35	-8	0					
SCLCR 008 ISO	✓	✓	16	16	20	100	25	-8	0					
SCLCR 009 ISO	✓	✓	20	20	25	125	35	-8	0	CC.T 1204..	CC..12	M6X0,75X11X4	M4X16 WLTR	T15
SCLCR 010 ISO	✓	✓	25	25	32	150	35	-8	0					
SCLCR 011 ISO	✓	✓	32	32	40	170	40	-8	0					
SCLCR 012 ISO	✓	✓	12	12	15	100	20	-8	0	CC.T 09T3..			M3,5X8	

SCNCN ISO

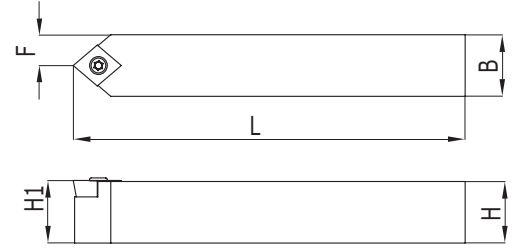

Kesici Uç Uyumluluğu Insert Suitability	Stok / Stock	Takım Ölçüleri / Dimension (mm)								Uç Insert	Altılık Shim	Vida Screw	Vida Screw	Anahtar Torx Key
		H1	H	B	F	L1	L2	λS	Y0					
ISO														
SCNCN 001 ISO	✓	8	8	4	100	16	0	0	CC.T 0602..	-	-	M2,5X7	T08	
SCNCN 002 ISO	✓	10	10	5	100	16	0	0						
SCNCN 004 ISO	✓	16	16	8	100	25	0	0	CC.T 09T3..	-	-	M3,5X11	T15	
SCNCN 005 ISO	✓	20	20	10	125	35	0	0	CC.T 09T3..	-	-	M3,5X11	T15	
SCNCN 006 ISO	✓	25	25	12,5	150	40	0	0	CC.T 1204..	CC..012	M6XM4	M4X14	T15	
SCNCN 008 ISO	✓	12	12	6	100	20	0	0	CC.T 0602..	-	-	M2,5X7	T15	
SCNCN 009 ISO	✓	12	12	6	150	40	0	0	CC.T 09T3..	-	-	M3,5X11	T15	

SRGCR ISO

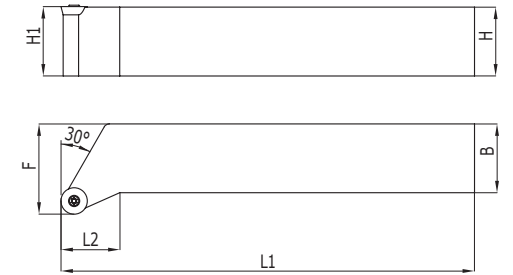

Kesici Uç Uyumluluğu Insert Suitability	Stok / Stock		Takım Ölçüleri / Dimension (mm)								Uç Insert	Vida Screw	Anahtar Torx Key
	R	L	H1	H	B	F	L1	L2	λS	Y0			
ISO													
SRGCR 001 ISO	✓	✓	16	16	21	125	25	0	0	RC.T 0803..	M3X9	T10	
SRGCR 002 ISO	✓	✓	20	20	25	125	35	0	0				
SRGCR 003 ISO	✓	✓	25	25	32	150	40	0	0				
SRGCR 004 ISO	✓	✓	16	16	21	100	25	0	0	RC.T 10T3..			
SRGCR 005 ISO	✓	✓	20	20	25	125	35	0	0				
SRGCR 006 ISO	✓	✓	25	25	32	150	40	0	0				
SRGCR 007 ISO	✓	✓	32	32	40	170	40	0	0				
SRGCR 008 ISO	✓	✓	16	16	21	100	25	0	0				
SRGCR 009 ISO	✓	✓	20	20	25	125	35	0	0				
SRGCR 010 ISO	✓	✓	25	25	32	150	40	0	0	RC.T 1204..	M4X11	T15	
SRGCR 011 ISO	✓	✓	32	32	40	170	40	0	0				

SRDCN ISO

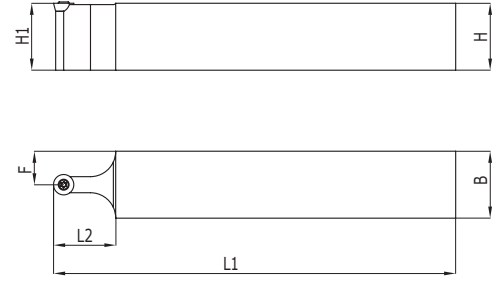

Kesici Uç Uyumluluğu Insert Suitability	Stok / Stock	Takım Ölçüleri / Dimension (mm)								Uç Insert	Vida Screw	Anahtar Torx Key
		ISO	H1 H	B	F	L1	L2	λS	Y0			
SRDCN 001 ISO	✓	16	16	8	125	25	0	0	RC.T 0803..	M3X9	T10	
SRDCN 002 ISO	✓	20	20	10	125	30	0	0				
SRDCN 003 ISO	✓	25	25	12,5	150	35	0	0				
SRDCN 004 ISO	✓	20	20	10	125	30	0	0	RC.T 10T3..	M4X11	T15	
SRDCN 005 ISO	✓	25	25	12,5	150	35	0	0				
SRDCN 006 ISO	✓	20	20	10	125	30	0	0	RC.T 1204..	M5X12	T20	
SRDCN 007 ISO	✓	25	25	12,5	150	35	0	0				
SRDCN 008 ISO	✓	25	25	12,5	150	35	0	0	RC.T 1604..	M4X11	T15	
SRDCN 009 ISO	✓	16	16	8	100	20	0	0				
SRDCN 010 ISO	✓	32	32	16	170	40	0	0	RC.T 10T3..	M4X11	T15	
SRDCN 011 ISO	✓	32	32	16	170	40	0	0				

SRHCR ISO

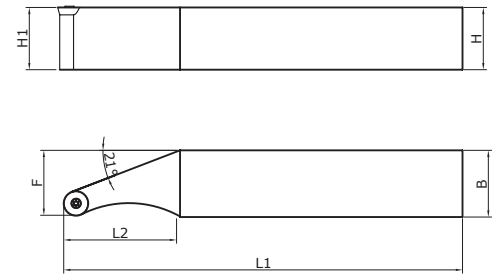

Kesici Uç Uyumluluğu Insert Suitability	Stok / Stock		Takım Ölçüleri / Dimension (mm)								Uç Insert	Vida Screw	Anahtar Torx Key
	R	L	ISO	H1 H	B	F	L1	L2	λS	Y0			
SRHCR 001 ISO	✓	X	16	16	16	125	25	0	0	RC.T 0803..	M3X9	T10	
SRHCR 002 ISO	✓	✓	20	20	20	125	35	0	0				
SRHCR 003 ISO	✓	✓	25	25	25	150	40	0	0				
SRHCR 004 ISO	✓	✓	20	20	20	125	35	0	0	RC.T 10T3..	M4X11	T15	
SRHCR 005 ISO	✓	✓	25	25	25	150	40	0	0				
SRHCR 006 ISO	✓	✓	20	20	20	125	35	0	0	RC.T 1204..	M5X12	T20	
SRHCR 007 ISO	✓	✓	25	25	25	150	40	0	0				
SRHCR 008 ISO	X	X	32	32	32	125	35	0	0	RC.T 1604..	M4X11	T15	
SRHCR 009 ISO	✓	X	16	16	16	125	35	0	0				

STFCR ISO

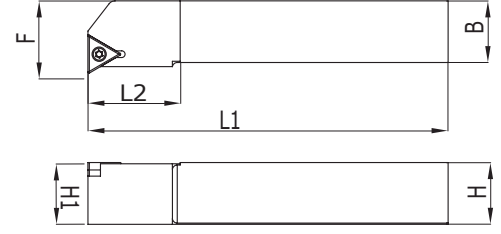

Kesici Uç Uyumluluğu Insert Suitability	Stok / Stock		Takım Ölçüleri / Dimension (mm)								Uç Insert	Altlık Shim	Vida Screw	Vida Screw	Anahtar Torx Key
	R	L	H1	H	B	F	L1	L2	λ S	Y0					
ISO															
STFCR 001 ISO	X	X	16	16	20	100	25	0	0	TC.T 16T3..	-	-	M3.5X11	T15	
STFCR 002 ISO	✓	✓	20	20	25	125	35	0	0		TC..016	M5XM3.5	M3.5X14		
STFCR 003 ISO	✓	✓	25	25	32	150	40	0	0						
STFCR 004 ISO	✓	✓	12	12	16	100	25	0	0	TC.T 11..	-	-	M2,5	T08	
STFCR 005 ISO	✓	✓	16	16	20	100	25	0	0		-	-	M2,5	T08	

STJCR ISO

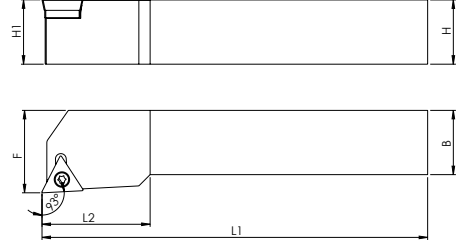

Kesici Uç Uyumluluğu Insert Suitability	Stok / Stock		Takım Ölçüleri / Dimension (mm)								Uç Insert	Altlık Shim	Vida Screw	Vida Screw	Anahtar Torx Key
	R	L	H1	H	B	F	L1	L2	λ S	Y0					
ISO															
STJCR 001 ISO	X	X	16	16	20	100	25	0	0	TC.T 16T3..	-	-	M3.5X11	T15	
STJCR 002 ISO	✓	✓	20	20	25	125	35	0	0		TC..016	M5XM3.5	M3.5X14		
STJCR 003 ISO	✓	✓	25	25	32	150	40	0	0						
STJCR 004 ISO	✓	✓	12	12	16	100	25	0	0	TC.T 11..	-	-	M2,5	T08	
STJCR 005 ISO	✓	✓	16	16	20	100	25	0	0		-	-	M2,5	T08	

DCMT 11 OTOMAT ISO

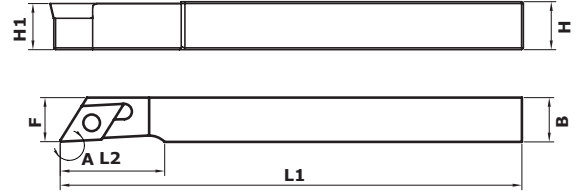

Kesici Uç Uyumluluğu Insert Suitability	Stok / Stock		Takım Ölçüleri / Dimension (mm)								Uç Insert	Vida Screw	Anahtar Torx Key	
	R	L	H1	H	B	F	L1	L2	A	λ S	Y0			
ISO														
OT SDACL 001 ISO	✓	✓	12	12	12	125	24	24	90°	0	DC.T 11TC..	M3,5X9	T15	
OT SDACR 001 ISO	✓	✓	12	12	12	125	24	24	90°	0				
OT SDJCL 001 ISO	✓	✓	12	12	12	125	24	24	90°	0				
OT SDJCR 001 ISO	✓	✓	12	12	12	125	24	24	90°	0				
OT SDNCN 001 ISO	✓	✓	12	12	12	125	24	24	90°	0				
OT SDJCL 002 ISO	✓	✓	16	16	12	125	24	24	90°	0				
OT SDJCR 002 ISO	✓	✓	16	16	12	125	24	24	90°	0				
OT STACR 001 ISO	✓	✓	12	12	12	125	24	24	90°	0				

Lütfen Sipariş vermeden önce stok durumunu sorunuz.
Please ask before ordering, stock status.

L: Sol / Left

R: Sağ / Right

✓ Stokta / In Stock

X Stokta Yok / Non Stock

SER ISO

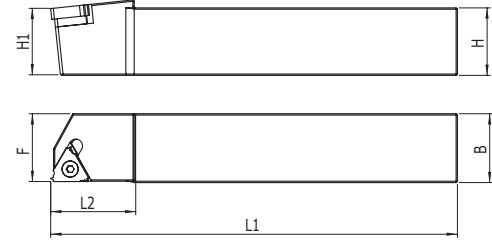

Kesici Uç Uyumluluğu Insert Suitability	Stok / Stock		Takım Ölçüleri / Dimension (mm)							Uç Insert	Altılık Shim	Vida Screw	Vida Screw	Anahtar Torx Key	Pabuç Clamp	Vida Screw	
	R	L	H1	H	B	F	L1	L2	λS	Y0							
ISO SER16																	
SER 003 ISO	✓	✓	12	12	12	100	20	-5,5	0	11 ER/L	-	-	M2,5X7	T08	-	-	
SER 004 ISO	✓	✓	12	12	12	100	20	-5,5	0	16 ER/L	ER/L..016	M5X0.5XM3.5	M3,5X14	T15	CK15	M3,5x9	
SER 005 ISO	✓	✓	16	16	16	100	30	-5,5	0	11 ER/L	-	-	M2,5X7	T08	-	-	
SER 006 ISO	✓	✓	16	16	16	125	30	-5,5	0	16 ER/L	ER/L..016	M5X0.5XM3.5	M3,5X14	T15	CK15	M4x12	
SER 007 ISO	✓	✓	20	20	20	125	35	-5,5	0								
SER 008 ISO	✓	✓	25	25	25	150	40	-5,5	0	22 ER/L	ER/L..022	-	M4X17	T15	-	-	
SER 009 ISO	✓	✓	25	25	25	150	40	-5,5	0	16 ER/L	ER/L..016	M5X0.5XM3.5	M3,5X14	T15	CK15	M4x12	
SER 010 ISO	✓	✓	32	32	32	170	40	-5,5	0	22 ER/L	ER/L..022	-	M4X15	T15	-	-	
SER 011 ISO	✓	✓	32	32	32	170	40	-5,5	0								

SER ZCC

NEW

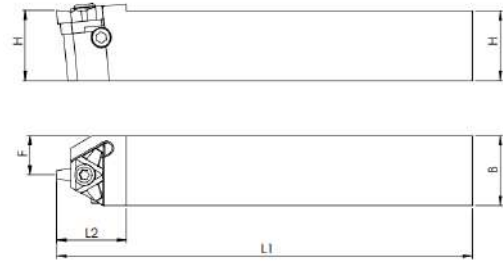

Kesici Uç Uyumluluğu Insert Suitability	Stok / Stock		Takım Ölçüleri / Dimension (mm)							Uç Insert	Vida Screw	Anahtar Torx Key	
	R	L	H1	H	B	F	L1	L2	λS	Y0			
ISO													
SER 014 ZCC	✓	✓	25	25	14	150	40	-5,5	0	22	4,5X17	T20	
SER 015 ZCC	✓	✓	25	25	16	150	40	-5,5	0	27	5X17		
SER 016 ZCC	✓	✓	32	32	22	170	40	-5,5	0	22	4,5X17		

SIR ISO

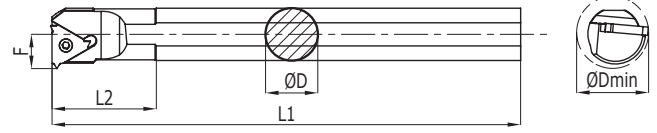

Kesici Uç Uyumluluğu Insert Suitability	Stok / Stock		Takım Ölçüleri / Dimension (mm)							Uç Insert	Altlık Shim	Vida Screw	Vida Screw	Anahtar Torx Key	Pabuç Clamp	Vida Screw	
	R	L	D	Dmin	F	L1	L2	λF	YP								
ISO SIR16																	
SIR 001 ISO	✓	✓	10	13	7,5	125	25	-15	-1,5	11 IR/ER	-	-	M2,5X6	T08	-	-	
SIR 002 ISO	✓	✓	12	15	8,5	150	25	-15	-1,5		-	-			-	-	
SIR 003 ISO	✓	✓	16	13	7,5	180	40	-15	-1,5		-	-			-	-	
SIR 004 ISO	✓	✓	16	20	11	180	30	-15	-1,5		-	-			-	-	
SIR 005 ISO	✓	✓	16	20	11	180	30	-15	-1,5	16 IR/ER	-	-	M3,5X8	T15	-	-	
SIR 006 ISO	✓	✓	20	25	13	200	35	-15	-1,5		-	-			-	-	
SIR 007 ISO	✓	✓	25	32	17	250	35	-15	-1,5		IR/ER 016	M5X0.5XM3.5			M3.5X11	-	-
SIR 008 ISO	✓	✓	32	40	21	300	40	-15	-1,5		-				M3.5X14	-	-
SIR 009 ISO	✓	✓	40	50	26	400	50	-15	-1,5	22 IR/ER	-	-	M4X12	T20	CK 15	M4x12	
SIR 010 ISO	✓	✓	25	32	17	250	35	-15	-1,5		-	-					
SIR 011 ISO	✓	✓	32	40	21	300	40	-15	-1,5		-	-					
SIR 012 ISO	✓	✓	40	50	26	400	50	-15	-1,5		-	-					
SIR 013 ISO	✓	✓	50	63	35	450	70	-15	-1,5	-	-	-	-	-	-		
SIR 014 ISO	✓	✓	60	73	40	450	70	-15	-1,5	-	-	-	-	-	-		
SIR 015 ISO	✓	✓	16	17	8	180	45	-15	-1,5	16 IR/ER	-	-	M3,5X8	T15	-	-	
SIR 016 ISO	✓	✓	20	25	13	200	35	-15	-1,5	22 IR/ER	IR/ER 022	-	M4X12	T20	CK 15	M4x12	
SIR 017 ISO	✓	✓	20	13	7,5	200	35	-15	-1,5	16 IR/ER	-	-	M3,5X8	T15	-	-	

SIR ZCC

NEW

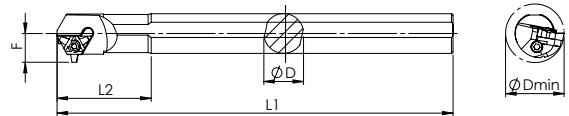

Kesici Uç Uyumluluğu Insert Suitability	Stok / Stock		Takım Ölçüleri / Dimension (mm)							Uç Insert	Altlık Shim	Vida Screw	Anahtar Torx Key	
	R	L	D	Dmin	F	L1	L2	λF	YP					
ZCC SIR														
SIR 014 ZCC	✓	X	25	33	19	250	60	-12	-3	22 IR/ER	-	M4,5X12	T20	
SIR 015 ZCC	✓	X	32	38	22	300	60	-10	-3		-			-
SIR 016 ZCC	✓	X	40	45	26	400	60	-12	-3		-			-
SIR 017 ZCC	✓	X	32	40	23	300	60	-14	-3	27 IR/ER	-	M5X17	T20	
SIR 018 ZCC	✓	X	40	50	26	400	60	-12	-3		-			-



C-SİSTEM DIŞ ÇAP TORNALAMA KATERLERİ

C-SYSTEM EXTERNAL TURNING TOOLHOLDERS

C-SİSTEM DIŞ ÇAP TORNALAMA KATERLERİ

C-SYSTEM EXTERNAL TURNING TOOLHOLDERS

MBC
Cutting Tools

CTGPR ISO

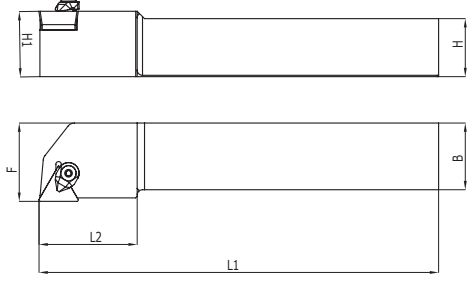

Kesici Uç Uyumluluğu Insert Suitability	Stok / Stock		Takım Ölçüleri / Dimension (mm)							Uç Insert	Altlık Shim	Vida Screw	Pabuç Clamp	Vida Screw	Anahtar Allen Key
	R	L	H1	H	B	F	L1	L2	λS	Y0					
CTGPR 001 ISO	✓	X	16	16	16	100	30	-6	-6	TP.1103	-	-	TP11	M5X12	A3
CTGPR 002 ISO	✓	X	16	16	20	100	30	-6	-6	TP.1603	-	-	-		
CTGPR 003 ISO	✓	X	20	20	25	125	35	-6	-6		TP16	M5X12	TP16		
CTGPR 004 ISO	✓	X	25	25	32	150	40	-6	-6		-	-	TP22		
CTGPR 005 ISO	✓	X	25	25	32	150	40	-6	-6	TP.2204	-	-	TP22		

CKJNR ISO

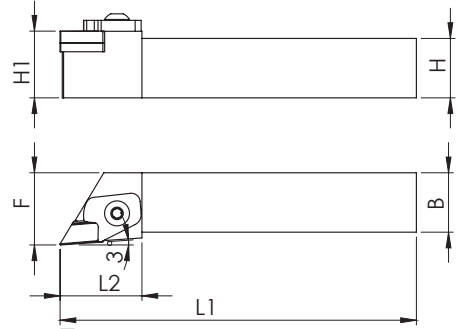

Kesici Uç Uyumluluğu Insert Suitability	Stok / Stock		Takım Ölçüleri / Dimension (mm)							Uç Insert	Altlık Shim	Vida Screw	Pabuç Clamp	Vida Screw	Anahtar Allen Key
	R	L	H1	H	B	F	L1	L2	λS	Y0					
CKJNR 004 ISO	✓	✓	20	20	25	125	35	-6	-6	KNUX 1604..	KN..016	M3X10	C160105	M6X22	A5
CKJNR 006 ISO	✓	✓	25	25	32	150	40	-6	-6						
CKJNR 007 ISO	✓	✓	32	32	40	170	40	-6	-6						
CKJNR 008 ISO	✓	✓	40	40	50	200	45	-6	-6						

Lütfen Sipariş vermeden önce stok durumunu sorunuz.
Please ask before ordering, stock status.

L: Sol / Left

R: Sağ / Right

✓ Stokta / In Stock

X Stokta Yok / Non Stock

TDJNR ISO

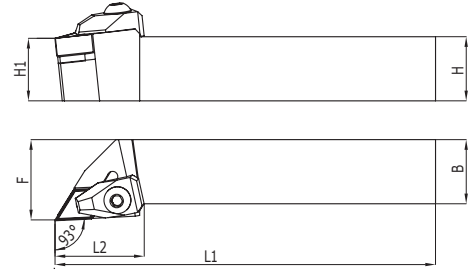

Kesici Uç Uyumluluğu Insert Suitability	Stok / Stock		Takım Ölçüleri / Dimension (mm)							Uç Insert	Altılık Shim	Vida Screw	Pabuç Clamp	Vida Screw	Anahtar Allen Key
	R	L	H1 H	B	F	L1	L2	λS	Y0						
ISO															
TDJNR 001 ISO	✓	✓	16	16	21	125	30	-6	-6	DNM. 1104..	DN..011	M4X11 T15	T110105	M5X23	A3
TDJNR 002 ISO	✓	✓	20	20	25	125	35	-6	-6						
TDJNR 003 ISO	✓	✓	25	25	32	150	40	-6	-6						
TDJNR 004 ISO	✓	✓	20	20	25	125	35	-6	-6	DNM. 1506..	DN..015	M4X10 A2,5	T150105	M6X27	
TDJNR 005 ISO	✓	✓	25	25	32	150	40	-6	-6						
TDJNR 006 ISO	✓	✓	32	32	40	170	40	-6	-6						
TDJNR 007 ISO	✓	✓	40	40	50	200	45	-6	-6						
TDJNR 008 ISO	✓	✓	16	16	21	125	30	-6	-6						

TDN NN ISO

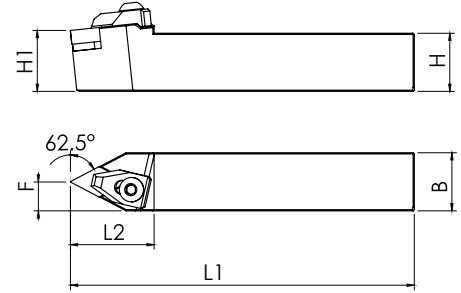

Kesici Uç Uyumluluğu Insert Suitability	Stok / Stock		Takım Ölçüleri / Dimension (mm)							Uç Insert	Altılık Shim	Vida Screw	Pabuç Clamp	Vida Screw	Anahtar Allen Key
	R	L	H1 H	B	F	L1	L2	λS	Y0						
ISO															
TDN NN 001 ISO	✓		16	16	8	125	30	-10	0	DNM. 1104..	DN..011	M4X11 T15	T110105	M5X23	A3
TDN NN 002 ISO	✓		20	20	10	125	35	-10	0						
TDN NN 003 ISO	✓		25	25	12,5	150	40	-10	0						
TDN NN 004 ISO	✓		20	20	10	125	35	-10	0	DNM. 1506..	DN..015	M4X10 A2,5	T150105	M6X27	
TDN NN 005 ISO	✓		25	25	12,5	150	40	-10	0						
TDN NN 006 ISO	✓		32	32	16	170	40	-10	0						
TDN NN 007 ISO	✓		40	40	20	200	45	-10	0						

TTGNR ISO

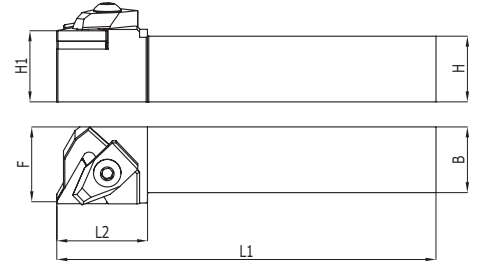

Kesici Uç Uyumluluğu Insert Suitability	Stok / Stock		Takım Ölçüleri / Dimension (mm)							Uç Insert	Altlık Shim	Vida Screw	Pabuç Clamp	Vida Screw	Anahtar Allen Key
	R	L	H1	H	B	F	L1	L2	λS	Y0					
TTGNR 001 ISO	✓	✓	20	20	25	125	35	-6	-6	TNMG 1604	TN..016(H)		T160105	M5X23	A3
TTGNR 002 ISO	✓	✓	25	25	32	150	40	-6	-6	TNMG 2204	TN..022(H)	M4X10 A2,5	T220105	M6X27	
TTGNR 003 ISO	✓	✓	20	20	25	125	40	-6	-6						
TTGNR 004 ISO	✓	✓	25	25	32	150	40	-6	-6						
TTGNR 005 ISO	✓	✓	32	32	40	170	40	-6	-6						
TTGNR 006 ISO	✓	✓	40	40	50	200	45	-6	-6						

TTJNR ISO

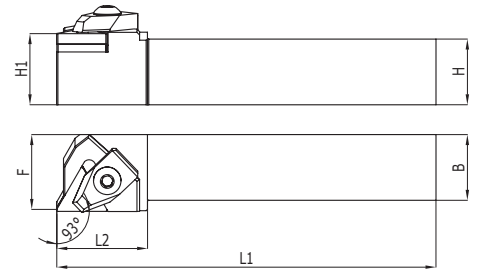

Kesici Uç Uyumluluğu Insert Suitability	Stok / Stock		Takım Ölçüleri / Dimension (mm)							Uç Insert	Altlık Shim	Vida Screw	Pabuç Clamp	Vida Screw	Anahtar Allen Key
	R	L	H1	H	B	F	L1	L2	λS	Y0					
TTJNR 001 ISO	✓	✓	16	16	21	125	30	-6	-6	TNMG 1604	TN..016(H)		T110105	M5X23	A3
TTJNR 002 ISO	✓	✓	20	20	25	125	35	-6	-6	TNMG 2204	TN..022(H)	M4X10 A2,5	T150105	M6X27	
TTJNR 003 ISO	✓	✓	25	25	32	150	40	-6	-6						
TTJNR 004 ISO	✓	✓	20	20	25	125	35	-6	-6						
TTJNR 005 ISO	✓	✓	25	25	32	150	40	-6	-6						
TTJNR 006 ISO	✓	✓	32	32	40	170	40	-6	-6						
TTJNR 007 ISO	✓	✓	40	40	50	200	45	-6	-6						

TSLNR ISO

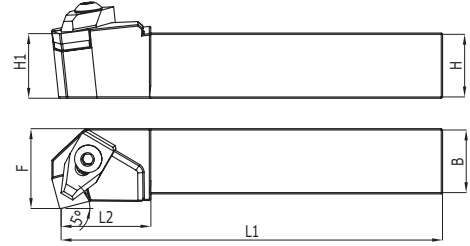

Kesici Uç Uyumluluğu Insert Suitability	Stok / Stock		Takım Ölçüleri / Dimension (mm)							Uç İnsert	Altlık Shim	Vida Screw	Pabuç Clamp	Vida Screw	Anahtar Allen Key	
	R	L	H1	H	B	F	L1	L2	λS	Y0						
ISO																
TSLNR 001 ISO	✓	✓	20	20	25	125	35	-6	-6	SNMG 1204	SN..012	M4X10 A2,5	T120105	M6X27	A3	
TSLNR 002 ISO	✓	✓	25	25	32	150	40	-6	-6							
TSLNR 003 ISO	✓	✓	32	32	40	170	40	-6	-6	SNMG 1906	SN..019	M5X10	T190105	M8X25	A5	
TSLNR 004 ISO	✓	✓	40	40	50	200	45	-6	-6				T160105	M6X27	A3	
TSLNR 005 ISO	✓	✓	32	32	40	170	40	-6	-6	SNMG 1506	SN..015	M5X10	T190105	M8X25	A5	
TSLNR 006 ISO	✓	✓	40	40	50	170	40	-6	-6							
TSLNR 007 ISO	✓	✓	32	32	40	170	40	-6	-6	SNMG 1906	SN..019	M5X10	T190105	M8X25	A5	

TSKNR ISO

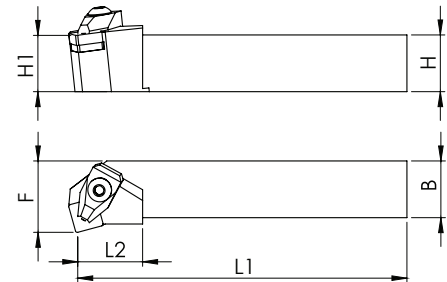

Kesici Uç Uyumluluğu Insert Suitability	Stok / Stock		Takım Ölçüleri / Dimension (mm)							Uç İnsert	Altlık Shim	Vida Screw	Pabuç Clamp	Vida Screw	Anahtar Allen Key	
	R	L	H1	H	B	F	L1	L2	λS	Y0						
ISO																
TSKNR 001 ISO	✓	✓	20	20	25	125	35	-6	-6	SNMG 1204	SN..012	M4X10 A2,5	T120105	M6X27	A3	
TSKNR 002 ISO	✓	✓	25	25	32	150	40	-6	-6					M6X27	A3	
TSKNR 005 ISO	✓	✓	32	32	40	170	40	-6	-6	SNMG 1506	SN..015	M5X10	T160105	M6X27	A3	
TSKNR 007 ISO	✓	✓	40	40	50	200	45	-6	-6	SNMG 1906	SN..019	M5X10	T190105	M8X25	A5	

TSRNR ISO

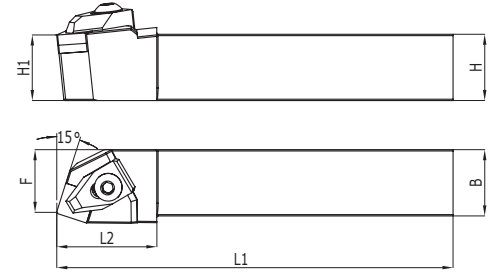

Kesici Uç Uyumluluğu Insert Suitability	Stok / Stock		Takım Ölçüleri / Dimension (mm)							Uç Insert	Altlık Shim	Vida Screw	Pabuç Clamp	Vida Screw	Anahtar Allen Key
	R	L	H1 H	B	F	L1	L2	λS	Y0						
ISO															
TSRNR 001 ISO	✓	✓	20	20	19	125	35	-6	-6	SNMG 1204	SN..012	M4X10 A2,5	T120105	M6X27	A3
TSRNR 002 ISO	✓	✓	25	25	24	150	40	-6	-6					M6X27	A3
TSRNR 003 ISO	✓	✓	32	32	30	170	40	-6	-6	SNMG 1506	SN..015	M5X10	T160105	M6X27	A3
TSRNR 004 ISO	✓	✓	40	40	38	200	45	-6	-6	SNMG 1906	SN..019		T190105	M8X25	A5
TSRNR 005 ISO	✓	✓	32	32	30	170	40	-6	-6	SNMG 1204	SN..012	M4X10 A2,5	T120105	M6X27	A3
TSRNR 006 ISO	✓	✓	32	32	30	170	40	-6	-6	SNMG 1906	SN..019	M5X10	T190105	M8X25	A5
TSRNR 007 ISO	✓	✓	40	40	38	200	45	-6	-6	SNMG 1506	SN..015		T160105	M6X27	A3

TSDNN ISO

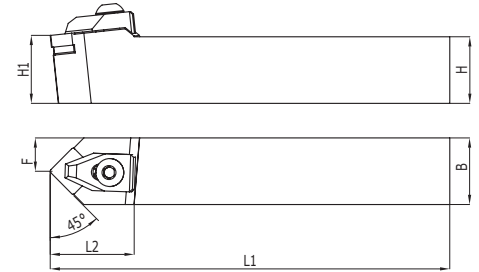

Kesici Uç Uyumluluğu Insert Suitability	Stok / Stock		Takım Ölçüleri / Dimension (mm)							Uç Insert	Altlık Shim	Vida Screw	Pabuç Clamp	Vida Screw	Anahtar Allen Key
	R	L	H1 H	B	F	L1	L2	λS	Y0						
ISO															
TSDNN 001 ISO	✓		20	20	10	125	35	-10	0	SNMG 1204	SN..012	M4X10 A2,5	T120105	M6X27	A3
TSDNN 002 ISO	✓		25	25	12,5	150	40	-10	0						
TSDNN 003 ISO	✓		32	32	16	170	40	-10	0	SNMG 1506	SN..015	M4X10 A2,5	T150105	M6X27	A3
TSDNN 004 ISO	✓		40	40	20	200	45	-10	0	SNMG 1906	SN..019	M5X10	T190105	M8X25	A5
TSDNN 005 ISO	✓		32	32	16	170	40	-10	0	SNMG 1204	SN..012	M4X10 A2,5	T120105	M6X27	A3
TSDNN 006 ISO	✓		32	32	16	170	40	-10	0	SNMG 1906	SN..019	M5X10	T190105	M8X25	A5
TSDNN 007 ISO	✓		40	40	20	200	45	-10	0	SNMG 1506	SN..015	M4X10 A2,5	T150105	M6X27	A3

TSSNR ISO

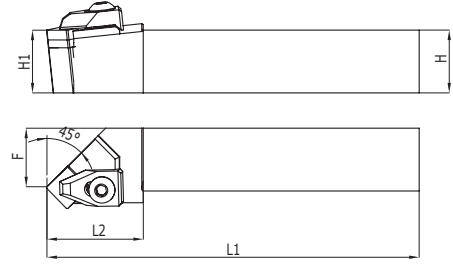

Kesici Uç Uyumluluğu Insert Suitability	Stok / Stock		Takım Ölçüleri / Dimension (mm)							Uç İnsert	Altlık Shim	Vida Screw	Pabuç Clamp	Vida Screw	Anahtar Allen Key
	ISO	R	L	H1	H	B	F	L1	L2						
TSSNR 001 ISO	✓	✓	20	20	19	125	35	-6	-6	SNMG 1204	SN..012	M4X10 A2,5	T120105	M6X27	A3
TSSNR 002 ISO	✓	✓	25	25	24	150	40	-6	-6	SNMG 1506	SN..015	M5X10	T160105		
TSSNR 003 ISO	✓	✓	32	32	30	170	40	-6	-6		SNMG 1906	SN..019	M5X10	T150105	M8X25
TSSNR 004 ISO	✓	✓	40	40	38	200	45	-6	-6	SNMG 1204	SN..012	M4X10 A2,5	T120105	M6X27	A3
TSSNR 005 ISO	✓	✓	32	32	30	170	40	-6	-6	SNMG 1906	SN..019	M5X10	T150105	M8X25	A5

TWLNR ISO

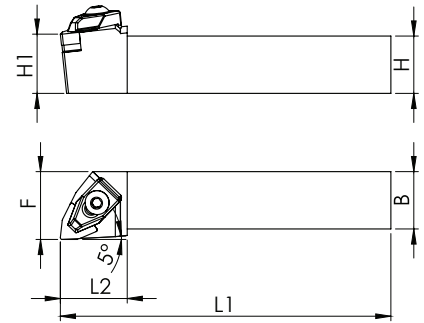

Kesici Uç Uyumluluğu Insert Suitability	Stok / Stock		Takım Ölçüleri / Dimension (mm)							Uç İnsert	Altlık Shim	Vida Screw	Pabuç Clamp	Vida Screw	Anahtar Allen Key
	ISO	R	L	H1	H	B	F	L1	L2						
TWLNR 001 ISO	✓	✓	16	16	21	125	30	-6	-6	WNM.0602..	-	-	T060105	M5X15	A3
TWLNR 002 ISO	✓	✓	20	20	25	125	35	-6	-6						
TWLNR 003 ISO	✓	✓	25	25	32	150	40	-6	-6	WNM.0804..	WN..08(H)	M4X10 A2,5	T080105	M6X27	A3
TWLNR 004 ISO	✓	✓	20	20	25	125	35	-6	-6						
TWLNR 005 ISO	✓	✓	25	25	32	150	40	-6	-6	WNM.10	-	-	T100105	M6X27	A3
TWLNR 006 ISO	✓	✓	32	32	40	170	40	-6	-6						
TWLNR 007 ISO	✓	✓	40	40	50	200	45	-6	-6	WNM.10	-	-	T100105	M6X27	A3
TWLNR 008 ISO	X	X	32	32	40	170	40	-6	-6						
TWLNR 009 ISO	X	X	40	40	50	200	45	-6	-6	WNM.10	-	-	T100105	M6X27	A3

TVJNR ISO

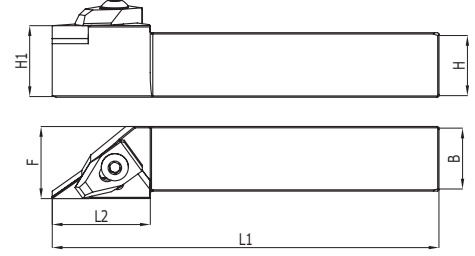

Kesici Uç Uyumluluğu Insert Suitability	Stok / Stock		Takım Ölçüleri / Dimension (mm)							Uç İnsert	Altık Shim	Vida Screw	Pabuç Clamp	Vida Screw	Anahtar Allen Key
	R	L	H1 H	B	F	L1	L2	λS	Y0						
ISO															
TVJNR 000 ISO	✓	✓	16	16	25	125	35	-6	-6	VNMG 1604	VN..016	M4X11 T15	T160105	M6X27	A3
TVJNR 001 ISO	✓	✓	20	20	25	125	35	-6	-6						
TVJNR 002 ISO	✓	✓	25	25	32	150	40	-6	-6						
TVJNR 003 ISO	✓	✓	32	32	40	170	40	-6	-6						
TVJNR 004 ISO	✓	✓	40	40	50	200	45	-6	-6						

TVNNN ISO

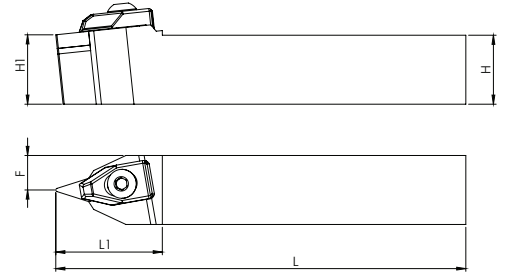

Kesici Uç Uyumluluğu Insert Suitability	Stok / Stock		Takım Ölçüleri / Dimension (mm)							Uç İnsert	Altık Shim	Vida Screw	Pabuç Clamp	Vida Screw	Anahtar Allen Key
	R	L	H1 H	B	F	L1	L2	λS	Y0						
ISO															
TVNNN 001 ISO	✓		20	20	10	125	30	-10	0	VNMG 1604	VN..016	M4X11 T15	T160105	M6X27	A3
TVNNN 002 ISO	✓		25	25	12,5	150	35	-10	0						
TVNNN 003 ISO	✓		32	32	16	170	40	-10	0						
TVNNN 004 ISO	✓		40	40	16	170	40	-10	0						

TCLNR ISO

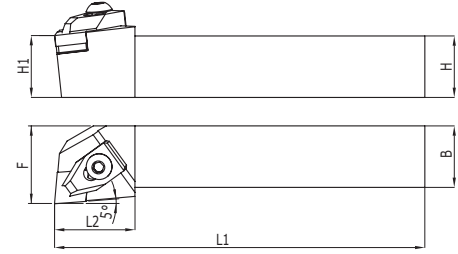

Kesici Uç Uyumluluğu Insert Suitability	Stok / Stock		Takım Ölçüleri / Dimension (mm)							Uç Insert	Altlık Shim	Vida Screw	Pabuç Clamp	Vida Screw	Anahtar Allen Key
	R	L	H1	H	B	F	L1	L2	λS						
ISO															
TCLNR 001 ISO	✓	✓	20	20	25	125	35	-6	-6	CNM. 1204..	CN..012	M4X10 A2,5	T120105	M6X27	A3
TCLNR 002 ISO	✓	✓	25	25	32	150	40	-6	-6						
TCLNR 003 ISO	✓	✓	32	32	40	170	40	-6	-6						
TCLNR 004 ISO	✓	✓	25	25	32	150	40	-6	-6	CNM. 1606..	CN..016	M5X10	T160105	M6X27	A3
TCLNR 005 ISO	✓	✓	32	32	40	170	40	-6	-6						
TCLNR 006 ISO	✓	✓	32	32	40	170	40	-6	-6						
TCLNR 007 ISO	✓	✓	40	40	50	200	45	-6	-6	CNM.1906..	CN..019	M5X10	T190105	M8X25	A5
TCLNR 008 ISO	✓	✓	40	40	50	200	45	-6	-6	CNM.1606..	CN..016	M5X10	T160105	M6X27	A3
TCLNR 009 ISO	✓	✓	16	16	25	100	35	-6	-6	CNM.1204..	CN..012	M4X10 A2,5	T120105	M6X27	A3

TCBNR ISO

NEW

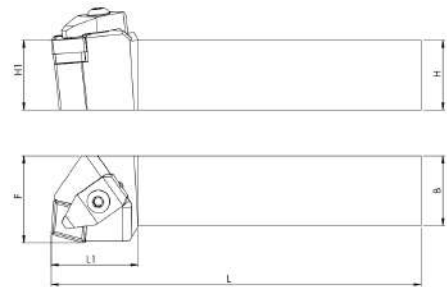

Kesici Uç Uyumluluğu Insert Suitability	Stok / Stock		Takım Ölçüleri / Dimension (mm)							Uç Insert	Altlık Shim	Vida Screw	Pabuç Clamp	Vida Screw	Anahtar Allen Key
	R	L	H1	H	B	F	L1	L2	λS						
ISO															
TCBNR 001 ISO	✓	✓	25	25	32	150	35	-6	-6	CNM. 1204..	CN..012	M4X10 A2,5	T120105	M6X27	A3
TCBNR 002 ISO	✓	✓	32	32	40	170	40	-6	-6	CNM. 1906..	CN..019	M5X10	T190105	M8X25	A5
TCBNR 003 ISO	✓	✓	40	40	50	200	40	-6	-6	CNM. 1906..					
TCBNR 004 ISO	✓	✓	20	20	25	125	35	-6	-6	CNM. 1204..	CN..012	M4X10 A2,5	T120105	M6X27	A3
TCBNR 005 ISO	✓	✓	32	32	40	170	40	-6	-6	CNM. 1204..					
TCBNR 006 ISO	✓	✓	32	32	40	170	40	-6	-6	CNM. 1606..	CN..016	M5X10	T160105	M6X27	A3

T-SİSTEM DIŞ ÇAP TORNALAMA KATERLERİ

T-SYSTEM EXTERNAL TURNING TOOLHOLDERS

MBC
Cutting Tools

TCKNR ISO

NEW

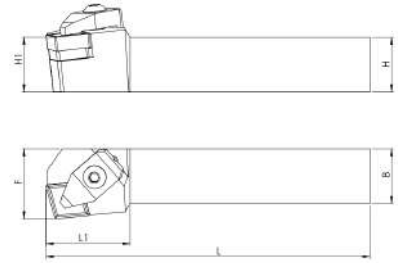

Kesici Uç Uyumluluğu Insert Suitability	Stok / Stock		Takım Ölçüleri / Dimension (mm)							Uç Insert	Altlık Shim	Vida Screw	Pabuç Clamp	Vida Screw	Anahtar Allen Key
	R	L	H1	H	B	F	L1	L2	λS						
TCKNR 001 ISO	✓	✓	25	25	32	150	35	-6	-6	CNM. 1204..	CN..012	M4X10 A2,5	T120105	M6X27	A3
TCKNR 002 ISO	✓	✓	25	25	32	150	35	-6	-6						
TCKNR 003 ISO	✓	✓	32	32	40	170	40	-6	-6						

TCZNN ISO

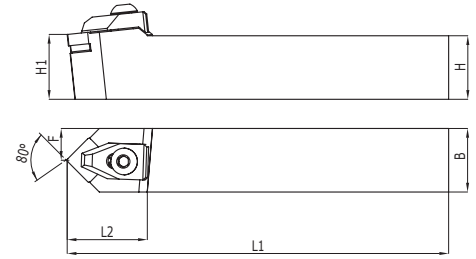

Kesici Uç Uyumluluğu Insert Suitability	Stok / Stock		Takım Ölçüleri / Dimension (mm)							Uç Insert	Altlık Shim	Vida Screw	Pabuç Clamp	Vida Screw	Anahtar Allen Key
	R	L	H1	H	B	F	L1	L2	λS						
TCZNN 001 ISO	✓		20	20	10	125	35	-10	0	CNM. 1204..	CN..012	M4X10 A2,5	T120105	M6X27	A3
TCZNN 002 ISO	✓		25	25	12,5	150	40	-10	0						
TCZNN 003 ISO	✓		32	32	16	170	40	-10	0						
TCZNN 004 ISO	✓		32	32	16	170	40	-10	0	CNM. 1906..	CN..019	M5X8 A2,5	T190105	M8X27	A5
TCZNN 005 ISO	✓		40	40	20	250	40	-10	0						
TCZNN 006 ISO	✓		32	32	16	170	40	-10	0	CNM. 1606..	CN..016	M5X10	T160105	M6X27	A3

TCMNN ISO

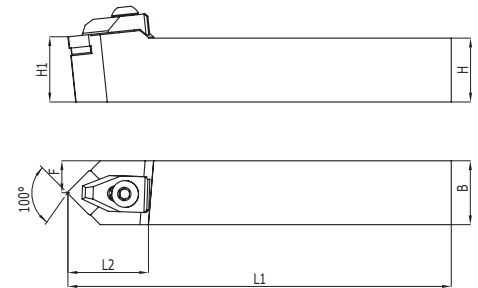

Kesici Uç Uyumluluğu Insert Suitability	Stok / Stock		Takım Ölçüleri / Dimension (mm)							Uç Insert	Altlık Shim	Vida Screw	Pabuç Clamp	Vida Screw	Anahtar Allen Key
	R	L	H1	H	B	F	L1	L2	λS						
TCMNN 001 ISO	✓		20	20	10	125	35	-10	0	CNM. 1204..	CN..012	M4X10 A2,5	T120105	M6X27	A3
TCMNN 002 ISO	✓		25	25	12,5	150	40	-10	0						
TCMNN 003 ISO	✓		32	32	16	170	40	-10	0						
TCMNN 004 ISO	✓		32	32	16	170	40	-10	0	CNM. 1906..	CN..019	M5X8 A2,5	T190105	M8X27	A5
TCMNN 005 ISO	✓		40	40	20	200	40	-10	0						
TCMNN 006 ISO	✓		32	32	40	170	40	-10	0	CNM. 1906..	CN..016	M5X10	T160105	M6X27	A3

Lütfen Sipariş vermeden önce stok durumunu sorunuz.
Please ask before ordering, stock status.

L: Sol / Left

R: Sağ / Right

✓ Stokta / In Stock

✗ Stokta Yok / Non Stock

MTJNR ISO

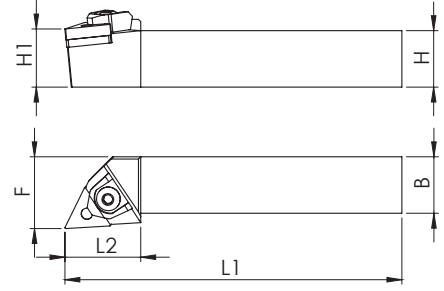

Kesici Uç Uyumluluğu Insert Suitability	Stok / Stock		Takım Ölçüleri / Dimension (mm)							Uç Insert	Altlık Shim	Vida Screw	Pabuç Clamp	Vida Screw	Anahtar Allen Key
	R	L	H1 H	B	F	L1	L2	λS	Y0						
ISO															
MTJNR 001 ISO	✓	✓	16	16	20	125	35	-6	-6	TNM.1604..	TN..016 (P)	5X3.6X15	M160105	M6X27	A3
MTJNR 002 ISO	✓	✓	20	20	25	125	35	-6	-6						
MTJNR 003 ISO	✓	✓	25	25	32	150	40	-6	-6						
MTJNR 004 ISO	✓	✓	32	32	40	170	40	-6	-6						
MTJNR 005 ISO	✓	✓	25	25	32	150	40	-6	-6	TNM.2204..	TN..022 (P)	6X5X15	M220105	M6X27	
MTJNR 006 ISO	✓	✓	32	32	40	170	40	-6	-6						
MTJNR 007 ISO	✓	✓	40	40	50	200	45	-6	-6						

MTENN ISO

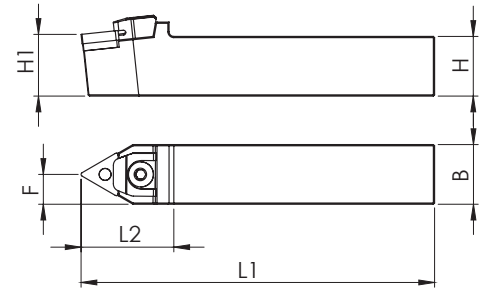

Kesici Uç Uyumluluğu Insert Suitability	Stok / Stock		Takım Ölçüleri / Dimension (mm)							Uç Insert	Altlık Shim	Vida Screw	Pabuç Clamp	Vida Screw	Anahtar Allen Key
	R	L	H1 H	B	F	L1	L2	λS	Y0						
ISO															
MTENN 001 ISO	✓		16	16	8	125	35	-10	0	TNM.1604..	TN..016 (P)	5X3.6X15	M160105	M5X23	A3
MTENN 002 ISO	✓		20	20	10	125	35	-10	0						
MTENN 003 ISO	✓		25	25	12,5	150	40	-10	0						
MTENN 004 ISO	✓		32	32	16	170	40	-10	0						
MTENN 005 ISO	✓		25	25	12,5	150	40	-10	0	TNM.2204..	TN..022 (P)	6X5X18	M220105	M6X27	
MTENN 006 ISO	✓		32	32	16	170	40	-10	0						
MTENN 007 ISO	✓		40	40	20	200	45	-10	0						

M-SİSTEM DIŞ ÇAP TORNALAMA KATERLERİ

M-SYSTEM EXTERNAL TURNING TOOLHOLDERS

MBC
Cutting Tools

MWLNR ISO

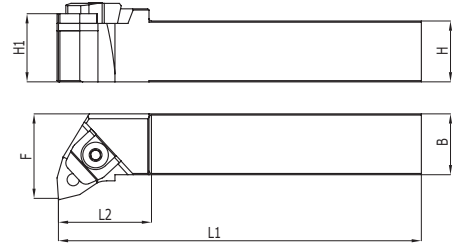

Kesici Uç Uyumluluğu Insert Suitability	Stok / Stock		Takım Ölçüleri / Dimension (mm)							Uç Insert	Altık Shim	Vida Screw	Pabuç Clamp	Vida Screw	Anahtar Allen Key
	R	L	H1	H	B	F	L1	L2	λS	Y0					
MWLNR 001 ISO	✓	✓	16	16	20	125	35	-6	-6	WNM.0604	-	5X3.6X15	M060105	M5X23	A3
MWLNR 002 ISO	✓	✓	20	20	25	125	35	-6	-6						
MWLNR 003 ISO	✓	✓	25	25	32	150	40	-6	-6						
MWLNR 004 ISO	✓	✓	20	20	25	125	35	-6	-6						
MWLNR 005 ISO	✓	✓	25	25	32	150	40	-6	-6	WNM.0804	WN.008(P)	6X5X8	M080105	M6X27	
MWLNR 006 ISO	✓	✓	32	32	40	170	40	-6	-6						
MWLNR 007 ISO	✓	✓	40	40	50	200	45	-6	-6						

MWDNN ISO

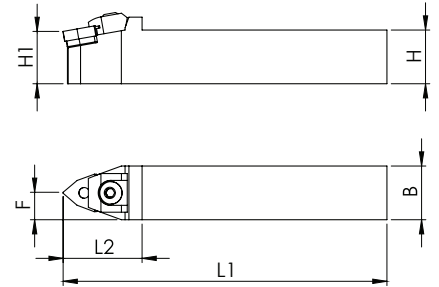

Kesici Uç Uyumluluğu Insert Suitability	Stok / Stock		Takım Ölçüleri / Dimension (mm)							Uç Insert	Altık Shim	Vida Screw	Pabuç Clamp	Vida Screw	Anahtar Allen Key
	R	L	H1	H	B	F	L1	L2	λS	Y0					
MWDNN 001 ISO	✓		16	16	8	125	35	-10	0	WNM.0604	-	5X3.6X15	M060105	M5X23	A3
MWDNN 002 ISO	✓		20	20	10	125	35	-10	0						
MWDNN 003 ISO	✓		20	20	10	125	40	-10	0						
MWDNN 004 ISO	✓		25	25	12,5	150	40	-10	0						
MWDNN 005 ISO	✓		32	32	16	170	40	-10	0	WNM.0804	WN.08(P)	6X5X18	M080105	M6X27	
MWDNN 006 ISO	✓		40	40	20	200	45	-10	0						

Lütfen Sipariş vermeden önce stok durumunu sorunuz.
Please ask before ordering, stock status.

L: Sol / Left

R: Sağ / Right

✓ Stokta / In Stock

✗ Stokta Yok / Non Stock

PCLNR ISO

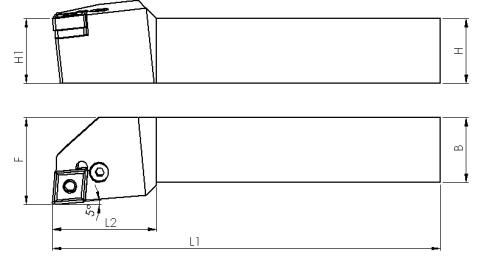

Kesici Uç Uyumluluğu Insert Suitability	Stok / Stock		Takım Ölçüleri / Dimension (mm)							Uç Insert	Altlık Shim	Vida Screw	Levyeye Crowbar	Altlık Sacı Metal Sheet	Anahtar Allen Key
	R	L	H1	H	B	F	L1	L2	λS						
ISO															
PCLNR 001 ISO	✓	✓	20	20	25	125	35	-6	-6	CNM. 1204..	CN..012	MPV M8 U	MPL 012	MPS 012	A3
PCLNR 002 ISO	✓	✓	25	25	32	150	40	-6	-6						
PCLNR 003 ISO	✓	✓	32	32	40	170	40	-6	-6						
PCLNR 004 ISO	✓	✓	40	40	50	200	45	-6	-6	CNM. 1604..	CN..016	MPL 016	MPS 016		
PCLNR 005 ISO	✓	✓	25	25	32	150	40	-6	-6						
PCLNR 006 ISO	✓	✓	32	32	40	170	40	-6	-6						
PCLNR 007 ISO	✓	✓	40	40	50	200	45	-6	-6	CNM. 1906..	CN..019	MPL 019	MPS 019		
PCLNR 008 ISO	✓	✓	32	32	40	170	40	-6	-6						
PCLNR 009 ISO	✓	✓	40	40	50	200	45	-6	-6						

PDJNR ISO

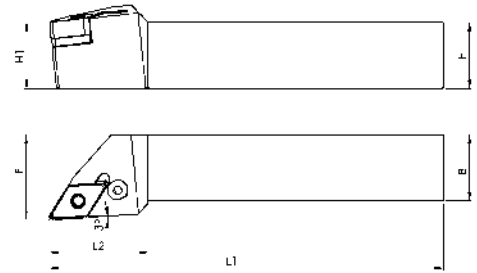

Kesici Uç Uyumluluğu Insert Suitability	Stok / Stock		Takım Ölçüleri / Dimension (mm)							Uç Insert	Altlık Shim	Vida Screw	Levyeye Crowbar	Altlık Sacı Metal Sheet	Anahtar Allen Key
	R	L	H1	H	B	F	L1	L2	λS						
ISO															
PDJNR 001 ISO	✓	✓	20	20	25	125	35	-6	-6	DNM. 1506..	DN..015	MPV M8 U	MPL 012	MPS 012	A3
PDJNR 002 ISO	✓	✓	25	25	32	150	40	-6	-6						
PDJNR 003 ISO	✓	✓	32	32	40	170	40	-6	-6						
PDJNR 004 ISO	✓	✓	40	40	45	200	45	-6	-6						

P-SİSTEM DIŞ ÇAP TORNALAMA KATERLERİ

P-SYSTEM EXTERNAL TURNING TOOLHOLDERS

MBC
Cutting Tools

PDNNN ISO

NEW

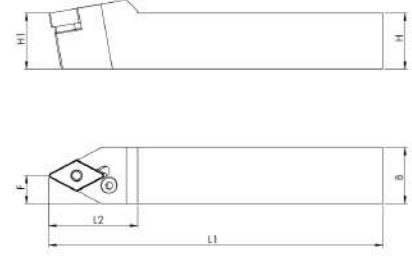

Kesici Uç Uyumluluğu Insert Suitability	Stok / Stock		Takım Ölçüleri / Dimension (mm)							Uç Insert	Altlık Shim	Vida Screw	Levye Crowbar	Altlık Sacı Metal Sheet	Anahtar Allen Key
	R	L	H1 H	B	F	L1	L2	λS	Y0						
ISO															
PDNNN 001 ISO	✓	✓	20	20	25	125	35	-6	0	DNM. 1506..	DN..015	MPV M8 U	MPL 012	MPS 012	A3
PDNNN 002 ISO	✓	✓	25	25	32	150	40	-6	0						
PDNNN 003 ISO	✓	✓	32	32	40	170	40	-6	0						
PDNNN 004 ISO	✓	✓	40	40	45	200	45	-6	0						

PWLNK ISO

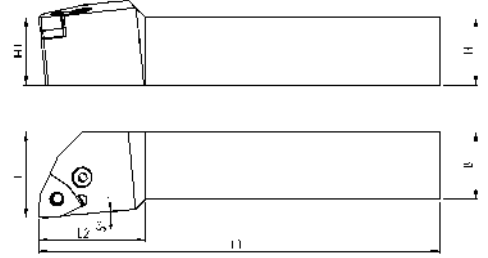

Kesici Uç Uyumluluğu Insert Suitability	Stok / Stock		Takım Ölçüleri / Dimension (mm)							Uç Insert	Altlık Shim	Vida Screw	Levye Crowbar	Altlık Sacı Metal Sheet	Anahtar Allen Key
	R	L	H1 H	B	F	L1	L2	λS	Y0						
ISO															
PWLNK 001 ISO	✓	✓	20	20	25	125	35	-6	-6	WNM0.0804..	WN..08 (H)	MPV M8 U	MPL 012	MPS 012	A3
PWLNK 002 ISO	✓	✓	25	25	32	150	40	-6	-6						
PWLNK 003 ISO	✓	✓	32	32	32	170	40	-6	-6						
PWLNK 004 ISO	✓	✓	40	40	25	200	45	-6	-6						

PTJNR ISO

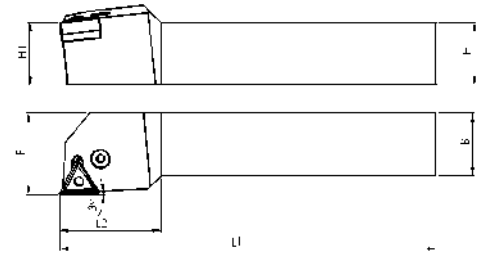

Kesici Uç Uyumluluğu Insert Suitability	Stok / Stock		Takım Ölçüleri / Dimension (mm)							Uç Insert	Altlık Shim	Vida Screw	Levye Crowbar	Altlık Sacı Metal Sheet	Anahtar Allen Key
	R	L	H1 H	B	F	L1	L2	λS	Y0						
ISO															
PTJNR 001 ISO	X	X	20	20	25	125	35	-6	-6	TNMG 1604	TN..16 (H)	MPV M8 U	MPL 011	MPS 011	A3
PTJNR 002 ISO	X	X	25	25	32	150	40	-6	-6						
PTJNR 003 ISO	X	X	32	32	40	170	40	-6	-6						
PTJNR 004 ISO	✓	✓	25	25	32	150	40	-6	-6	TNMG 2204	TN..022 (H)	MPL 012	MPS 012		
PTJNR 005 ISO	✓	✓	32	32	40	170	40	-6	-6						
PTJNR 006 ISO	X	X	40	40	50	200	45	-6	-6						

Lütfen Sipariş vermeden önce stok durumunu sorunuz.
Please ask before ordering, stock status.

L: Sol / Left

R: Sağ / Right

✓ Stokta / In Stock

X Stokta Yok / Non Stock



S-SİSTEM İÇ ÇAP TORNALAMA KATERLERİ

S-SYSTEM INTERNAL TURNING TOOLHOLDERS

S-SİSTEM İÇ ÇAP TORNALAMA KATERLERİ

S-SYSTEM INTERNAL TURNING TOOLHOLDERS

MBC
Cutting Tools

SVUBR ISO

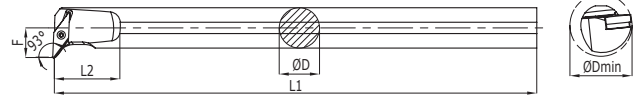

Kesici Uç Uyumluluğu Insert Suitability	Stok / Stock		Takım Ölçüleri / Dimension (mm)							Uç Insert	Altlık Shim	Vida Screw	Vida Screw	Anahtar Torx Key
	R	L	D	D min	F	L1	L2	λF	YP					
ISO														
SVUBR 001 ISO	✓	✓	16	20	11	180	40	-8	0	VBM. 1103..	-	-	M2,5X7	T08
SVUBR 002 ISO	✓	✓	20	25	13	200	40	-8	0					
SVUBR 003 ISO	✓	✓	25	32	17	250	50	-9	0	VBM. 1604..	VB..016	M5X0.5XM3.5	M3.5X11	T15
SVUBR 004 ISO	✓	✓	32	40	22	300	60	-9	0					
SVUBR 005 ISO	✓	✓	40	50	27	400	70	-9	0					

SVUCR ISO

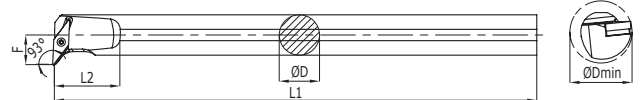

Kesici Uç Uyumluluğu Insert Suitability	Stok / Stock		Takım Ölçüleri / Dimension (mm)							Uç Insert	Altlık Shim	Vida Screw	Vida Screw	Anahtar Torx Key
	R	L	D	D min	F	L1	L2	λF	YP					
ISO														
SVUCR 001 ISO	✓	✓	16	20	11	180	40	-8	0	VCM. 1103..	-	-	M2,5X7	T08
SVUCR 002 ISO	✓	✓	20	25	13	200	40	-8	0					
SVUCR 003 ISO	✓	✓	25	32	17	250	50	-9	0	VCM. 1604..	VC..016	M5X0.5XM3.5	M3.5X11	T15
SVUCR 004 ISO	✓	✓	32	40	22	300	60	-9	0					
SVUCR 005 ISO	✓	✓	40	50	27	400	70	-9	0					

SVJBR ISO

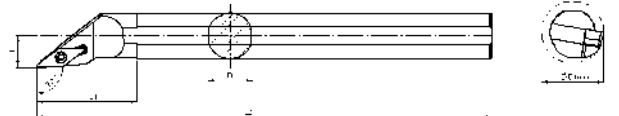

Kesici Uç Uyumluluğu Insert Suitability	Stok / Stock		Takım Ölçüleri / Dimension (mm)							Uç Insert	Altlık Shim	Vida Screw	Vida Screw	Anahtar Torx Key
	R	L	D	D min	F	L1	L2	λF	YP					
ISO														
SVJBR 001 ISO	✓	✓	25	32	17	250	50	-	-	VCM. 1604..	VC..016	M5X0.5XM3.5	M3.5X1	T15
SVJBR 002 ISO	✓	✓	32	40	23	300	80	-	-					
SVJBR 003 ISO	✓	✓	40	50	27	400	80	-	-					

Lütfen Sipariş vermeden önce stok durumunu sorunuz.
Please ask before ordering, stock status.

L: Sol / Left

R: Sağ / Right

✓ Stokta / In Stock

✗ Stokta Yok / Non Stock

SDPCR ISO

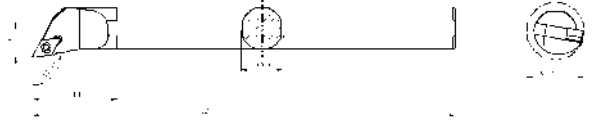

Kesici Uç Uyumluluğu Insert Suitability	Stok / Stock		Takım Ölçüleri / Dimension (mm)							Uç Insert	Aitlik Shim	Vida Screw	Vida Screw	Anahtar Torx Key
	R	L	D	D min	F	L1	L2	λF	YP					
ISO														
SDPCR 001 ISO	✓	X	10	13	7,5	125	25	-	-	DC.T 0702..			M2,5X5	T08
SDPCR 002 ISO	✓	X	12	16	9	150	30	-	-				DC.T 11T3..	
SDPCR 003 ISO	✓	X	16	20	11	180	35	-	-	M3.5X14	T15			
SDPCR 004 ISO	✓	X	20	25	13	200	40	-	-					
SDPCR 005 ISO	✓	X	25	32	17,5	250	50	-	-					
SDPCR 006 ISO	✓	X	32	40	23	300	60	-	-					

SDUCR ISO

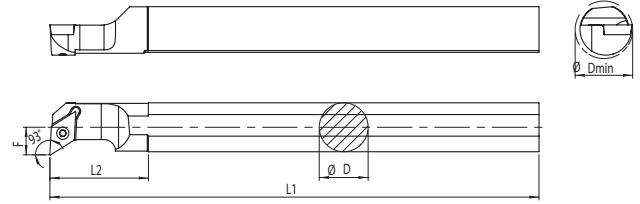

Kesici Uç Uyumluluğu Insert Suitability	Stok / Stock		Takım Ölçüleri / Dimension (mm)							Uç Insert	Aitlik Shim	Vida Screw	Vida Screw	Anahtar Torx Key
	R	L	D	D min	F	L1	L2	λF	YP					
ISO														
SDUCR 001 ISO	✓	✓	10	13	7,5	125	25	-11	0	DC.T 0702..			M2,5X5	T08
SDUCR 001 ISO (S)	✓	✓	10	13	7,5	125	25	-11	0				M2,5X7	
SDUCR 002 ISO	✓	✓	12	16	9	150	30	-9	0	DC.T 11T3..				M3.5X8
SDUCR 002 ISO(S)	✓	✓	12	16	9	150	30	-9	0				DC.T 0702..	
SDUCR 003 ISO	✓	✓	16	20	11	180	35	-9	0	DC.T 11T3..				
SDUCR 004 ISO	✓	✓	16	20	11	180	35	-9	0				DC.T 11T3..	
SDUCR 004 ISO (S)	✓	✓	16	20	11	180	35	-9	0	DC.T 0702..				
SDUCR 005 ISO	✓	✓	20	25	13	200	40	-8	0				DC.T 11T3..	
SDUCR 006 ISO	✓	✓	20	25	13	200	40	-8	0	DC.T 11T3..				
SDUCR 006 ISO (S)	✓	✓	20	25	13	200	40	-8	0				DC.T 11T3..	
SDUCR 007 ISO	✓	✓	25	32	17,5	250	50	-8	0	DC.T 11T3..				
SDUCR 007 ISO (S)	✓	✓	25	32	17,5	250	50	-8	0				DC.T 0702..	
SDUCR 008 ISO	✓	✓	25	32	17,5	250	50	-8	0	DC.T 11T3..				
SDUCR 009 ISO	✓	✓	32	40	23	300	60	-8	0				DC.T 11T3..	
SDUCR 010 ISO	✓	✓	40	50	27	400	60	-8	0	DC.T 0702..				
SDUCR 011 ISO	✓	✓	12	15	8	125	25	-9	0					

S-SİSTEM İÇ ÇAP TORNALAMA KATERLERİ

S-SYSTEM INTERNAL TURNING TOOLHOLDERS

MBC
Cutting Tools

SDQCR ISO

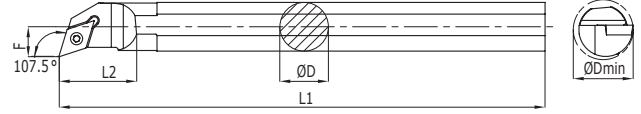

Kesici Uç Uyumluluğu Insert Suitability	Stok / Stock		Takım Ölçüleri / Dimension (mm)							Uç Insert	Altılık Shim	Vida Screw	Vida Screw	Anahtar Torx Key
	R	L	D	D min	F	L1	L2	λF	YP					
ISO														
SDQCR 001 ISO	✓	✓	10	13	7,5	125	25	-11	0	DC.T 0702..			M2,5X5	T08
SDQCR 001 ISO (S)	✓	✗	10	12	7,5	125	25	-11	0					
SDQCR 002 ISO	✓	✓	12	16	9	150	30	-9	0					
SDQCR 002 ISO (S)	✓	✗	12	16	9	150	30	-9	0					
SDQCR 003 ISO	✓	✓	16	20	11	180	35	-9	0	DC.T 11T3..			M2,5X7	T15
SDQCR 004 ISO	✓	✓	20	25	13	200	40	-8	0					
SDQCR 005 ISO	✓	✓	16	20	11	180	35	-9	0					
SDQCR 005 ISO (S)	✓	✗	16	20	11	180	35	-9	0					
SDQCR 006 ISO	✓	✓	20	25	13	200	40	-8	0	DC.T 0702..			M3,5X8	T08
SDQCR 006 ISO (S)	✓	✗	20	25	13	200	40	-8	0					
SDQCR 007 ISO	✓	✓	25	32	17,5	250	50	-8	0					
SDQCR 008 ISO	✓	✓	25	32	17,5	250	50	-8	0					
SDQCR 009 ISO	✓	✓	32	40	23	300	60	-8	0	DC.T 11T3..	DC..011	M5X0.5XM3.5	M3.5X14	T15

SD-CR ISO

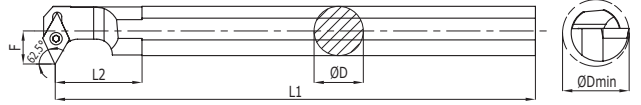

Kesici Uç Uyumluluğu Insert Suitability	Stok / Stock		Takım Ölçüleri / Dimension (mm)							Uç Insert	Altılık Shim	Vida Screw	Vida Screw	Anahtar Torx Key
	R	L	D	D min	F	L1	L2	λF	YP					
ISO														
SD-CR 001 ISO	✓	✓	10	14	8,5	125	28	-9	0	DC.T 0702..			M2,5X7	T08
SD-CR 002 ISO	✓	✓	12	16	9	150	30	-9	0					
SD-CR 003 ISO	✓	✓	16	23	14	180	40	-8	0					
SD-CR 004 ISO	✓	✓	16	23	14	180	40	-8	0					
SD-CR 005 ISO	✓	✓	20	25	14,5	200	45	-8	0	DC.T 11T3..			M3,5X8	T15
SD-CR 006 ISO	✓	✓	25	32	19	250	55	-8	0					
SD-CR 007 ISO	✓	✓	32	40	23	300	60	-12	0					
SD-CR 008 ISO	✓	✗	40	50	27	400	70	-10	0					
										DC..011	M5X0.5XM3.5	M3.5X14		

SDXCR ISO

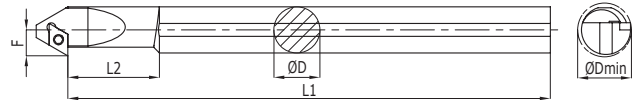

Kesici Uç Uyumluluğu Insert Suitability	Stok / Stock		Takım Ölçüleri / Dimension (mm)							Uç Insert	Altılık Shim	Vida Screw	Vida Screw	Anahtar Torx Key
	R	L	D	D min	F	L1	L2	λF	YP					
ISO														
SDXCR 001 ISO	✓	✓	12	16	9	150	30	-7	0	DC.T 0702..			M2,5X5	T08
SDXCR 002 ISO	✓	✓	16	22	12,5	180	40	-9	0					
SDXCR 003 ISO	✓	✓	16	22	12,5	180	40	-9	0					
SDXCR 004 ISO	✓	✓	20	25	14	200	55	-9	0					
SDXCR 005 ISO	✓	✓	25	32	17,5	250	65	-10	0	DC.T 11T3..			M3,5X8	T15
SDXCR 006 ISO	✓	✓	32	40	23	300	80	-13	0					
SDXCR 007 ISO	✓	✓	40	50	27	400	80	-13	0					
													DC..011	

Lütfen Sipariş vermeden önce stok durumunu sorunuz.
Please ask before ordering, stock status.

L: Sol / Left

R: Sağ / Right

✓ Stokta / In Stock

✗ Stokta Yok / Non Stock

SET SDUCR

NEW

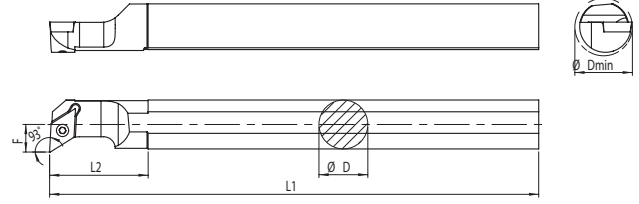

Kesici Uç Uyumluluğu Insert Suitability	Stok / Stock		Takım Ölçüleri / Dimension (mm)							Uç Insert	Altık Shim	Vida Screw	Vida Screw	Anahtar Torx Key
	R	L	H1 H	B	F	L1	L2	λS	Y0					
ISO	✓	✓	10	13	7,5	125	25	-11	0					
	✓	✓	12	16	9	150	30	-9	0	DC.T 0702..	-	-	M2,5X5	T08
	✓	✓	16	20	11	180	35	-9	0	DC.T 11T3..	-	-	M3,5X8	T15
SET 3 SDUCR ISO	✓	✓	10	13	7,5	125	25	-11	0	DC.T 0702..	-	-	M2,5X5	T08
	✓	✓	12	16	9	150	30	-9	0	DC.T 11T3..	DC..011	M5X0.5XM3.5	M3,5X8	T15
	✓	✓	16	20	11	180	35	-9	0					
	✓	✓	20	25	13	200	40	-8	0					

SET SCLCR

NEW

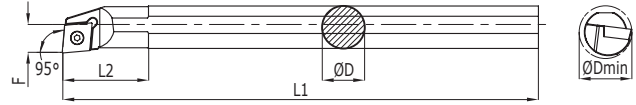

Kesici Uç Uyumluluğu Insert Suitability	Stok / Stock		Takım Ölçüleri / Dimension (mm)							Uç Insert	Altık Shim	Vida Screw	Vida Screw	Anahtar Torx Key
	R	L	D	D min	F	L1	L2	λF	YP					
ISO	✓	✓	8	10	6	100	30	-10	0					
	✓	✓	10	13	7	125	25	-10	0	CC.T 0602..	-	-	M2,5X5	T08
	✓	✓	12	16	9	150	30	-8	0	CC.T 09T3..	-	-	M3,5X11	T15
	✓	✓	16	20	11	180	35	-8	0					
SET 4 SCLCR ISO	✓	✓	8	10	6	100	30	-10	0	CC.T 0602..	-	-	M2,5X5	T08
	✓	✓	10	13	7	125	25	-10	0	CC.T 09T3..	-	-	M3,5X11	T15
	✓	✓	12	16	9	150	30	-8	0					
	✓	✓	16	20	11	180	35	-8	0					
SET 5 SCLCR ISO	✓	✓	6	9	4,5	100	30	-10	0	CC.T 0602..	-	-	M2,5X5	T08
	✓	✓	8	10	6	100	30	-10	0	CC.T 09T3..	-	-	M3,5X11	T15
	✓	✓	10	13	7	125	25	-10	0					
	✓	✓	12	16	9	150	30	-8	0					
SET 6 SCLCR ISO	✓	✓	16	20	11	180	35	-8	0	CC.T 0602..	-	-	M2,5X5	T08
	✓	✓	20	25	13	200	40	-8	0	CC.T 09T3..	-	-	M3,5X11	T15
	✓	✓	6	9	4,5	100	30	-10	0					
	✓	✓	8	10	6	100	30	-10	0					

S-SİSTEM İÇ ÇAP TORNALAMA KATERLERİ

S-SYSTEM INTERNAL TURNING TOOLHOLDERS

MBC
Cutting Tools

SCLCR ISO

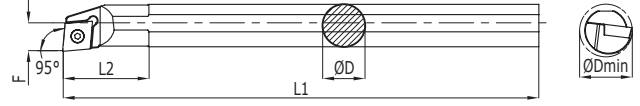

Kesici Uç Uyumluluğu Insert Suitability	Stok / Stock		Takım Ölçüleri / Dimension (mm)							Uç Insert	Altlık Shim	Vida Screw	Vida Screw	Anahtar Torx Key
	R	L	D	D min	F	L1	L2	ΛF	YP					
SCLCR/S 001 ISO	✓	✓	8	9	4,5	100	30	-10	0	CC.T 0602..			M2,5X5	T08
SCLCR/S 001 ISO (S)	✓	✓	8	9	4,5	100	30	-10	0					
SCLCR/S 002 ISO	✓	✓	8	11	6	100	25	-10	0					
SCLCR/S 002 ISO (S)	✓	✓	8	11	6	100	25	-10	0					
SCLCR/S 003 ISO	✓	✓	10	13	7	125	25	-10	0					
SCLCR/S 003 ISO (S)	✓	✓	10	13	7	125	25	-10	0					
SCLCR/S 004 ISO	✓	✓	12	16	9	150	30	-8	0	CC.T 09T3..			M3,5X8	T15
SCLCR/S 004 ISO (S)	✓	✓	12	16	9	150	30	-8	0					
SCLCR/S 005 ISO	✓	✓	12	16	9	150	30	-8	0	CC.T 09T3..			M3,5X8	T15
SCLCR/S 005 ISO (S)	✓	✓	12	16	9	150	30	-8	0	CC.T 0602..			M2,5X7	T08
SCLCR/S 006 ISO	✓	✓	16	20	11	180	35	-8	0	CC.T 09T3..			M3,5X8	T15
SCLCR/S 006 ISO (S)	✓	✓	16	20	11	180	35	-8	0					
SCLCR/S 007 ISO	✓	✗	16	20	11	180	35	-8	0					
SCLCR/S 007 ISO (S)	✓	✓	16	20	11	180	35	-8	0					
SCLCR/S 008 ISO	✓	✓	20	25	13	200	40	-8	0					
SCLCR/S 008 ISO (S)	✓	✗	20	25	13	200	40	-8	0					
SCLCR/S 009 ISO	✓	✓	25	32	17	250	50	-8	0	CC.T 1204..	CC..012	M6X0,75X11X4	M4X16 WLTR	T15
SCLCR/S 010 ISO	✓	✗	32	40	23	300	60	-8	0					
SCLCR/S 011 ISO	✓	✓	25	32	17	250	50	-8	0					
SCLCR/S 011 ISO (S)	✓	✗	25	32	17	250	50	-8	0	CC.T 0602..	-	-	M2,5X5	T08
SCLCR/S 012 ISO	✓	✓	32	40	23	300	60	-8	0	CC.T 09T3..	-	-	M3,5X6	T15
SCLCR/S 013 ISO	✓	✓	40	50	27	400	70	-8	0					
SCLCR/S 018 ISO	✓	✓	12	12,5	7	125	25	-10	0					
SCLCR/S 019 ISO	✓	✗	16	15,5	9	150	30	-8	0					
SCLCR/S 020 ISO	✓	✗	16	15,5	9	150	30	-8	0					

STFCR ISO

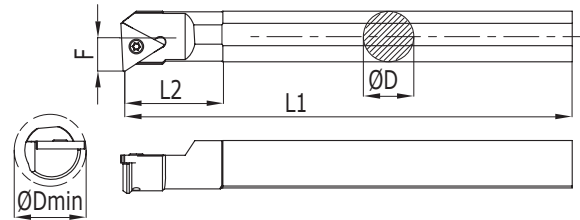

Kesici Uç Uyumluluğu Insert Suitability	Stok / Stock		Takım Ölçüleri / Dimension (mm)							Uç Insert	Altlık Shim	Vida Screw	Vida Screw	Anahtar Torx Key
	R	L	D	D min	F	L1	L2	ΛF	YP					
STFCR/S 001 ISO	✓	✓	16	20	11	180	35	-9	0	TC.T 16T3..			M3,5X8	T15
STFCR/S 002 ISO	✓	✓	20	25	13	200	40	-8	0					
STFCR/S 003 ISO	✓	✓	25	32	17,5	250	50	-8	0					
STFCR/S 004 ISO	✓	✓	32	40	23	300	60	-8	0					
STFCR/S 005 ISO	✓	✓	12	15,5	9	150	30	-9	0					
STFCR/S 005 ISO	✓	✓	12	15,5	9	150	30	-9	0	TC.T 11	-	-	M2,5X6	T08

Lütfen Sipariş vermeden önce stok durumunu sorunuz.
Please ask before ordering, stock status.

L: Sol / Left

R: Sağ / Right

✓ Stokta / In Stock

✗ Stokta Yok / Non Stock



C-SİSTEM İÇ ÇAP TORNALAMA KATERLERİ

C-SYSTEM INTERNAL TURNING TOOLHOLDERS

CKUNR ISO

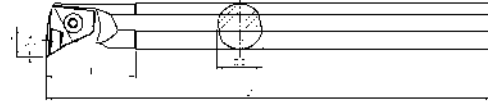

Kesici Uç Uyumluluğu Insert Suitability	Stok / Stock		Takım Ölçüleri / Dimension (mm)							Uç Insert	Altılık Shim	Vida Screw	Pabuç Clamp	Vida Screw	Anahtar Allen Key
	R	L	D	D min	F	L1	L2	λF	YP						
ISO															
CKUNR 002 ISO	✓	✓	25	32	17	250	50	-12	-5	KNUX 1604..	KN..016 (R/L)	M3X8 A2.5	C160105	M6X27	A3
CKUNR 003 ISO	✓	✓	32	40	22	300	60	-12	-5						
CKUNR 004 ISO	✓	✓	40	50	27	400	65	-9	-5						
CKUNR 005 ISO	✓	✓	50	63	35	450	70	-7	-5						
CKUNR 006 ISO	✓	X	60	75	35	450	70	-7	-5						

CTUPR ISO

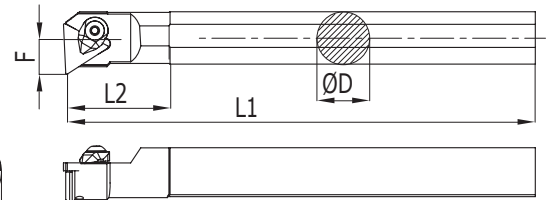

Kesici Uç Uyumluluğu Insert Suitability	Stok / Stock		Takım Ölçüleri / Dimension (mm)							Uç Insert	Altılık Shim	Vida Screw	Pabuç Clamp	Vida Screw	Anahtar Allen Key
	R	L	D	D min	F	L1	L2	λF	YP						
ISO															
CTUPR 001 ISO	✓	X	16	20	11	180	35	-8	-	TPKN 1603	-	-	C160105	M5X23	A3
CTUPR 002 ISO	✓	X	20	25	13	200	40	-8	-						
CTUPR 003 ISO	✓	X	25	32	17	250	50	-8	-						

TDUNR ISO

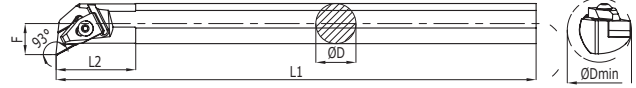

Kesici Uç Uyumluluğu Insert Suitability	Stok / Stock		Takım Ölçüleri / Dimension (mm)							Uç Insert	Altlık Shim	Vida Screw	Pabuç Clamp	Vida Screw	Anahtar Allen Key				
	R	L	D	D min	F	L1	L2	λF	YP										
ISO																			
TDUNR 001 ISO	✓	✓	20	25	13	200	40	-11	-5	DNM. 1104..	-	-	T110105	M5X15	A3				
TDUNR 002 ISO	✓	✓	25	32	17	250	50	-13	-5					M6X20					
TDUNR 003 ISO	✓	✓	32	40	22	300	60	-12	-5					DNM. 1506..		DN..15	M4X10 A2.5	T150105	M6X27
TDUNR 004 ISO	✓	✓	40	50	27	400	70	-12	-5										
TDUNR 005 ISO	✓	✓	50	63	35	450	75	-12	-5										
TDUNR 006 ISO	✓	✓	60	75	40	450	75	-12	-5										

TDQNR ISO

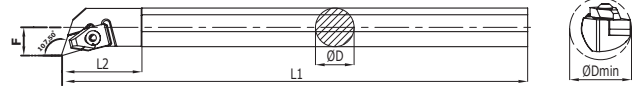

Kesici Uç Uyumluluğu Insert Suitability	Stok / Stock		Takım Ölçüleri / Dimension (mm)							Uç Insert	Altlık Shim	Vida Screw	Pabuç Clamp	Vida Screw	Anahtar Allen Key
	R	L	D	D min	F	L1	L2	λF	YP						
ISO															
TDQNR 000 ISO	✓	✓	25	32	17	250	50	-13	-5	DNM. 1506..	DN..015	M4X10 A2.5	T150105	M6X20	A3
TDQNR 001 ISO	✓	✓	32	40	22	300	60	-12	-5					M6X27	
TDQNR 002 ISO	✓	✓	40	50	27	400	70	-12	-5						
TDQNR 003 ISO	✓	✓	50	63	35	450	75	-12	-5						

TD-NR ISO

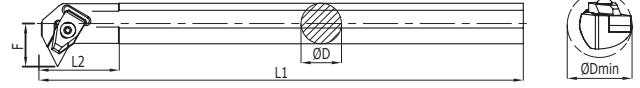

Kesici Uç Uyumluluğu Insert Suitability	Stok / Stock		Takım Ölçüleri / Dimension (mm)							Uç Insert	Altlık Shim	Vida Screw	Pabuç Clamp	Vida Screw	Anahtar Allen Key
	R	L	D	D min	F	L1	L2	λF	YP						
ISO															
TD-NR 001 ISO	✓	✓	32	43	26,5	300	60	-15	0	DNM. 1506..	DN..015	M4X10 A2.5	T150105	M6X27	A3
TD-NR 002 ISO	✓	✓	40	50	29,5	400	70	-13	0						
TD-NR 003 ISO	✓	✗	50	62	35	450	70	-13	0						

TCLNR ISO

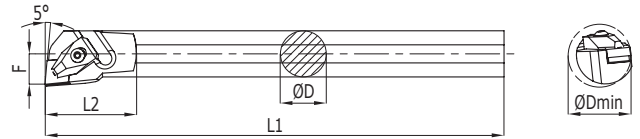

Kesici Uç Uyumluluğu Insert Suitability	Stok / Stock		Takım Ölçüleri / Dimension (mm)							Uç Insert	Altlık Shim	Vida Screw	Pabuç Clamp	Vida Screw	Anahtar Allen Key
	R	L	D	D min	F	L1	L2	λF	YP						
ISO															
TCLNR/S 001 ISO	✓	✓	25	32	17	250	50	-12	-5	CNM. 1204..	CN..012	M4X10 A2,5	T120105	M6X20	A3
TCLNR/S 002 ISO	✓	✓	32	40	22	300	60	-12	-5						
TCLNR/S 003 ISO	✓	✓	40	50	27	400	70	-12	-5						
TCLNR/S 004 ISO	✓	✓	50	63	35	450	75	-12	-5	CNM. 1606..	CN..16	M5X8 A3	T160105	M6X27	A3
TCLNR/S 005 ISO	✓	✓	32	40	22	300	60	-12	-5						
TCLNR/S 006 ISO	✓	✓	40	50	27	400	70	-12	-5	CNM. 1204..	CN..012	M4X10 A2,5	T120105	M6X27	A3
TCLNR/S 007 ISO	✓	✗	60	75	40	450	75	-12	-5						
TCLNR/S 008 ISO	✓	✓	40	50	27	400	70	-12	-5	CNM. 1606..	CN..16	M5X8 A3	T160105	M6X27	A3
TCLNR/S 009 ISO	✓	✗	50	63	35	450	75	-12	-5						

TWLN R ISO

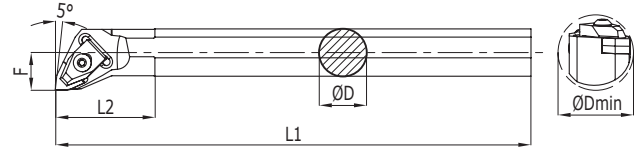

Kesici Uç Uyumluluğu Insert Suitability	Stok / Stock		Takım Ölçüleri / Dimension (mm)							Uç İnsert	Altlık Shim	Vida Screw	Pabuç Clamp	Vida Screw	Anahtar Allen Key				
	R	L	D	D min	F	L1	L2	λF	YP										
TWLN R/S 002 ISO	✓	✓	20	25	13	200	40	-11	-5	WNM. 0602..	-	-	T060105	M5X15	A3				
TWLN R/S 003 ISO	✓	✓	25	32	17	250	50	-13	-5					M6X20					
TWLN R/S 004 ISO	✓	✓	32	40	22	300	60	-12	-5					WNM. 0804..		WN.008(H)	M4X10 A2.5	T080105	M6X27
TWLN R/S 005 ISO	✓	X	40	50	27	400	70	-12	-5										
TWLN R/S 006 ISO	✓	X	50	63	35	450	75	-12	-5										
TWLN R/S 007 ISO	✓	X	60	75	40	450	75	-12	-5										

MTUNR ISO

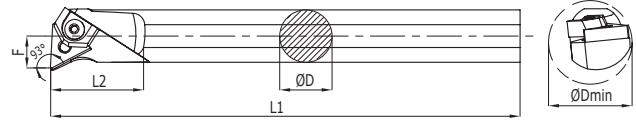

Kesici Uç Uyumluluğu Insert Suitability	Stok / Stock		Takım Ölçüleri / Dimension (mm)							Uç İnsert	Altlık Shim	Vida Screw	Pabuç Clamp	Vida Screw	Anahtar Allen Key
	R	L	D	D min	F	L1	L2	λF	YP						
ISO															
MTUNR 001 ISO	✓	✓	20	25	13	200	40	-13	-5	TNM. 1604..	-	5X3.6X12.5	M160105	M5X15	A3
MTUNR 002 ISO	✓	✓	25	32	17	250	50	-12	-5						
MTUNR 003 ISO	✓	✓	32	40	22	300	60	-12	-5						
MTUNR 004 ISO	✓	✓	40	50	27	400	70	-12	-5	TNM. 2204..	TN..022(P)	6X5X15	M220105	M6X27	
MTUNR 005 ISO	✓	✓	32	40	22	300	60	-12	-5						
MTUNR 006 ISO	✓	✓	40	50	27	400	70	-12	-5						
MTUNR 007 ISO	✓	✓	50	63	35	450	75	-12	-5						
MTUNR 008 ISO	✓	✗	60	75	40	450	75	-12	-5						

MT-NR ISO

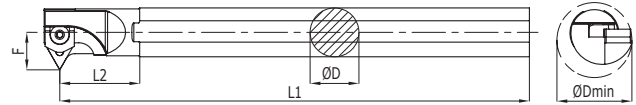

Kesici Uç Uyumluluğu Insert Suitability	Stok / Stock		Takım Ölçüleri / Dimension (mm)							Uç İnsert	Altlık Shim	Vida Screw	Pabuç Clamp	Vida Screw	Anahtar Allen Key
	R	L	D	D min	F	L1	L2	λF	YP						
ISO															
MT-NR 001 ISO	✓	✓	20	27	16	200	40	-15	-5	TNM. 1604..	-	5X3.6X12.5	M160105	M5X15	A3
MT-NR 002 ISO	✓	✓	25	33	19,5	250	50	-14	-5						
MT-NR 003 ISO	✓	✓	32	40	23	300	55	-13	-5						
MT-NR 004 ISO	✓	✓	40	50	29,5	400	70	-15	-5	TNM. 2204..	TN..022(P)	6X5X15	M220105	M6X27	
MT-NR 005 ISO	✓	✗	50	62	35	450	70	-15	-5						
MT-NR 006 ISO	✓	✗	32	40	23	300	55	-13	-5						
MT-NR 007 ISO	✓	✗	40	50	29,5	400	70	-15	-5						

MTQNR ISO

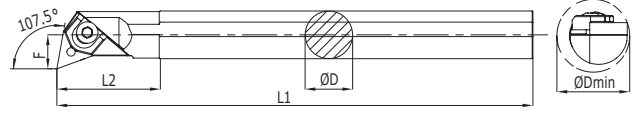

Kesici Uç Uyumluluğu Insert Suitability	Stok / Stock		Takım Ölçüleri / Dimension (mm)							Uç Insert	Altık Shim	Vida Screw	Pabuç Clamp	Vida Screw	Anahtar Allen Key
	R	L	D	D min	F	L1	L2	λF	YP						
ISO															
MTQNR 001 ISO	✓	✓	20	25	13	200	40	-13	-5	TNM. 1604..	-	5X3.6X12,5	M160105	M5X15	A3
MTQNR 002 ISO	✓	✓	25	32	17	250	50	-12	-5		TN..016(P)	5X3.6X15		M5X23	
MTQNR 003 ISO	✓	✓	32	40	22	300	60	-11	-5		TNM. 2204..	TN..022(P)	6X5X18	M6X27	
MTQNR 004 ISO	✓	✓	40	50	27	400	70	-11	-5						
MTQNR 005 ISO	✓	✓	32	40	22	300	60	-11	-5						
MTQNR 006 ISO	✓	✓	40	50	27	400	70	-11	-5						

MWLNR ISO

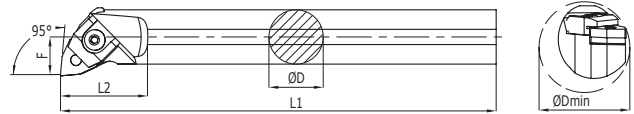

Kesici Uç Uyumluluğu Insert Suitability	Stok / Stock		Takım Ölçüleri / Dimension (mm)							Uç Insert	Altık Shim	Vida Screw	Pabuç Clamp	Vida Screw	Anahtar Allen Key				
	R	L	D	D min	F	L1	L2	λF	YP										
ISO																			
MWLNR/S 001 ISO	✓	✓	16	22	11	180	35	-13	-5	WNM. 0604..	-	5x3,6x15	M060105	M5X15	A3				
MWLNR/S 002 ISO	✓	✓	20	25	13	200	40	-13	-5					M6X20					
MWLNR/S 003 ISO	✓	✓	25	32	17	250	50	-13	-5	WNM. 0804..	TN..022(P)	6X5X15	M080105	M6X27					
MWLNR/S 004 ISO	✓	✓	32	40	22	300	60	-12	-5										
MWLNR/S 005 ISO	✓	✓	40	50	27	400	70	-14	-5										
MWLNR/S 006 ISO	✓	✓	50	63	35	450	75	-12	-5										
MWLNR/S 007 ISO	X	X	60	75	40	450	75	-12	-5										

PCLNR ISO

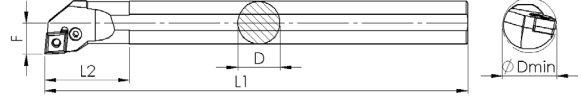

Kesici Uç Uyumluluğu Insert Suitability	Stok / Stock		Takım Ölçüleri / Dimension (mm)							Uç İnsert	Altlık Shim	Vida Screw	Levye Crowbar	Altlık Sacı Metal Sheet	Anahtar Allen Key
	R	L	D	D min	F	L1	L2	λF	YP						
ISO															
PCLNR/S 001 ISO	✓	X	25	32	17	250	50	-12	-5	CNM. 1204..	CN..012	MPV M8 K	MPL 012	MPS 012	A3
PCLNR/S 002 ISO	✓	X	32	40	22	300	60	-12	-5						
PCLNR/S 003 ISO	✓	✓	40	50	27	400	70	-12	-5						
PCLNR/S 004 ISO	✓	X	32	40	22	300	60	-12	-5	CNM. 1606..	CN..16	MPL 016	MPS 016		
PCLNR/S 005 ISO	✓	X	40	50	27	400	70	-12	-5	CNM. 1906..	CN..019	MPL 019	MPS 019		
PCLNR/S 007 ISO	✓	X	40	50	27	400	70	-12	-5						
PCLNR/S 008 ISO	✓	X	50	63	35	450	75	-12	-5						

PDUNR ISO

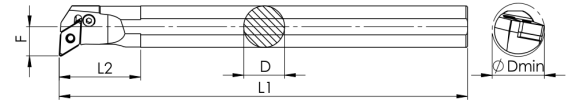

Kesici Uç Uyumluluğu Insert Suitability	Stok / Stock		Takım Ölçüleri / Dimension (mm)							Uç İnsert	Altlık Shim	Vida Screw	Levye Crowbar	Altlık Sacı Metal Sheet	Anahtar Allen Key
	R	L	D	D min	F	L1	L2	λF	YP						
ISO															
PDUNR/S 001 ISO	✓	X	25	32	17	250	50	-13	-5	DNM. 1506..	DN..015	MPV M8 K	MPL 012	MPS 012	A3
PDUNR/S 002 ISO	✓	X	32	40	22	300	60	-12	-5						
PDUNR/S 003 ISO	✓	X	40	50	27	400	70	-12	-5						

PWLNK ISO

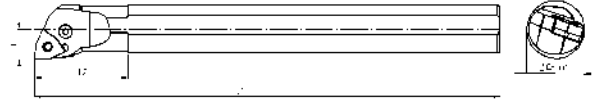

Kesici Uç Uyumluluğu Insert Suitability	Stok / Stock		Takım Ölçüleri / Dimension (mm)							Uç Insert	Altık Shim	Vida Screw	Levye Crowbar	Altık Sacı Metal Sheet	Anahtar Allen Key
	R	L	D	D min	F	L1	L2	λF	YP						
ISO															
PWLNK/S 001 ISO	✓	✗	25	32	17	250	40	-6	-6	WNM. 0804..	WN..008(H)	MPV M8 K	MPL 012	MPS 012	A3
PWLNK/S 002 ISO	✓	✗	32	40	22	300	40	-6	-6						
PWLNK/S 003 ISO	✓	✗	40	50	27	400	45	-6	-6						

PTUNR ISO

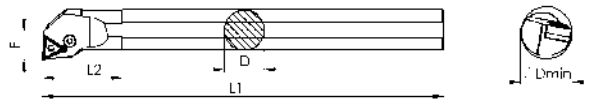





Kesici Uç Uyumluluğu Insert Suitability	Stok / Stock		Takım Ölçüleri / Dimension (mm)							Uç Insert	Altık Shim	Vida Screw	Levye Crowbar	Altık Sacı Metal Sheet	Anahtar Allen Key
	R	L	D	D min	F	L1	L2	λF	YP						
ISO															
PTUNR/S 001 ISO	✗	✗	20	25	13	200	40	-13	-5	TNM. 1604..	TN..016(P)	MPV M8 K	MPL 016	MPS 016	A3
PTUNR/S 002 ISO	✗	✗	25	32	17	250	50	-12	-5						
PTUNR/S 003 ISO	✗	✗	32	40	22	300	60	-12	-5						
PTUNR/S 005 ISO	✓	✗	32	40	22	300	60	-12	-5	TNM. 2204..	TN..022(P)	MPL 022	MPS 022	A3	
PTUNR/S 006 ISO	✓	✗	40	50	27	400	70	-12	-5						

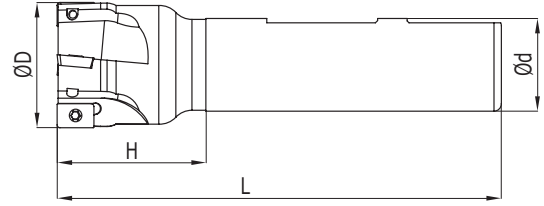

ŞAFTLI TARAMALAR END MILLS



APKT 1003 ISO

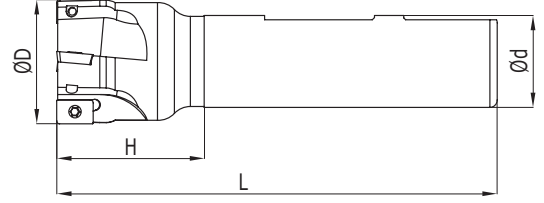

Kesici Uç Uyumluluğu Insert Suitability	Stok / Stock		Takım Ölçüleri / Dimension (mm)					Uç Insert	Vida Screw	Anahtar Torx Key
	ISO AP..1003	Inter Cooland	D	Z	H	L	d			
ST AP..10 001 ISO	✓	✓	12	1	40	120	12	AP..1003..	M2.5X6	T08
ST AP..10 002 ISO	✓	✗	14	1	30	120	12			
ST AP..10 003 ISO	✓	✓	16	2	35	100	16			
ST AP..10 004 ISO	✓	✓	16	2	40	120	16			
ST AP..10 005 ISO	✓	✓	16	2	50	150	16			
ST AP..10 006 ISO	✓	✓	16	2	50	200	16			
ST AP..10 007 ISO	✓	✗	16	2	60	250	16			
ST AP..10 008 ISO	✓	✓	18	2	30	100	16			
ST AP..10 009 ISO	✓	✓	18	2	30	120	16			
ST AP..10 010 ISO	✓	✓	18	2	30	150	16			
ST AP..10 011 ISO	✓	✓	18	2	30	200	16			
ST AP..10 012 ISO	✓	✓	20	3	35	100	20			
ST AP..10 013 ISO	✓	✓	20	3	40	120	20			
ST AP..10 014 ISO	✓	✗	18	2	30	250	16			
ST AP..10 015 ISO	✓	✓	20	3	50	150	20			
ST AP..10 016 ISO	✓	✓	20	3	60	200	20			
ST AP..10 017 ISO	✓	✗	20	3	60	250	20			
ST AP..10 018 ISO	✓	✓	22	3	30	100	20			
ST AP..10 019 ISO	✓	✓	22	3	30	120	20			
ST AP..10 020 ISO	✓	✓	22	3	30	150	20			
ST AP..10 021 ISO	✓	✓	22	3	30	200	20			
ST AP..10 022 ISO	✓	✗	22	3	30	250	20			
ST AP..10 023 ISO	✓	✓	25	3	35	100	25			
ST AP..10 024 ISO	✓	✓	25	3	40	120	25			
ST AP..10 025 ISO	✓	✓	25	3	50	150	25			
ST AP..10 026 ISO	✓	✓	25	3	60	200	25			
ST AP..10 027 ISO	✓	✗	25	3	60	250	25			
ST AP..10 028 ISO	✓	✗	28	4	30	150	25			
ST AP..10 029 ISO	✓	✗	26	3	30	150	25			

APKT 1003 ISO



Kesici Uç Uyumluluğu Insert Suitability	Stok / Stock		Takım Ölçüleri / Dimension (mm)					Uç Insert	Vida Screw	Anahtar Torx Key
		Inter Cooland	D	Z	H	L	d			
ISO AP..1003										
ST AP..10 030 ISO	✓	✓	26	3	30	200	25	AP..1003..	M2.5X7	T08
ST AP..10 031 ISO	✓	✗	26	3	30	250	25		M2.5X7	
ST AP..10 032 ISO	✓	✓	30	4	30	100	25		M2.5X7	
ST AP..10 033 ISO	✓	✓	30	4	30	120	25		M2.5X7	
ST AP..10 034 ISO	✓	✓	30	3	30	150	25		M2.5X7	
ST AP..10 035 ISO	✓	✓	30	4	30	150	25		M2.5X7	
ST AP..10 036 ISO	✓	✓	30	4	30	200	25		M2.5X7	
ST AP..10 037 ISO	✓	✗	30	3	30	300	25		M2.5X7	
ST AP..10 038 ISO	✓	✓	32	4	40	150	25		M2.5X7	
ST AP..10 039 ISO	✓	✗	32	4	50	150	32		M2.5X7	
ST AP..10 040 ISO	✓	✓	32	4	60	200	32		M2.5X7	
ST AP..10 041 ISO	✓	✓	35	4	40	100	25		M2.5X7	
ST AP..10 042 ISO	✓	✓	35	4	40	120	25		M2.5X7	
ST AP..10 043 ISO	✓	✓	35	4	40	150	25		M2.5X7	
ST AP..10 044 ISO	✓	✓	35	4	40	200	25		M2.5X7	
ST AP..10 045 ISO	✓	✗	35	4	35	100	32		M2.5X7	
ST AP..10 046 ISO	✓	✗	35	4	40	120	32		M2.5X7	
ST AP..10 047 ISO	✓	✗	35	4	50	150	32		M2.5X7	
ST AP..10 048 ISO	✓	✓	40	5	40	100	25		M2.5X7	
ST AP..10 049 ISO	✓	✓	40	5	40	120	25		M2.5X7	
ST AP..10 050 ISO	✓	✓	40	5	40	150	25		M2.5X7	
ST AP..10 051 ISO	✓	✓	40	5	40	200	25		M2.5X7	
ST AP..10 052 ISO	✓	✗	40	5	40	100	32		M2.5X7	
ST AP..10 053 ISO	✓	✓	40	5	40	120	32		M2.5X7	
ST AP..10 054 ISO	✓	✓	40	5	40	150	32		M2.5X7	
ST AP..10 055 ISO	✓	✓	40	5	40	150	32		M2.5X7	
ST AP..10 056 ISO	✓	✓	17	2	30	150	16		M2.5X7	
ST AP..10 057 ISO	✓	✓	21	3	30	150	20		M2.5X7	
ST AP..10 058 ISO	✓	✓	21	3	30	200	20		M2.5X7	

Lütfen Sipariş vermeden önce stok durumunu sorunuz.
Please ask before ordering, stock status.

L: Sol / Left

R: Sağ / Right

✓ Stokta / In Stock

✗ Stokta Yok / Non Stock

APKT 1604 ISO

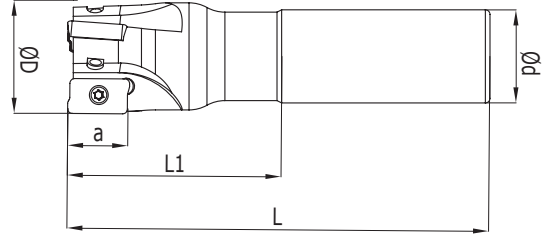

Kesici Uç Uyumluluğu Insert Suitability	Stok / Stock		Takım Ölçüleri / Dimension (mm)					Uç İnsert	Vida Screw	Anahtar Torx Key
	ISO AP..1604..	Inter Cooland	D	Z	H	L	d			
ST AP..16 001 ISO	✓	✓	25	23	7	100	25	AP..1604..	M3.5X8	T15
ST AP..16 002 ISO	✓	✓	25	2	41	120	25			
ST AP..16 003 ISO	✓	✓	25	2	50	150	25			
ST AP..16 004 ISO	✓	✓	25	2	70	200	25			
ST AP..16 005 ISO	✓	X	25	2	70	250	25			
ST AP..16 006 ISO	✓	X	25	2	70	300	25			
ST AP..16 007 ISO	✓	✓	30	3	41	100	25			
ST AP..16 008 ISO	✓	✓	30	3	41	120	25			
ST AP..16 009 ISO	✓	✓	30	3	41	150	25			
ST AP..16 010 ISO	✓	✓	30	3	41	200	25			
ST AP..16 011 ISO	✓	X	30	3	41	250	25			
ST AP..16 012 ISO	✓	X	30	3	41	300	25			
ST AP..16 013 ISO	✓	✓	32	3	41	100	25			
ST AP..16 014 ISO	✓	✓	32	3	41	120	25			
ST AP..16 015 ISO	✓	✓	32	3	41	150	25			
ST AP..16 016 ISO	✓	✓	32	3	41	200	25			
ST AP..16 017 ISO	✓	✓	32	3	35	100	32			
ST AP..16 018 ISO	✓	✓	32	3	35	120	32			
ST AP..16 019 ISO	✓	✓	32	3	50	150	32			
ST AP..16 020 ISO	✓	✓	32	3	60	200	32			
ST AP..16 021 ISO	✓	X	32	3	70	250	32			
ST AP..16 022 ISO	✓	X	32	3	70	300	32			
ST AP..16 023 ISO	✓	X	32	3	100	350	32			
ST AP..16 024 ISO	✓	✓	35	3	41	100	25			
ST AP..16 025 ISO	✓	✓	35	3	41	120	25			
ST AP..16 026 ISO	✓	✓	35	3	55	150	25			
ST AP..16 027 ISO	✓	✓	35	3	41	100	32			
ST AP..16 028 ISO	✓	✓	35	3	41	120	32			
ST AP..16 029 ISO	✓	✓	35	3	41	150	32			
ST AP..16 030 ISO	✓	✓	35	3	41	200	32			
ST AP..16 031 ISO	✓	X	35	3	41	250	32			
ST AP..16 032 ISO	✓	X	35	3	41	300	32			
ST AP..16 033 ISO	✓	X	35	3	41	350	32			
ST AP..16 034 ISO	✓	✓	40	4	41	100	25			
ST AP..16 035 ISO	✓	✓	40	4	41	120	25			
ST AP..16 036 ISO	✓	✓	40	4	41	150	25			
ST AP..16 037 ISO	✓	✓	40	4	41	200	25			
ST AP..16 038 ISO	✓	✓	40	4	46	100	32			
ST AP..16 039 ISO	✓	✓	40	4	46	120	32			
ST AP..16 040 ISO	✓	✓	40	4	46	150	32			
ST AP..16 041 ISO	✓	✓	40	4	46	200	32			
ST AP..16 042 ISO	✓	X	40	4	46	250	32			
ST AP..16 043 ISO	✓	X	40	4	46	300	32			
ST AP..16 044 ISO	✓	X	40	4	46	350	32			
ST AP..16 045 ISO	✓	X	23,5	2	30	150	25			
ST AP..16 046 ISO	✓	X	24	2	30	150	25			
ST AP..16 047 ISO	✓	X	32	3	30	250	25			
ST AP..16 048 ISO	✓	X	32	4	30	350	25			

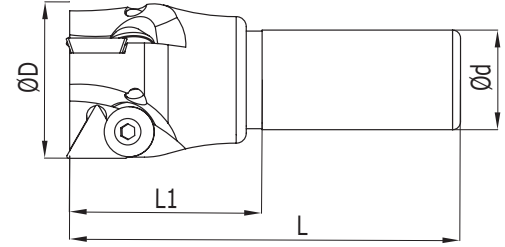

Kesici Uç Uyumluluğu Insert Suitability	Stok / Stock		Takım Ölçüleri / Dimension (mm)					Uç Insert	Vida Screw	Anahtar Allen Key
	ISO	Inter Cooland	D	Z	L1	L	d			
ST TPKN 16 001 ISO	✓	X	35	2	40	100	25	TPKN 1603	M6X0.75	A4
ST TPKN 16 002 ISO	✓	X	40	3	40	100	25			
ST TPKN 16 003 ISO	✓	X	50	3	40	100	25			



Kesici Uç Uyumluluğu Insert Suitability	Stok / Stock		Takım Ölçüleri / Dimension (mm)					Uç Insert	Vida Screw	Anahtar Torx Key
	ISO	Inter Cooland	D	Z	L1	L	d			
VCGT 160408 220530								VCGT 1604	M4X11	T15
ST VCGT 16 001 ISO	✓	X	32	3	70	300	32			
ST VCGT 22 001 ISO	✓	X	32	2	70	250	32			
ST VCGT 22 002 ISO	✓	X	33	2	40	250	32	VCGT 2205	M5X12	T20

QXMT 17 ISO

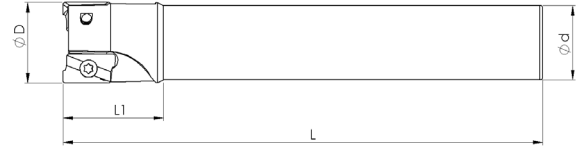





Kesici Uç Uyumluluğu Insert Suitability	Stok / Stock		Takım Ölçüleri / Dimension (mm)					Uç Insert	Vida Screw	Anahtar Torx Key
		Inter Cooland	D	Z	L1	L	d			
ISO QXMT 17										
ST QXMT 17 001 ISO	X	X	25	2	70	150	25	QXMT 17	M4X8	T15
ST QXMT 17 002 ISO	X	X	28	2	50	150	25			
ST QXMT 17 003 ISO	✓	X	28	2	50	160	25			
ST QXMT 17 004 ISO	X	X	35	3	50	150	25			

APMT 1135 SNG

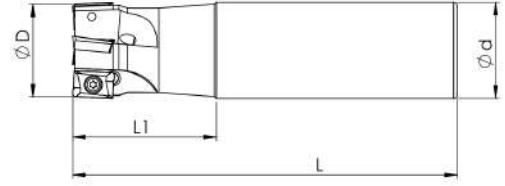



Kesici Uç Uyumluluğu Insert Suitability	Stok / Stock		Takım Ölçüleri / Dimension (mm)					Uç Insert	Vida Screw	Anahtar Torx Key
		Inter Cooland	D	Z	L1	L	d			
SNG APMT 1135										
ST APMT 11 001 SNG	✓	✓	16	2	30	160	15	APMT 1135	M2.5X6	T08
ST APMT 11 002 SNG	✓	✓	16	2	50	160	16		M2.5X6	
ST APMT 11 003 SNG	✓	✓	16	2	60	200	16		M2.5X6	
ST APMT 11 004 SNG	✓	✓	17	2	30	160	16		M2.5X6	
ST APMT 11 005 SNG	✓	✓	17	2	30	200	16		M2.5X6	
ST APMT 11 006 SNG	✓	✓	20	3	50	160	20		M2.5X6	
ST APMT 11 007 SNG	✓	✓	20	3	60	200	20		M2.5X6	
ST APMT 11 008 SNG	✓	✓	21	3	30	160	20		M2.5X6	
ST APMT 11 009 SNG	✓	✓	21	3	30	200	20		M2.5X6	
ST APMT 11 010 SNG	✓	✓	25	3	50	160	25		M2.5X7	
ST APMT 11 011 SNG	✓	✓	25	3	60	200	25		M2.5X7	
ST APMT 11 012 SNG	✓	✓	26	3	30	160	25		M2.5X7	
ST APMT 11 013 SNG	✓	✓	32	4	50	160	32		M2.5X7	
ST APMT 11 014 SNG	✓	✓	33	4	40	160	32		M2.5X7	
ST APMT 11 015 SNG	✓	✓	33	4	40	200	32		M2.5X7	
ST APMT 11 016 SNG	✓	✓	26	3	30	200	25		M2.5X7	

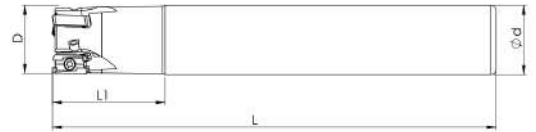

Kesici Uç Uyumluluğu Insert Suitability	Stok / Stock		Takım Ölçüleri / Dimension (mm)					Uç Insert	Vida Screw	Anahtar Torx Key
		Inter Cooland	D	Z	L1	L	d			
SNG APMT 1035										
ST APMT 10 001 SNG	X	✓	16	2	35	100	16	APMT 1035	M2,5X6	T8
ST APMT 10 003 SNG	X	✓	20	3	35	100	20			
ST APMT 10 005 SNG	X	✓	25	4	35	100	25			
ST APMT 10 007 SNG	X	✓	32	4	40	150	32			



Kesici Uç Uyumluluğu Insert Suitability	Stok / Stock		Takım Ölçüleri / Dimension (mm)					Uç Insert	Vida Screw	Anahtar Torx Key
		Inter Cooland	D	Z	L1	L	d			
SNG LNGX 1104										
ST LNGX 11 002 SNG	✓	✓	20	2	50	150	20	LNGX 1104	M3X8	T10
ST LNGX 11 003 SNG	✓	✓	25	3	50	150	25			

3PGX 1004/1505 SNG

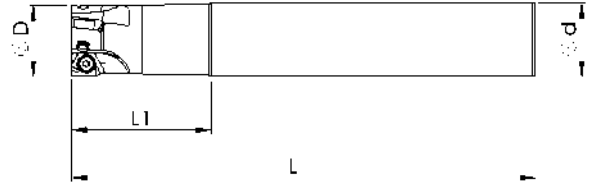

Kesici Uç Uyumluluğu Insert Suitability	Stok / Stock		Takım Ölçüleri / Dimension (mm)					Uç İnsert	Vida Screw	Anahtar Torx Key
		Inter Cooland	D	Z	L1	L	d			
SNG 3PGX 1004/1505										
ST 3PGX 10 001 SNG	✓	✓	20	2	50	150	20	3PGX 1004	M3X8	T10
ST 3PGX 10 002 SNG	✓	✓	25	3	50	150	25			
ST 3PGX 10 003 SNG	✓	✓	32	4	50	150	32			
ST 3PGX 15 001 SNG	✓	✓	32	3	60	200	32	3PGX 1505	M4,5X12	T20

ADKX 1204 FTTE

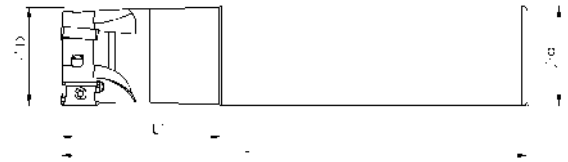

Kesici Uç Uyumluluğu Insert Suitability	Stok / Stock		Takım Ölçüleri / Dimension (mm)					Uç İnsert	Vida Screw	Anahtar Torx Key
		Inter Cooland	D	Z	L1	L	d			
LMT FTTE ADKX 1204										
ST ADKX 12 001 FTTE	✓	X	12	1	30	80	12	ADKX 1204	M3X6	T10
ST ADKX 12 002 FTTE	X	X	16	2	30	140	14			
ST ADKX 12 003 FTTE	X	X	16	2	40	140	16			
ST ADKX 12 004 FTTE	X	X	20	2	30	171	18			
ST ADKX 12 005 FTTE	X	X	20	2	35	90	20			
ST ADKX 12 006 FTTE	X	X	20	2	50	171	20			
ST ADKX 12 007 FTTE	✓	X	25	2	35	100	25			
ST ADKX 12 008 FTTE	✓	X	25	2	50	171	25			
ST ADKX 12 009 FTTE	X	X	25	3	30	171	20			
ST ADKX 12 010 FTTE	X	X	25	3	35	100	25			
ST ADKX 12 011 FTTE	✓	X	32	3	35	111	32			
ST ADKX 12 012 FTTE	X	X	32	3	60	201	32			
ST ADKX 12 013 FTTE	✓	X	32	4	60	201	32			

AOMT 1848 MTSBSH

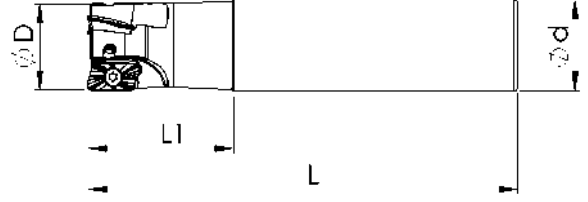

Kesici Uç Uyumluluğu Insert Suitability	Stok / Stock		Takım Ölçüleri / Dimension (mm)					Uç Insert	Vida Screw	Anahtar Torx Key
		Inter Cooland	D	Z	L1	L	d			
MTSBSH AOMT 184804										
ST AOMT 18 001 MTSBSH	✓	X	25	2	50	150	25	AOMT 1848	M4X11	T15
ST AOMT 18 002 MTSBSH	✓	X	32	3	50	150	32			

AOMT 1236 MTSBSH

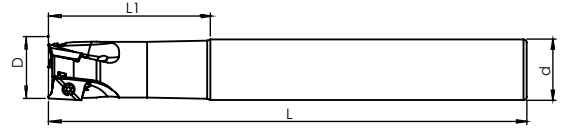

Kesici Uç Uyumluluğu Insert Suitability	Stok / Stock		Takım Ölçüleri / Dimension (mm)					Uç Insert	Vida Screw	Anahtar Torx Key
		Inter Cooland	D	Z	L1	L	d			
MTSBSH AOMT 1236										
ST AOMT 12 001 MTSBSH	✓	✓	16	2	50	150	16	AOMT 1236	M2.5X6	T8
ST AOMT 12 002 MTSBSH	✓	✓	17	2	30	150	16			
ST AOMT 12 003 MTSBSH	✓	✓	20	3	50	150	20			
ST AOMT 12 004 MTSBSH	✓	✓	21	3	30	150	20			
ST AOMT 12 005 MTSBSH	✓	✓	25	4	30	150	24			
ST AOMT 12 006 MTSBSH	✓	✓	25	4	50	150	25			
ST AOMT 12 007 MTSBSH	✓	✓	32	4	50	150	32			
ST AOMT 12 008 MTSBSH	✓	✓	32	4	50	160	32			
ST AOMT 12 009 MTSBSH	✓	✓	16	2	200	50	16			
ST AOMT 12 010 MTSBSH	✓	✓	20	3	200	50	20			
ST AOMT 12 011 MTSBSH	✓	✓	32	4	200	50	32			
ST AOMT 12 012 MTSBSH	✓	✓	25	4	200	50	25			

APMT 11T3..

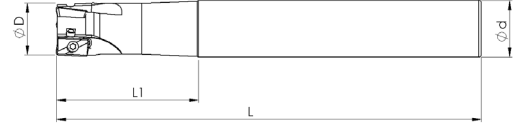

Kesici Uç Uyumluluğu Insert Suitability	Stok / Stock		Takım Ölçüleri / Dimension (mm)					Uç İnsert	Vida Screw	Anahtar Torx Key
		Inter Cooland	D	Z	L1	L	d			
APMT 11T3..										
ST APMT 11 001	✓	X	16	2	35	90	25	APMT 11T3..	M2.5X6	T08
ST APMT 11 002	✓	X	16	2	40	120	16			
ST APMT 11 003	✓	X	16	2	50	150	16			
ST APMT 11 004	✓	X	17	2	30	120	16			
ST APMT 11 005	✓	X	17	2	30	200	16			
ST APMT 11 006	✓	X	18	2	30	100	16			
ST APMT 11 007	✓	X	18	2	30	120	16			
ST APMT 11 008	✓	X	20	3	40	120	20			
ST APMT 11 009	✓	X	20	3	50	150	20			
ST APMT 11 010	✓	X	21	3	30	120	20			
ST APMT 11 011	✓	X	21	3	30	140	20	M2.5X7	T08	
ST APMT 11 012	✓	X	22	3	30	120	20			
ST APMT 11 013	✓	X	22	3	30	150	20			
ST APMT 11 014	✓	X	25	3	40	120	25			
ST APMT 11 015	✓	X	25	3	50	150	25			
ST APMT 11 016	✓	X	25	3	60	200	25			
ST APMT 11 017	✓	X	30	4	30	120	25			
ST APMT 11 018	✓	X	30	4	30	150	25			
ST APMT 11 019	✓	X	32	4	60	200	32			
ST APMT 11 022	✓	X	18	2	30	150	16			

XO..0903 SCO

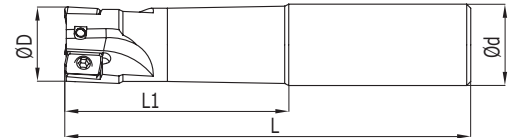

Kesici Uç Uyumluluğu Insert Suitability	Stok / Stock		Takım Ölçüleri / Dimension (mm)					Uç İnsert	Vida Screw	Anahtar Torx Key
		Inter Cooland	D	Z	L1	L	d			
SCO XO..0903..										
ST XO..09 001 SCO	✓	✓	16	2	35	100	16	XO..0903..	M2.5X6	T08
ST XO..09 002 SCO	✓	X	16	2	40	130	16			
ST XO..09 003 SCO	✓	X	16	2	50	150	16			
ST XO..09 004 SCO	✓	✓	16	2	60	200	16			
ST XO..09 005 SCO	✓	✓	20	3	40	120	20		M2.5X7	
ST XO..09 006 SCO	✓	X	20	3	50	150	20			
ST XO..09 007 SCO	✓	X	20	3	60	200	20			
ST XO..09 008 SCO	✓	X	25	3	50	150	25			

XOMX 1204 SCO

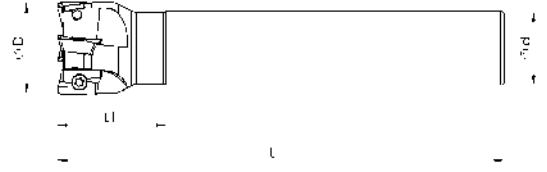

Kesici Uç Uyumluluğu Insert Suitability	Stok / Stock		Takım Ölçüleri / Dimension (mm)					Uç Insert	Vida Screw	Anahtar Torx Key
		Inter Cooland	D	Z	L1	L	d			
SCO XOMX 1204..										
ST XOMX 12 001 SCO	✓	✗	16	2	40	120	16	XOMX..1204	M3.5X6	T15
ST XOMX 12 002 SCO	✓	✗	16	1	50	150	16			
ST XOMX 12 003 SCO	✓	✗	20	2	35	100	20			
ST XOMX 12 004 SCO	✓	✓	20	2	40	120	20		M3.5X8	
ST XOMX 12 005 SCO	✓	✗	20	2	50	150	20			
ST XOMX 12 006 SCO	✓	✗	22	2	30	150	20		M3.5X6	
ST XOMX 12 007 SCO	✓	✓	25	3	40	120	25			
ST XOMX 12 008 SCO	✓	✓	25	3	50	150	25			
ST XOMX 12 009 SCO	✓	✓	32	4	40	150	25		M3.5X8	
ST XOMX 12 010 SCO	✓	✗	25	3	35	100	25			
ST XOMX 12 011 SCO	✓	✗	20	2	60	200	20		M3.5X8	
ST XOMX 12 012 SCO	✓	✗	25	3	60	200	25			
ST XOMX 12 013 SCO	✓	✗	32	4	40	200	25			

XNEX 0403 SCO

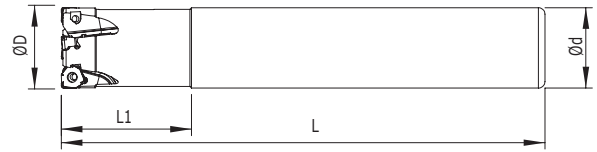

Kesici Uç Uyumluluğu Insert Suitability	Stok / Stock		Takım Ölçüleri / Dimension (mm)					Uç Insert	Vida Screw	Anahtar Torx Key
		Inter Cooland	D	Z	L1	L	d			
SCO XNEX 0403										
ST XNEX 04 001 SCO	✓	✓	18	2	35	150	16	XNEX..0403	M2.5X7	T08
ST XNEX 04 002 SCO	✓	✓	18	2	30	200	16			
ST XNEX 04 003 SCO	✓	✓	20	3	50	150	20			
ST XNEX 04 004 SCO	✓	✓	21	3	30	150	20			
ST XNEX 04 005 SCO	✓	✓	21	3	30	200	20			
ST XNEX 04 006 SCO	✓	✓	25	4	50	150	25			
ST XNEX 04 007 SCO	✓	✓	26	4	30	150	25			
ST XNEX 04 008 SCO	✓	✓	32	4	50	150	32			
ST XNEX 04 009 SCO	✓	✓	25	4	60	200	25			
ST XNEX 04 010 SCO	✓	✓	26	4	30	200	25			
ST XNEX 04 011 SCO	✓	✓	32	4	60	200	32			

Lütfen Sipariş vermeden önce stok durumunu sorunuz.
Please ask before ordering, stock status.

L: Sol / Left



R: Sağ / Right

✓ Stokta / In Stock

✗ Stokta Yok / Non Stock

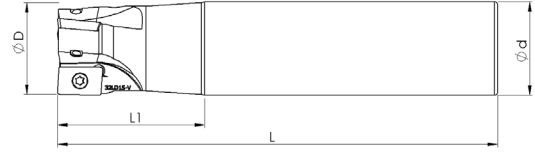
LDEW 1503 SCO



Kesici Uç Uyumluluğu Insert Suitability	Stok / Stock		Takım Ölçüleri / Dimension (mm)					Uç Insert	Vida Screw	Anahtar Torx Key
		Inter Cooland	D	Z	L1	L	d			
SCO LDEW 1503										
ST LDEW 15 001 SCO	✓	X	25	2	50	150	25	LDEW 1503	M3,5X8	T15
ST LDEW 15 002 SCO	✓	X	32	3	50	150	32			

APKT 1604 ZCC

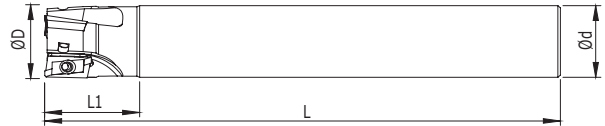

Kesici Uç Uyumluluğu Insert Suitability	Stok / Stock		Takım Ölçüleri / Dimension (mm)					Uç Insert	Vida Screw	Anahtar Torx Key
		Inter Cooland	D	Z	L1	L	d			
ZCC APKT 1604..										
ST APKT 16 001 ZCC	✓	X	25	2	50	170	25	APKT 1604..	M4X9	T15
ST APKT 16 002 ZCC	✓	X	26	2	30	200	25			
ST APKT 16 003 ZCC	✓	X	32	3	50	170	32			
ST APKT 16 004 ZCC	✓	X	26	2	30	250	25			
ST APKT 16 026 ZCC	✓	X	33	3	40	200	32			
ST APKT 16 027 ZCC	✓	X	33	3	40	250	32			
ST APKT 16 028 ZCC	✓	X	33	3	40	300	32			
ST APKT 16 029 ZCC	✓	X	33	3	40	350	32			
ST APKT 16 030 ZCC	✓	X	33	3	40	400	32			

APKT 11T3 ZCC

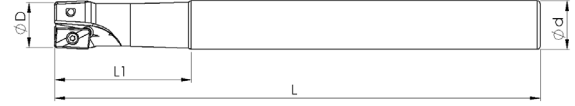

Kesici Uç Uyumluluğu Insert Suitability	Stok / Stock		Takım Ölçüleri / Dimension (mm)					Uç Insert	Vida Screw	Anahtar Torx Key
		Inter Cooland	D	Z	L1	L	d			
ZCC APKT 11T3										
ST APKT 11 001 ZCC	✓	✓	16	2	50	160	16	APKT 11T3	M2.5X6	T08
ST APKT 11 002 ZCC	✓	✓	16	2	60	200	16			
ST APKT 11 003 ZCC	✓	✗	17	2	30	160	16			
ST APKT 11 004 ZCC	✓	✗	17	2	30	200	16			
ST APKT 11 005 ZCC	✓	✗	17	2	30	250	16			
ST APKT 11 006 ZCC	✓	✗	18	2	30	160	16			
ST APKT 11 007 ZCC	✓	✓	20	3	50	160	20			
ST APKT 11 008 ZCC	✓	✗	21	3	30	160	20			
ST APKT 11 009 ZCC	✓	✗	21	3	30	200	20			
ST APKT 11 010 ZCC	✓	✗	21	3	30	250	20			
ST APKT 11 011 ZCC	✓	✗	25	3	50	160	25			
ST APKT 11 012 ZCC	✓	✗	26	3	30	150	25			
ST APKT 11 013 ZCC	✓	✗	26	3	30	200	25			
ST APKT 11 014 ZCC	✓	✗	26	3	30	250	25			
ST APKT 11 015 ZCC	✓	✓	20	3	60	200	20			
ST APKT 11 016 ZCC	✓	✗	16	2	35	100	16			
ST APKT 11 017 ZCC	✓	✗	20	3	40	120	20			
ST APKT 11 018 ZCC	✓	✗	25	3	40	120	25			
ST APKT 11 019 ZCC	✓	✗	25	3	60	200	25			
ST APKT 11 020 ZCC	✓	✗	32	4	70	200	32			

APKT 0702 ZCC

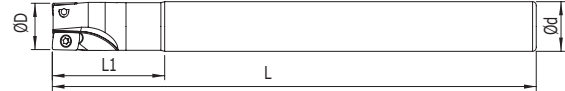

Kesici Uç Uyumluluğu Insert Suitability	Stok / Stock		Takım Ölçüleri / Dimension (mm)					Uç Insert	Vida Screw	Anahtar Torx Key
		Inter Cooland	D	Z	L1	L	d			
ZCC APKT 0702										
ST AP..07 001 ZCC	✓	✗	10	2	30	130	10	APKT 0702	M1,8X4,2	T06
ST AP..07 002 ZCC	✓	✗	12	2	30	130	10			
ST AP..07 003 ZCC	✓	✗	12	2	30	130	12			
ST AP..07 004 ZCC	✓	✗	14	3	30	130	12			
ST AP..07 005 ZCC	✓	✗	16	3	30	150	14			
ST AP..07 007 ZCC	✓	✗	10	2	30	130	9			
ST AP..07 008 ZCC	✓	✗	12	2	30	150	10			
ST AP..07 009 ZCC	✓	✗	12	2	30	150	12			
ST AP..07 010 ZCC	✓	✗	14	2	30	150	12			

Lütfen Sipariş vermeden önce stok durumunu sorunuz.
Please ask before ordering, stock status.

L: Sol / Left

R: Sağ / Right

✓ Stokta / In Stock

✗ Stokta Yok / Non Stock

ANGX 1105 ZCC

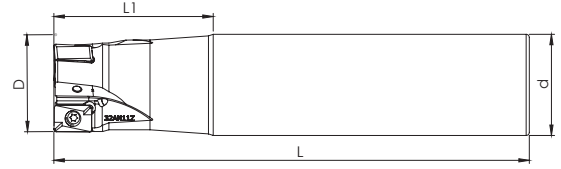

Kesici Uç Uyumluluğu Insert Suitability	Stok / Stock		Takım Ölçüleri / Dimension (mm)					Uç Insert	Vida Screw	Anahtar Torx Key
		Inter Cooland	D	Z	L1	L	d			
ZCC ANGX 1105										
ST ANGX 11 001 ZCC	✓	✓	25	2	50	150	25	ANGX 1135..	M3X8	T10
ST ANGX 11 002 ZCC	✓	✓	32	3	50	150	32			
ST ANGX 11 003 ZCC	X	✓	40	4	35	150	32			

LNKT 0804 ZCC



Kesici Uç Uyumluluğu Insert Suitability	Stok / Stock		Takım Ölçüleri / Dimension (mm)					Uç Insert	Vida Screw	Anahtar Torx Key
		Inter Cooland	D	Z	L1	L	d			
ZCC LNKT 0804										
ST LNKT 08 001 ZCC	✓	✓	20	2	50	160	20	LNKT 0804	M3X8	T10
ST LNKT 08 002 ZCC	✓	✓	25	3	50	160	25			
ST LNKT 08 003 ZCC	✓	✓	32	4	35	160	32			

WNHU 0604 ZCC

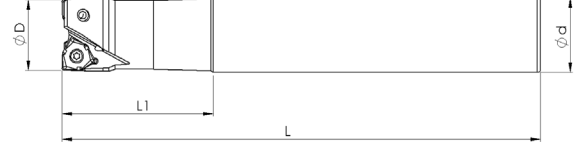

Kesici Uç Uyumluluğu Insert Suitability	Stok / Stock		Takım Ölçüleri / Dimension (mm)					Uç Insert	Vida Screw	Anahtar Torx Key
		Inter Cooland	D	Z	L1	L	d			
ZCC WNHU 0806										
ST WNHU 06 001 ZCC	✓	✓	25	2	50	160	25	WNHU 0806	M3X8	T10
ST WNHU 06 002 ZCC	✓	✓	26	2	30	200	25			
ST WNHU 06 003 ZCC	✓	✓	32	3	50	160	32			
ST WNHU 06 004 ZCC	✓	✓	33	3	30	200	32			

VCGX 1103 ZCC

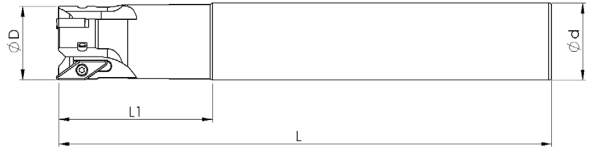

Kesici Uç Uyumluluğu Insert Suitability	Stok / Stock		Takım Ölçüleri / Dimension (mm)					Uç Insert	Vida Screw	Anahtar Torx Key
		Inter Cooland	D	Z	L1	L	d			
ZCC VCGX 1103										
ST VCGX 11 001 ZCC	✓	✓	16	2	50	60	16	VCGX 1103	M2.5x6	T08
ST VCGX 11 002 ZCC	✓	✓	17	2	30	220	16			
ST VCGX 11 003 ZCC	✓	✓	20	3	50	160	20			
ST VCGX 11 004 ZCC	✓	✓	21	3	30	220	20			
ST VCGX 11 005 ZCC	✓	✓	25	3	50	160	25			
ST VCGX 11 006 ZCC	✓	✓	26	3	30	220	26			

ADMT 1204 WLTR

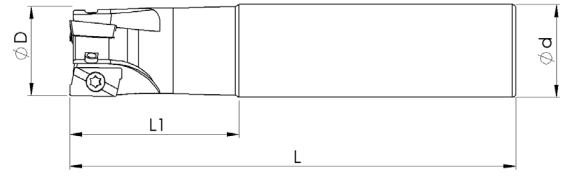

Kesici Uç Uyumluluğu Insert Suitability	Stok / Stock		Takım Ölçüleri / Dimension (mm)					Uç İnsert	Vida Screw	Anahtar Torx Key
	WLTR ADMT 1204	Inter Cooland	D	Z	L1	L	d			
ST ADMT 12 001 WLTR	✓	✓	20	2	40	120	20	ADMT..1204	M3X9	T10
ST ADMT 12 002 WLTR	✓	✗	20	2	50	150	20			
ST ADMT 12 003 WLTR	✓	✓	25	3	40	120	25			
ST ADMT 12 004 WLTR	✓	✗	25	3	50	150	25			
ST ADMT 12 005 WLTR	✓	✗	30	3	30	120	25			
ST ADMT 12 006 WLTR	✓	✗	30	3	30	150	25			
ST ADMT 12 007 WLTR	✓	✓	32	4	50	150	32			
ST ADMT 12 008 WLTR	✓	✗	40	4	40	120	32			
ST ADMT 12 009 WLTR	✓	✗	40	4	40	150	32			

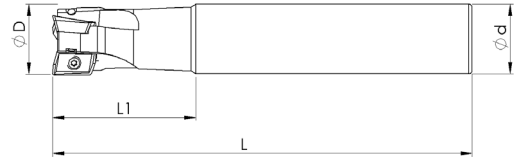

ADMT 10T3 WLTR



Kesici Uç Uyumluluğu Insert Suitability	Stok / Stock		Takım Ölçüleri / Dimension (mm)					Uç İnsert	Vida Screw	Anahtar Torx Key
	WLTR ADMT 10T3..	Inter Cooland	D	Z	L1	L	d			
ST ADMT 10 001 WLTR	✗	✗	16	2	35	90	16	ADMT 10T3..	M2.5X6	T08
ST ADMT 10 002 WLTR	✓	✗	20	3	40	120	20			
ST ADMT 10 003 WLTR	✓	✗	25	3	40	120	25			

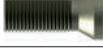

ADMT 0803 WLTR

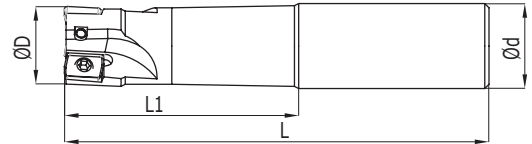

Kesici Uç Uyumluluğu Insert Suitability	Stok / Stock		Takım Ölçüleri / Dimension (mm)					Uç İnsert	Vida Screw	Anahtar Torx Key
		Inter Cooland	D	Z	L1	L	d			
WLTR ADMT 0803										
ST ADMT 08 001 WLTR	✓	✓	16	2	50	150	16	ADMT 0803	M2.5x6	T08
ST ADMT 08 002 WLTR	✓	✗	20	2	30	200	16			
ST ADMT 08 003 WLTR	✓	✓	20	3	50	150	20			
ST ADMT 08 004 WLTR	✓	✗	20	3	60	200	20			
ST ADMT 08 005 WLTR	✓	✗	26	3	30	150	25			
ST ADMT 08 006 WLTR	✓	✗	26	3	30	200	25			

AP..0903 WLTR



Kesici Uç Uyumluluğu Insert Suitability	Stok / Stock		Takım Ölçüleri / Dimension (mm)					Uç İnsert	Vida Screw	Anahtar Torx Key
		Inter Cooland	D	Z	L1	L	d			
WLTR AP..0903										
ST AP..09 001 WLTR	✓	✗	16	2	35	100	16	AP..0903..	M2.5X6	T08
ST AP..09 002 WLTR	✓	✗	16	2	40	130	16			
ST AP..09 003 WLTR	✓	✗	16	2	50	150	16			
ST AP..09 004 WLTR	✓	✗	16	2	60	200	16			
ST AP..09 005 WLTR	✓	✗	20	3	40	120	20			
ST AP..09 006 WLTR	✓	✗	20	3	50	150	20			
ST AP..09 007 WLTR	✓	✗	20	3	60	200	20			

LNHU 0904 WLTR

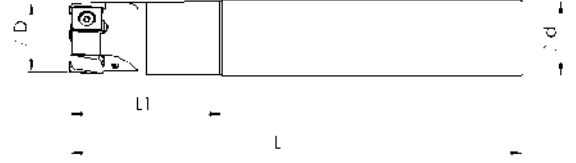

Kesici Uç Uyumluluğu Insert Suitability	Stok / Stock		Takım Ölçüleri / Dimension (mm)					Uç Insert	Vida Screw	Anahtar Torx Key
		Inter Cooland	D	Z	L1	L	d			
WLTR LNHU 0904										
ST LNHU 09 001 WLTR	✓	✓	20	3	40	120	20	LNHU 0904	M3X10	T10
ST LNHU 09 002 WLTR	✓	✓	20	3	50	150	20			
ST LNHU 09 003 WLTR	✓	✓	25	4	40	120	25			
ST LNHU 09 004 WLTR	✓	✓	25	4	50	150	25			
ST LNHU 09 005 WLTR	✓	✓	32	5	40	120	32			

LPGT 0702 WLTR

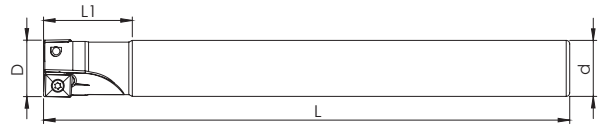

Kesici Uç Uyumluluğu Insert Suitability	Stok / Stock		Takım Ölçüleri / Dimension (mm)					Uç Insert	Vida Screw	Anahtar Torx Key
		Inter Cooland	D	Z	L1	L	d			
WLTR LPGT 0702										
ST LPGT 0702 001 WLTR	✓	X	17	2	30	150	16	LPGT 0702..	M2,5X6	T08
ST LPGT 0702 002 WLTR	✓	X	21	3	30	150	20			
ST LPGT 0702 003 WLTR	✓	X	26	4	30	150	25			

LNHU 1306 WLTR

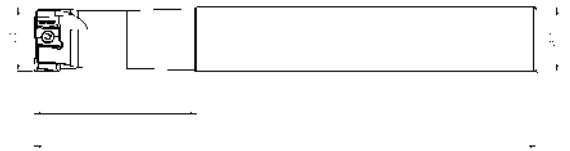

Kesici Uç Uyumluluğu Insert Suitability	Stok / Stock		Takım Ölçüleri / Dimension (mm)					Uç Insert	Vida Screw	Anahtar Torx Key
		Inter Cooland	D	Z	L1	L	d			
WLTR LNHU 1306										
ST LNHU 13 001 WLTR	✓	✓	30	3	40	150	25	LNHU 1306	M4X9	T15
ST LNHU 13 002 WLTR	✓	✓	32	3	70	250	32			
ST LNHU 13 003 WLTR	✓	✓	40	4	40	150	32			
ST LNHU 13 004 WLTR	✓	✓	40	4	60	200	40			

AXMT 1235 SMTM

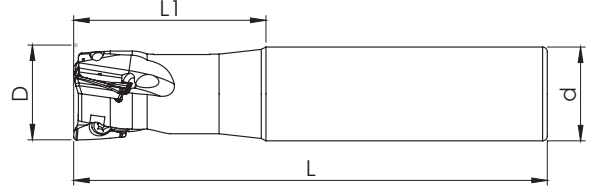

Kesici Uç Uyumluluğu Insert Suitability	Stok / Stock		Takım Ölçüleri / Dimension (mm)					Uç Insert	Vida Screw	Anahtar Torx Key
		Inter Cooland	D	Z	L1	L	d			
SMTM AXMT 1235										
ST AXMT 1235 001 SMTM	X	X	12	1	30	100	12	AXMT 1235..	M3X6	T10
ST AXMT 1235 002 SMTM	X	X	14	1	30	100	12			
ST AXMT 1235 003 SMTM	X	X	16	1	30	100	16			
ST AXMT 1235 004 SMTM	X	X	18	2	30	100	16			
ST AXMT 1235 005 SMTM	X	X	20	3	35	100	20			

AXMT 0602 SMTM

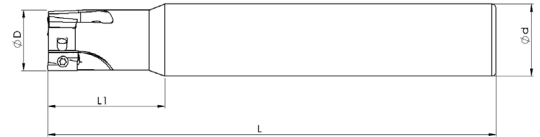

Kesici Uç Uyumluluğu Insert Suitability	Stok / Stock		Takım Ölçüleri / Dimension (mm)					Uç Insert	Vida Screw	Anahtar Torx Key
		Inter Cooland	D	Z	L1	L	d			
SMTM AXMT 0602										
ST AXMT 06 001 SMTM	✓	X	10	2	15	75	10	AXMT 0602..	M1,8X4,2	T06
ST AXMT 06 002 SMTM	✓	X	12	2	20	120	12			
ST AXMT 06 003 SMTM	✓	X	12	3	20	90	12			
ST AXMT 06 004 SMTM	✓	X	14	3	30	100	16			

APKT 1003 PLBT

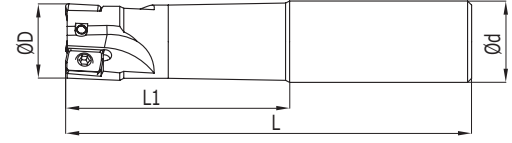

Kesici Uç Uyumluluğu Insert Suitability	Stok / Stock		Takım Ölçüleri / Dimension (mm)					Uç Insert	Vida Screw	Anahtar Torx Key
		Inter Cooland	D	Z	H	L	d			
PLT APKT 1003..										
ST APKT 10 001 PLT	X	X	16	2	40	120	X	APKT 1003..	M2.5x6	T08
ST APKT 10 002 PLT	✓	X	16	2	50	150				
ST APKT 10 003 PLT	X	X	20	3	40	120				
ST APKT 10 004 PLT	✓	X	20	3	50	150				
ST APKT 10 005 PLT	X	X	25	3	40	120				
ST APKT 10 006 PLT	✓	X	25	3	50	150				
								M2.5x7		
								M2.5x8		

XPET 0602 PLBT

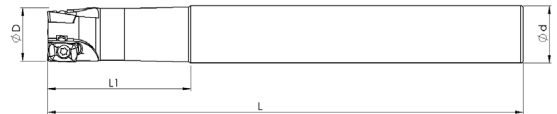

Kesici Uç Uyumluluğu Insert Suitability	Stok / Stock		Takım Ölçüleri / Dimension (mm)					Uç Insert	Vida Screw	Anahtar Torx Key
		Inter Cooland	D	Z	L1	L	d			
PLBT XPET 0602										
ST XPET 06 001 PLBT	✓	X	8	1	22	100	8	XPET..0602	M1,8X4,2	T06
ST XPET 06 002 PLBT	✓	X	8	1	25	120	8			
ST XPET 06 003 PLBT	✓	X	10	2	22	120	9			
ST XPET 06 004 PLBT	✓	X	10	2	22	100	10			
ST XPET 06 006 PLBT	✓	X	12	3	22	100	12			
ST XPET 06 007 PLBT	✓	X	12	3	22	100	11			
ST XPET 06 008 PLBT	✓	X	12	3	22	120	12			
ST XPET 06 009 PLBT	✓	X	14	3	18	140	12			
ST XPET 06 010 PLBT	✓	X	16	4	20	160	12			

LN..0804 I

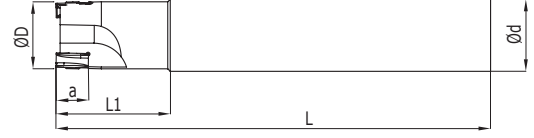
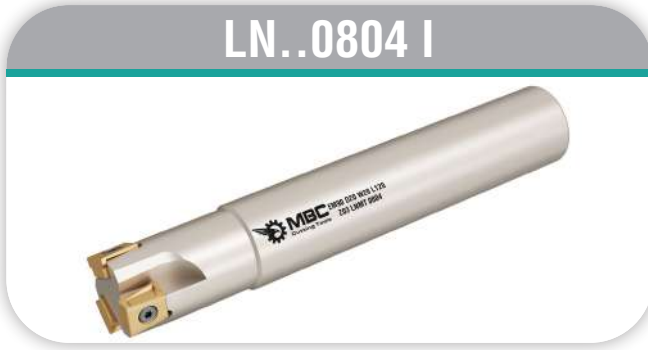

Kesici Uç Uyumluluğu Insert Suitability	Stok / Stock		Takım Ölçüleri / Dimension (mm)					Uç İnsert	Vida Screw	Anahtar Torx Key
		Inter Cooland	D	Z	L1	L	d			
İ LNMT 0804										
ST LN..08 001 I	✓	X	16	2	40	120	16	LN..08	M2.5X6	T08
ST LN..08 002 I	✓	X	18	2	30	120	20			
ST LN..08 003 I	✓	X	20	3	40	120	20			
ST LN..08 004 I	✓	X	25	3	50	150	25		M2.5X7	
ST LN..08 005 I	✓	X	25	4	50	150	25			
ST LN..08 006 I	✓	X	27	4	30	120	25			
ST LN..08 007 I	✓	X	30	4	30	200	25			
ST LN..08 008 I	✓	X	30	4	30	150	25			
ST LN..08 009 I	✓	X	32	4	60	200	32			

AN..1205 I

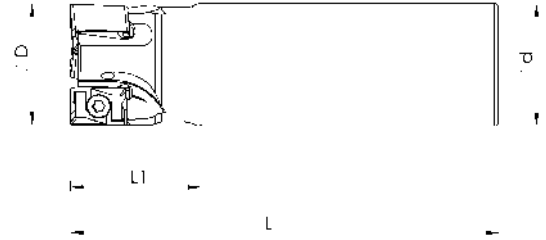

Kesici Uç Uyumluluğu Insert Suitability	Stok / Stock		Takım Ölçüleri / Dimension (mm)					Uç İnsert	Vida Screw	Anahtar Torx Key
		Inter Cooland	D	Z	L1	L	d			
İ ANKX 1205										
ST ANKX 12 001 I	X	X	30	2	30	120	25	AN..1205	M4X11	T15
ST ANKX 12 002 I	X	X	30	2	30	150	25			
ST ANKX 12 003 I	✓	X	30	3	30	120	25			
ST ANKX 12 004 I	✓	X	35	3	40	110	32			
ST ANKX 12 005 I	✓	X	35	3	40	120	32			
ST ANKX 12 006 I	✓	X	35	3	40	150	32			
ST ANKX 12 007 I	X	X	30	3	40	110	30			
ST ANKX 12 008 I	✓	X	32	3	30	200	25			

TP..1003 I

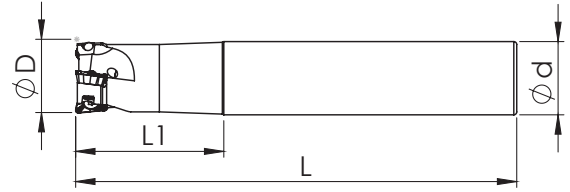

Kesici Uç Uyumluluğu Insert Suitability	Stok / Stock		Takım Ölçüleri / Dimension (mm)					Uç İnsert	Vida Screw	Anahtar Torx Key
		Inter Cooland	D	Z	L1	L	d			
I TPKT 1003										
ST TPKT 10 001 I	✓	✓	25	3	40	120	25	TPKT 1003	M3X8	T10
ST TPKT 10 002 I	✓	✓	25	3	50	150	25			
ST TPKT 10 003 I	X	✓	32	4	40	130	32			
ST TPKT 10 004 I	✓	✓	32	4	50	150	32			
ST TPKT 10 005 I	X	✓	40	5	40	130	32			
ST TPKT 10 006 I	✓	✓	40	5	40	150	32			

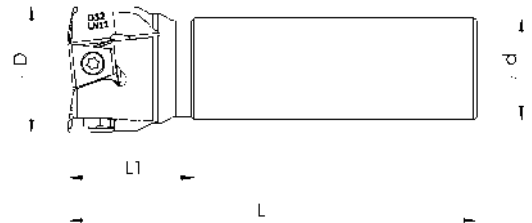

LNHT 1106 I



Kesici Uç Uyumluluğu Insert Suitability	Stok / Stock		Takım Ölçüleri / Dimension (mm)					Uç İnsert	Vida Screw	Anahtar Torx Key
		Inter Cooland	D	Z	L1	L	d			
I LNHT 1106										
ST LNHT 11 001 I	✓	✓	32	3	40	100	25	LNHT 1103	M3X8	T10
ST LNHT 11 002 I	✓	✓	40	4	40	100	32			

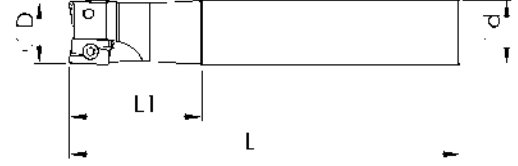

ADKT 1505 I

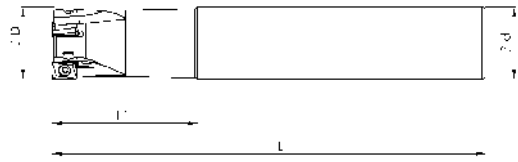

Kesici Uç Uyumluluğu Insert Suitability	Stok / Stock		Takım Ölçüleri / Dimension (mm)					Uç Insert	Vida Screw	Anahtar Torx Key
		Inter Cooland	D	Z	L1	L	d			
I ADKT 1505										
ST ADKT 15 001 I	✓	✓	25	2	50	150	25	ADKT 1505	M4X11	T15
ST ADKT 15 002 I	✓	✓	32	3	50	150	32			
ST ADKT 15 003 I	✓	✓	40	4	40	150	32			

ANKX 0904 I



Kesici Uç Uyumluluğu Insert Suitability	Stok / Stock		Takım Ölçüleri / Dimension (mm)					Uç Insert	Vida Screw	Anahtar Torx Key
		Inter Cooland	D	Z	L1	L	d			
I ANKX 0904										
ST ANKX 09 001 I	✓	✓	16	2	50	150	16	ANKX 0904	M3X8	T10
ST ANKX 09 002 I	✓	✓	20	2	50	150	20			
ST ANKX 09 003 I	✓	✓	25	2	50	150	25			
ST ANKX 09 004 I	✓	✓	20	3	50	150	20			
ST ANKX 09 005 I	✓	✓	25	3	50	150	25			
ST ANKX 09 006 I	✓	✓	32	4	50	150	32			

TCKT 0703 I

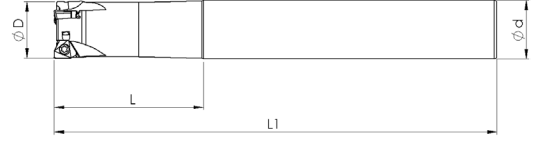

Kesici Uç Uyumluluğu Insert Suitability	Stok / Stock		Takım Ölçüleri / Dimension (mm)					Uç Insert	Vida Screw	Anahtar Torx Key
		Inter Cooland	D	Z	L1	L	d			
I TCKT 0703										
ST TCKT 07 001 I	✓	✓	16	2	50	150	16	TCKT 0703	M2,5X7	T8
ST TCKT 07 002 I	✓	✓	20	2	50	150	20			

LNGU 1104 KNNMTL

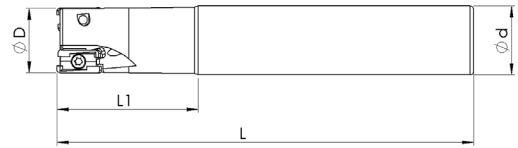

Kesici Uç Uyumluluğu Insert Suitability	Stok / Stock		Takım Ölçüleri / Dimension (mm)					Uç Insert	Vida Screw	Anahtar Torx Key
		Inter Cooland	D	Z	L1	L	d			
KNNMTL LNGU 1104										
ST LNGU 11 001 KNM	✓	✓	12	2	40	120	16	LNGU 1104	M3X8	T10
ST LNGU 11 002 KNM	✓	✓	20	2	40	120	20			
ST LNGU 11 003 KNM	✓	✓	25	3	40	120	25			
ST LNGU 11 004 KNM	✓	✓	25	3	50	150	25			
ST LNGU 11 005 KNM	✓	✓	16	2	50	150	16			
ST LNGU 11 006 KNM	✓	✓	20	2	50	150	20			

EDPT 1404 KNNMTL

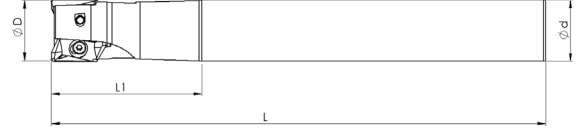

Kesici Uç Uyumluluğu Insert Suitability	Stok / Stock		Takım Ölçüleri / Dimension (mm)					Uç Insert	Vida Screw	Anahtar Torx Key
		Inter Cooland	D	Z	L1	L	d			
KNNMTL EDPT 1404										
ST EDPT 14 001 KNM	✓	X	20	2	40	120	20	EDPT 1404	M3X9	T10
ST EDPT 14 002 KNM	✓	X	20	2	50	150	20			
ST EDPT 14 003 KNM	✓	X	25	3	40	120	25			
ST EDPT 14 004 KNM	✓	X	25	3	50	150	25			

EDPT 10T3/1805 KNNMTL

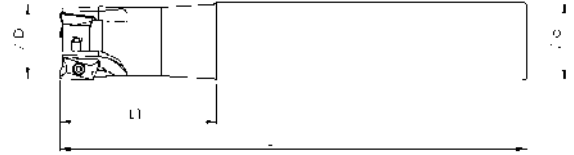

Kesici Uç Uyumluluğu Insert Suitability	Stok / Stock		Takım Ölçüleri / Dimension (mm)					Uç Insert	Vida Screw	Anahtar Torx Key
		Inter Cooland	D	Z	L1	L	d			
KNNMTL EDPT 10T3/1805										
ST EDPT 10 001 KNM	✓	X	16	2	45	150	16	EDPT 10T3	M2,5X6	T8
ST EDPT 10 002 KNM	✓	X	18	2	30	150	16			
ST EDPT 10 003 KNM	✓	X	20	3	50	150	20			
ST EDPT 10 004 KNM	✓	X	25	3	50	150	25			
ST EDPT 10 005 KNM	✓	X	17	2	30	150	16			
ST EDPT 10 006 KNM	✓	X	21	3	50	150	20			
ST EDPT 10 007 KNM	✓	X	16	2	30	120	14			
ST EDPT 10 008 KNM	✓	X	17	2	30	200	16			
ST EDPT 10 009 KNM	✓	X	22	3	30	200	20			
ST EDPT 10 010 KNM	✓	X	16	2	40	120	16			
ST EDPT 10 011 KNM	✓	X	22	3	30	150	20			
ST EDPT 18 005 KNM	✓	X	25	2	50	200	25	EDPT 1805	M3,5X8	T15
ST EDPT 18 006 KNM	✓	X	32	3	50	200	32			

LNMX 1006 KRLY

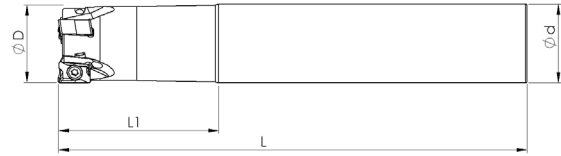

Kesici Uç Uyumluluğu Insert Suitability	Stok / Stock		Takım Ölçüleri / Dimension (mm)					Uç Insert	Vida Screw	Anahtar Torx Key
		Inter Cooland	D	Z	L1	L	d			
KRLY LNMX 1006										
ST LNMX 10 000 KRLY	X	✓	14	1	30	90	16	LNMX 1006	M3X8	T10
ST LNMX 10 001 KRLY	✓	✓	16	1	35	90	16			
ST LNMX 10 002 KRLY	X	✓	18	2	30	90	16			
ST LNMX 10 003 KRLY	✓	✓	18	2	30	120	16			
ST LNMX 10 004 KRLY	X	✓	20	2	30	150	18			
ST LNMX 10 005 KRLY	✓	✓	20	2	35	100	20			
ST LNMX 10 006 KRLY	✓	✓	20	2	50	150	20			
ST LNMX 10 007 KRLY	✓	✓	25	3	30	150	24			
ST LNMX 10 008 KRLY	✓	✓	25	2	35	115	25			
ST LNMX 10 009 KRLY	✓	✓	25	3	35	115	25			
ST LNMX 10 010 KRLY	✓	✓	25	3	50	150	25			
ST LNMX 10 011 KRLY	✓	✓	32	3	40	125	32			
ST LNMX 10 012 KRLY	✓	✓	32	4	40	125	32			
ST LNMX 10 013 KRLY	✓	✓	40	4	40	130	32			
ST LNMX 10 014 KRLY	✓	✓	40	5	40	130	32			
ST LNMX 10 015 KRLY	✓	✓	50	5	40	135	32			
ST LNMX 10 016 KRLY	✓	✓	32	4	60	200	32			
ST LNMX 10 017 KRLY	✓	✓	26	3	30	200	25			
ST LNMX 10 018 KRLY	✓	✓	32	4	50	150	32			

XNKT 0604 KRLY

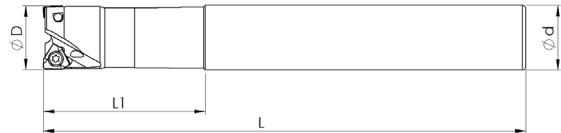

Kesici Uç Uyumluluğu Insert Suitability	Stok / Stock		Takım Ölçüleri / Dimension (mm)					Uç Insert	Vida Screw	Anahtar Torx Key			
		Inter Cooland	D	Z	L1	L	d						
KRLY XNKT 0604/0805													
ST XNKT 06 001 KRLY	✓	✓	18	2	30	150	20	XNKT 0604	M3X8	T10			
ST XNKT 06 002 KRLY	✓	✓	20	2	30	150	20						
ST XNKT 06 003 KRLY	✓	✓	22	2	30	150	20						
ST XNKT 06 004 KRLY	✓	✓	25	3	50	150	25						
ST XNKT 06 005 KRLY	✓	✓	26	4	30	150	25						
ST XNKT 06 006 KRLY	✓	✓	32	4	50	150	32						
ST XNKT 06 007 KRLY	✓	✓	32	3	50	150	32						
ST XNKT 06 010 KRLY	✓	✓	25	3	60	200	25						
ST XNKT 06 011 KRLY	✓	✓	26	3	30	200	25						
ST XNKT 06 012 KRLY	✓	✓	21	2	30	150	20						
ST XNKT 08 008 KRLY	✓	✓	32	3	50	150	32				XNKT 0808	M4X10	T15
ST XNKT 08 009 KRLY	✓	✓	42	4	35	150	32						
ST XNKT 08 010 KRLY	✓	✓	32	3	60	200	32						
ST XNKT 08 011 KRLY	✓	✓	32	3	70	250	32						
ST XNKT 08 012 KRLY	✓	✓	40	4	40	200	32						
ST XNKT 08 013 KRLY	✓	✓	40	4	40	250	32						

APMT 11T308 KRLY

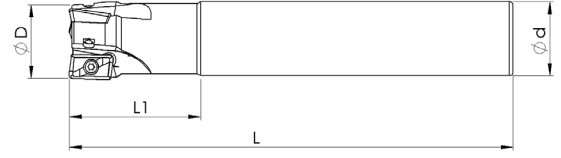

Kesici Uç Uyumluluğu Insert Suitability	Stok / Stock		Takım Ölçüleri / Dimension (mm)					Uç Insert	Vida Screw	Anahtar Torx Key
		Inter Cooland	D	Z	L1	L	d			
KRLY APMT 11T3										
ST APMT 11 001 KRLY	✓	X	16	2	40	120	16	APMT 11T308	M2,5X6	T8
ST APMT 11 002 KRLY	✓	X	16	2	50	150	16			
ST APMT 11 003 KRLY	✓	X	16	2	60	200	16			
ST APMT 11 004 KRLY	✓	X	17	2	30	120	16			
ST APMT 11 005 KRLY	✓	X	20	3	40	120	20			
ST APMT 11 006 KRLY	✓	X	21	3	30	120	20			
ST APMT 11 007 KRLY	✓	X	22	3	30	120	20			
ST APMT 11 008 KRLY	✓	X	20	3	60	200	20			
ST APMT 11 009 KRLY	✓	X	21	3	30	200	20			
ST APMT 11 010 KRLY	✓	X	25	3	50	150	25			
ST APMT 11 011 KRLY	✓	X	18	2	30	120	16			
ST APMT 11 012 KRLY	✓	X	20	3	50	150	20			
ST APMT 11 013 KRLY	✓	X	17	2	30	150	16			
ST APMT 11 014 KRLY	✓	X	21	3	30	150	20			
ST APMT 11 015 KRLY	✓	X	22	3	30	150	20			

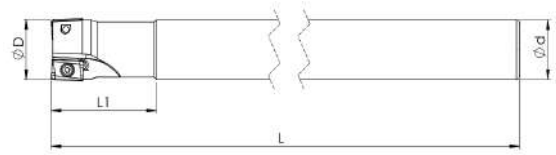

ST APKT 1003 YG



Kesici Uç Uyumluluğu Insert Suitability	Stok / Stock		Takım Ölçüleri / Dimension (mm)					Uç Insert	Vida Screw	Anahtar Torx Key
		Inter Cooland	D	Z	L1	L	d			
YG APKT 1003										
ST APKT 10 001 YG	✓	X	17	2	30	200	16	APKT 1003	M2,5X7	T8
ST APKT 10 002 YG	✓	X	17	2	30	300	16			
ST APKT 10 003 YG	✓	X	21	2	35	200	20			
ST APKT 10 004 YG	✓	X	21	2	35	300	20			

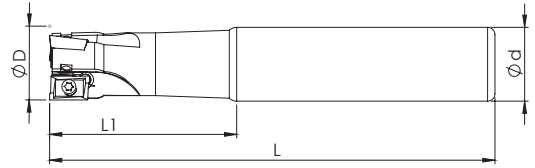

R390 11T3 SNDVK



Kesici Uç Uyumluluğu Insert Suitability	Stok / Stock		Takım Ölçüleri / Dimension (mm)					Uç Insert	Vida Screw	Anahtar Torx Key
		Inter Cooland	D	Z	L1	L	d			
SNDVK R390-11T3										
ST R390 11 001 SNDVK	✓	✓	16	2	44	150	16	R390-11T3	M2,5X6	T8
ST R390 11 002 SNDVK	✓	✓	20	3	50	150	20			
ST R390 11 003 SNDVK	✓	✓	25	3	50	150	25			
ST R390 11 004 SNDVK	✓	X	20	3	40	100	20			
ST R390 11 005 SNDVK	✓	X	16	2	35	100	16			
ST R390 11 006 SNDVK	✓	X	25	3	35	100	25			

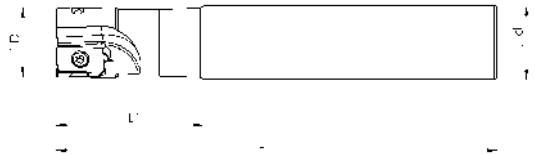

R390 1704 SNDVK



Kesici Uç Uyumluluğu Insert Suitability	Stok / Stock		Takım Ölçüleri / Dimension (mm)					Uç Insert	Vida Screw	Anahtar Torx Key
		Inter Cooland	D	Z	L1	L	d			
SNDVK R390-1704										
ST R390 17 001 SNDVK	✓	✓	25	2	50	150	25	R390 1704	M3,5X11	T15
ST R390 17 002 SNDVK	✓	✓	32	3	50	150	32			
ST R390 17 003 SNDVK	✓	X	40	4	40	150	25			

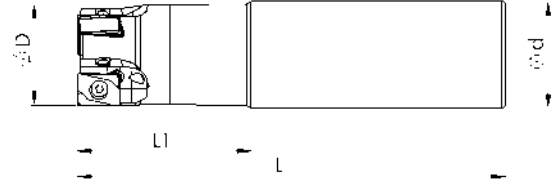

ANHG 1005 VNDRT

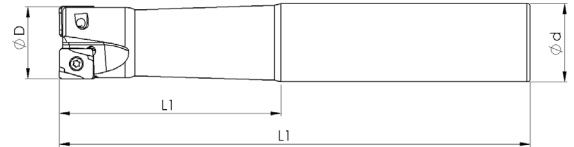

Kesici Uç Uyumluluğu Insert Suitability	Stok / Stock		Takım Ölçüleri / Dimension (mm)					Uç Insert	Vida Screw	Anahtar Torx Key
		Inter Cooland	D	Z	L1	L	d			
VNDRT ANHG 1005										
ST ANHG 10 001 VNDRT	✓	✓	20	2	35	90	20	ANHG 1005	M3X10	T10
ST ANHG 10 002 VNDRT	✓	✓	20	2	40	120	20			
ST ANHG 10 003 VNDRT	✓	✓	20	2	50	150	20			
ST ANHG 10 004 VNDRT	✓	✓	25	3	35	100	25			
ST ANHG 10 005 VNDRT	✓	✓	25	3	50	150	25			
ST ANHG 10 006 VNDRT	✓	✓	32	3	35	110	32			

LNGX 1205 PRMT/VNDRT



Kesici Uç Uyumluluğu Insert Suitability	Stok / Stock		Takım Ölçüleri / Dimension (mm)					Uç Insert	Vida Screw	Anahtar Torx Key
		Inter Cooland	D	Z	H	L	d			
PRMT/VNDRT LNGX 1205										
ST LNGX 12 001 VNDRT	✓	X	25	3	50	150	25	LNGX 1205	M3,5X10	T15
ST LNGX 12 002 VNDRT	✓	X	32	3	50	150	32			

TNGX 1004 PRMT



Kesici Uç Uyumluluğu Insert Suitability	Stok / Stock		Takım Ölçüleri / Dimension (mm)					Uç Insert	Vida Screw	Anahtar Torx Key
		Inter Cooland	D	Z	L1	L	d			
PRMT TNGX 1004										
ST TNGX 10 001 PRMT	✓	✓	18	2	30	150	16	TNGX 1004	M2,5X7	T8
ST TNGX 10 002 PRMT	✓	✓	21	3	30	150	20			
ST TNGX 10 003 PRMT	✓	✓	26	4	30	150	25			
ST TNGX 10 004 PRMT	✓	✓	26	4	30	200	25			
ST TNGX 10 005 PRMT	✓	✓	33	5	40	150	32			
ST TNGX 10 006 PRMT	✓	✓	33	5	40	200	32			

ADMX 11T3 PRMT

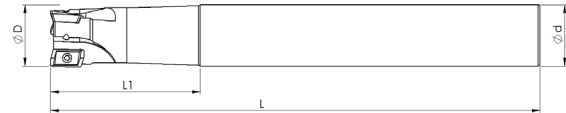

Kesici Uç Uyumluluğu Insert Suitability	Stok / Stock		Takım Ölçüleri / Dimension (mm)					Uç Insert	Vida Screw	Anahtar Torx Key
		Inter Cooland	D	Z	H	L	d			
PRMT ADMX 11T3										
ST ADMX 11 001 PRMT	✓	X	12	1	40	120	12	ADMX 11T3..	M2,5X5	T08
ST ADMX 11 002 PRMT	✓	✓	16	2	50	150	16		M2,5X6	
ST ADMX 11 003 PRMT	✓	✓	20	3	50	150	20		M2,5X7	
ST ADMX 11 004 PRMT	✓	X	25	3	60	200	25			
ST ADMX 11 005 PRMT	✓	X	32	4	60	200	32			
ST ADMX 11 006 PRMT	✓	✓	25	4	60	200	25			

AXMT 0602 TT

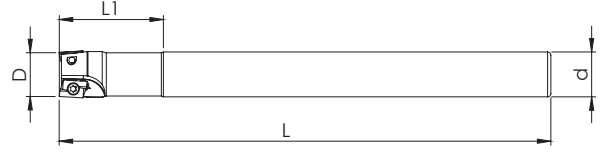

Kesici Uç Uyumluluğu Insert Suitability	Stok / Stock		Takım Ölçüleri / Dimension (mm)					Uç İnsert	Vida Screw	Anahtar Torx Key
		Inter Cooland	D	Z	L1	L	d			
TT AXMT 0602										
ST AXMT 06 001 TT	✓	✗	10	2	120	150	9	AXMT 0602	M1,8X4,2	T6
ST AXMT 06 002 TT	✓	✗	11	2	120	150	10			
ST AXMT 06 003 TT	✓	✗	12	2	120	150	11			

4NKT 0402 TT



Kesici Uç Uyumluluğu Insert Suitability	Stok / Stock		Takım Ölçüleri / Dimension (mm)					Uç İnsert	Vida Screw	Anahtar Torx Key
		Inter Cooland	D	Z	L1	L	d			
TT AXMT 0602										
ST 4NKT 04 001 TT	✓	✗	10	2	30	100	10	4NKT 0402	M1,8X4,2	T6
ST 4NKT 04 002 TT	✓	✗	12	3	35	120	12			
ST 4NKT 04 003 TT	✓	✗	16	4	40	150	16			

4NKT 0603 TT

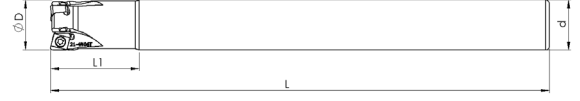

Kesici Uç Uyumluluğu Insert Suitability	Stok / Stock		Takım Ölçüleri / Dimension (mm)					Uç Insert	Vida Screw	Anahtar Torx Key
		Inter Cooland	D	Z	L1	L	d			
TT 4NKT 0603										
ST 4NKT 06 001 TT	✓	X	16	2	40	120	16	4NKT 0603	M3X8	T10
ST 4NKT 06 002 TT	✓	✓	16	2	50	150	16			
ST 4NKT 06 003 TT	✓	✓	17	2	30	150	16			
ST 4NKT 06 004 TT	✓	✓	17	2	30	200	16			
ST 4NKT 06 005 TT	✓	✓	20	3	50	160	20			
ST 4NKT 06 006 TT	✓	✓	21	3	30	200	20			
ST 4NKT 06 007 TT	✓	✓	25	3	60	200	25			
ST 4NKT 06 008 TT	✓	✓	26	3	30	200	25			
ST 4NKT 06 009 TT	✓	X	25	3	40	120	25			
ST 4NKT 06 010 TT	✓	✓	20	3	40	120	20			
ST 4NKT 06 011 TT	✓	X	20	2	40	160	20			
ST 4NKT 06 012 TT	✓	✓	25	3	40	150	25			
ST 4NKT 06 013 TT	✓	✓	25	4	40	150	25			
ST 4NKT 06 015 TT	✓	✓	18	2	30	150	16			
ST 4NKT 06 016 TT	✓	✓	22	3	30	160	20			
ST 4NKT 06 021 TT	✓	✓	21	3	30	160	20			

6NGU 0604 TT

NEW



Kesici Uç Uyumluluğu Insert Suitability	Stok / Stock		Takım Ölçüleri / Dimension (mm)					Uç Insert	Vida Screw	Anahtar Torx Key
		Inter Cooland	D	Z	L1	L	d			
TT AXMT 0602										
ST 6NGU 06 005 TT	✓	✓	25	2	50	150	25	6NGU 0604	M3X8	T10
ST 6NGU 06 004 TT	✓	✓	32	3	50	150	32			

2PKT 0503 TT

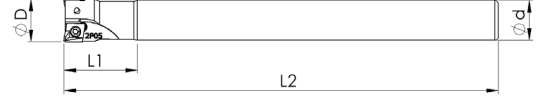

Kesici Uç Uyumluluğu Insert Suitability	Stok / Stock		Takım Ölçüleri / Dimension (mm)					Uç Insert	Vida Screw	Anahtar Torx Key
		Inter Cooland	D	Z	L1	L	d			
TT 2PKT 0503										
ST 2PKT 05 001 TT	✓	X	12	2	20	120	11	2PKT 0503	M2X5	T6
ST 2PKT 05 002 TT	✓	X	12	2	30	120	12			
ST 2PKT 05 003 TT	✓	X	16	3	40	120	16			

3PKT 1004 TT

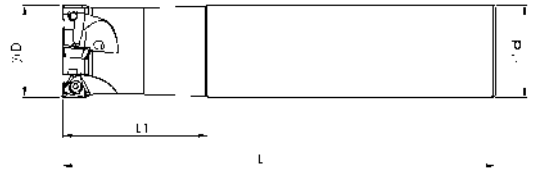

Kesici Uç Uyumluluğu Insert Suitability	Stok / Stock		Takım Ölçüleri / Dimension (mm)					Uç Insert	Vida Screw	Anahtar Torx Key
		Inter Cooland	D	Z	L1	L	d			
TT 3PKT 1004										
ST 3PKT 1004 001 TT	✓	✓	20	2	50	150	20	3PKT 1004	M2,5X7	T8
ST 3PKT 1004 002 TT	✓	✓	25	3	50	150	25			
ST 3PKT 1004 003 TT	✓	✓	32	4	50	150	32			

3PKT 1505 TT



NEW



Kesici Uç Uyumluluğu Insert Suitability	Stok / Stock		Takım Ölçüleri / Dimension (mm)					Uç Insert	Vida Screw	Anahtar Torx Key
		Inter Cooland	D	Z	L1	L	d			
TT 3PKT 1505										
ST 3PKT 15 001 TT	✓	✓	32	3	30	150	25	3PKT 1505	M4,5X12	T20
ST 3PKT 15 003 TT	✓	✓	32	3	60	200	32			

Lütfen Sipariş vermeden önce stok durumunu sorunuz.
Please ask before ordering, stock status.

L: Sol / Left



R: Sağ / Right

✓ Stokta / In Stock

X Stokta Yok / Non Stock

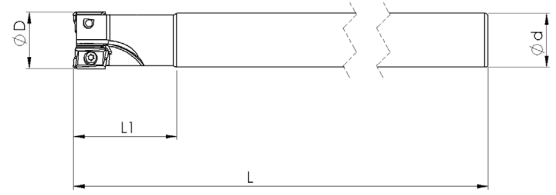

APKT 09T3 TT

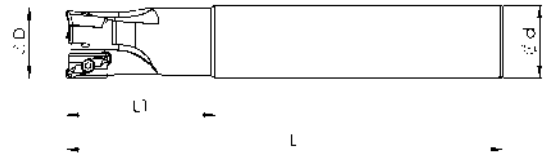

Kesici Uç Uyumluluğu Insert Suitability	Stok / Stock		Takım Ölçüleri / Dimension (mm)					Uç İnsert	Vida Screw	Anahtar Torx Key
		Inter Cooland	D	Z	L1	L	d			
TT APKT 09T3										
ST APKT 09 001 TT	✓	X	16	2	30	150	15	APKT 09T3	M2,5X7	T8
ST APKT 09 002 TT	✓	X	17	2	30	200	16			
ST APKT 09 003 TT	✓	X	21	3	30	200	20			

BDMT 1103 WDA



Kesici Uç Uyumluluğu Insert Suitability	Stok / Stock		Takım Ölçüleri / Dimension (mm)					Uç İnsert	Vida Screw	Anahtar Torx Key
		Inter Cooland	D	Z	L1	L	d			
WDA BDMT 1103										
ST BDMT 11 002 WDA	X	X	16	2	50	150	16	BDMT 1103	M2,5X6	T8
ST BDMT 11 003 WDA	X	X	20	3	40	120	20		M2,5X7	
ST BDMT 11 004 WDA	X	X	20	3	50	150	20		M2,5X8	
ST BDMT 11 005 WDA	X	X	25	3	40	120	25			

XDPT 1104 WDA

NEW



Kesici Uç Uyumluluğu Insert Suitability	Stok / Stock		Takım Ölçüleri / Dimension (mm)					Uç İnsert	Vida Screw	Anahtar Torx Key
	WDA XDPT 1104	Inter Cooland	D	Z	L1	L	d			
ST XDPT 11 001 WDA	✓	✓	18	2	35	170	16	XDPT 1104	M2,5X6	T8
ST XDPT 11 002 WDA	✓	✓	20	3	50	170	20			
ST XDPT 11 003 WDA	✓	✓	25	3	50	170	25			
ST XDPT 11 004 WDA	✓	✓	22	3	35	170	20			
ST XDPT 11 005 WDA	✓	✓	40	5	35	170	32			
ST XDPT 11 007 WDA	✓	✓	45	4	40	120	25			

XNGU 1002 WDA

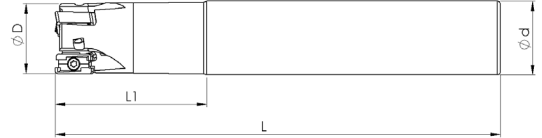



Kesici Uç Uyumluluğu Insert Suitability	Stok / Stock		Takım Ölçüleri / Dimension (mm)					Uç İnsert	Vida Screw	Anahtar Torx Key
	WDA XNGU 1002	Inter Cooland	D	Z	L1	L	d			
ST XNGU 10 001 WDA	✓	✓	16	2	50	150	16	XNGU 1002	M3X8	T10
ST XNGU 10 002 WDA	✓	✓	20	2	50	150	20			
ST XNGU 10 003 WDA	✓	✓	25	3	50	150	25			

BOMT 09T308 INGRSL

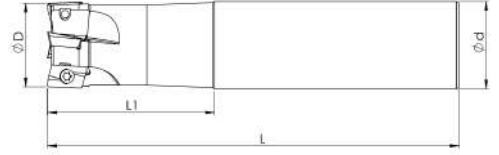

NEW

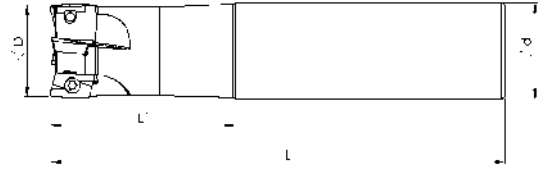

Kesici Uç Uyumluluğu Insert Suitability	Stok / Stock		Takım Ölçüleri / Dimension (mm)					Uç İnsert	Vida Screw	Anahtar Torx Key
		Inter Cooland	D	Z	L1	L	d			
INGRSL BOMT 09T308										
ST BOMT 09 001 INGRSL	✓	X	16	2	40	150	16	BOMT 09T308	M2,5X7	T8
ST BOMT 09 002 INGRSL	✓	X	18	2	40	150	16			
ST BOMT 09 003 INGRSL	✓	X	20	3	40	150	20			
ST BOMT 09 004 INGRSL	✓	X	22	3	40	150	20			

BOMT 1304 INGRSL



Kesici Uç Uyumluluğu Insert Suitability	Stok / Stock		Takım Ölçüleri / Dimension (mm)					Uç İnsert	Vida Screw	Anahtar Torx Key
		Inter Cooland	D	Z	L1	L	d			
INGRSL BOMT 1304										
ST BOMT 13 001 INGRSL	✓	X	20	2	50	150	20	BOMT 1304	M3,5X8	T15
ST BOMT 13 002 INGRSL	✓	X	22	2	30	150	20			
ST BOMT 13 003 INGRSL	✓	X	25	3	50	150	25			
ST BOMT 13 004 INGRSL	✓	X	32	4	30	150	25			
ST BOMT 13 005 INGRSL	✓	X	32	4	50	150	32			

AOMT 1605 INGRSL

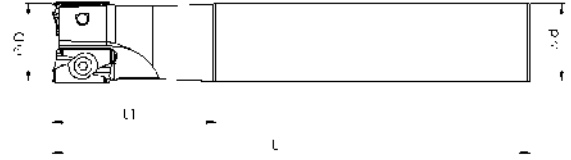

Kesici Uç Uyumluluğu Insert Suitability	Stok / Stock		Takım Ölçüleri / Dimension (mm)					Uç Insert	Vida Screw	Anahtar Torx Key
		Inter Cooland	D	Z	L1	L	d			
INGRSL AOMT 1605										
ST AOMT 16 001 INGRSL	✓	X	25	2	40	120	25	AOMT 1605	M4X9	T15
ST AOMT 16 002 INGRSL	✓	X	25	2	50	150	25			
ST AOMT 16 003 INGRSL	✓	X	25	2	60	200	25			
ST AOMT 16 004 INGRSL	✓	X	32	3	40	150	25			
ST AOMT 16 005 INGRSL	✓	X	32	3	50	150	32			

TOMT 0603/1004 TNGLY

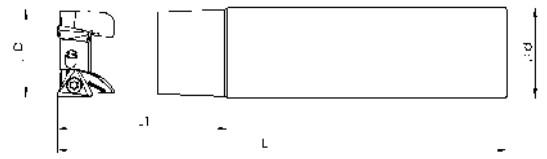

Kesici Uç Uyumluluğu Insert Suitability	Stok / Stock		Takım Ölçüleri / Dimension (mm)					Uç Insert	Vida Screw	Anahtar Torx Key
		Inter Cooland	D	Z	L1	L	d			
TNGLY TOMT 0603/1004										
ST TOMT 06 001 TNG	✓	✓	16	2	50	150	16	TOMT 0603	M2,5X6	T8
ST TOMT 06 002 TNG	X	✓	18	2	30	150	16			
ST TOMT 06 003 TNG	✓	✓	20	3	50	150	20			
ST TOMT 10 004 TNG	X	✓	25	2	50	160	25	TOMT 1004	M3,5X8	T15
ST TOMT 10 005 TNG	X	✓	32	3	50	160	32			

BDMT 0703 KYCR



Kesici Uç Uyumluluğu Insert Suitability	Stok / Stock		Takım Ölçüleri / Dimension (mm)					Uç Insert	Vida Screw	Anahtar Torx Key
		Inter Cooland	D	Z	L1	L	d			
KYCR BDMT 0703										
ST BDMT 07 001 KYCR	✓	X	10	1	20	100	10	BDMT 0703	M2X5	T6
ST BDMT 07 002 KYCR	✓	X	11	2	25	120	10			
ST BDMT 07 003 KYCR	✓	X	12	2	25	120	11			
ST BDMT 07 004 KYCR	✓	X	12	2	30	120	12			
ST BDMT 07 005 KYCR	✓	X	16	3	40	120	16			
ST BDMT 07 006 KYCR	✓	X	14	3	25	120	12		M2X6	

BDMT 1704 KYCR

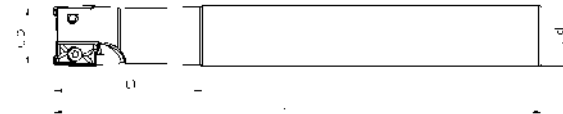

Kesici Uç Uyumluluğu Insert Suitability	Stok / Stock		Takım Ölçüleri / Dimension (mm)					Uç Insert	Vida Screw	Anahtar Torx Key
		Inter Cooland	D	Z	L1	L	d			
KYCR BDMT 1704										
ST BDMT 17 001 KYCR	✓	✓	25	2	50	160	25	BDMT 1704	M4X8	T15
ST BDMT 17 002 KYCR	✓	✓	25	2	60	200	25			
ST BDMT 17 003 KYCR	✓	✓	32	3	60	200	32			
ST BDMT 17 004 KYCR	✓	X	32	3	70	260	32			
ST BDMT 17 005 KYCR	✓	X	33	3	70	250	32			
ST BDMT 17 006 KYCR	✓	X	33	3	40	300	32			

APKT 1003 KYCR

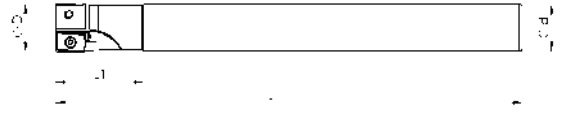

Kesici Uç Uyumluluğu Insert Suitability	Stok / Stock		Takım Ölçüleri / Dimension (mm)					Uç Insert	Vida Screw	Anahtar Torx Key
		Inter Cooland	D	Z	L1	L	d			
KYCR APKT 1003	✓	✓	17	2	30	160	16	APKT 1003	M2.5X6	T8
	✓	✓	21	3	30	160	20			
	✓	✓	25	3	50	160	25			
	✓	✓	25	4	50	160	25			

BDMT 11T3 KYCR

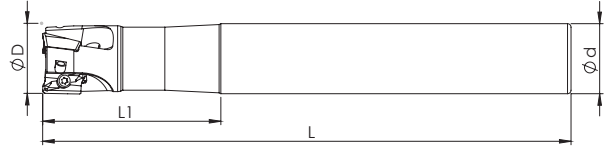

Kesici Uç Uyumluluğu Insert Suitability	Stok / Stock		Takım Ölçüleri / Dimension (mm)					Uç Insert	Vida Screw	Anahtar Torx Key
		Inter Cooland	D	Z	L1	L	d			
KYCR BDMT 11T3	✓	✓	16	2	50	160	16	BDMT 11T3	M2.5X6	T8
	✓	✓	16	2	50	180	16			
	✓	✓	17	2	30	160	16			
	✓	✓	17	2	30	200	16			
	✓	X	17	2	30	260	16			
	✓	✓	20	3	35	110	20			
	✓	✓	20	3	50	160	20			
	✓	✓	20	3	50	180	20			
	✓	✓	20	3	60	200	20			
	✓	✓	21	3	30	160	20			
	✓	✓	21	3	30	180	20			
	✓	✓	21	3	30	200	20			
	✓	X	21	3	30	260	20			
	✓	✓	25	3	50	160	25			
	✓	✓	25	3	60	200	25			
	✓	✓	26	4	30	160	25			
	✓	✓	26	3	30	200	25			
	✓	X	26	3	30	260	25			
	✓	X	32	3	40	300	30			
	✓	✓	32	4	60	200	32			
	✓	X	32	4	70	260	32			
	✓	X	32	4	70	300	32			
	✓	✓	33	4	40	200	32			
	✓	X	33	4	40	260	32			
	✓	✓	16	2	30	160	15			
	✓	✓	18	2	30	160	16			
	✓	✓	17	2	30	170	16			
	✓	✓	20	3	30	120	20			
	✓	✓	33	4	30	150	32			

LOMU 1505 KYCR

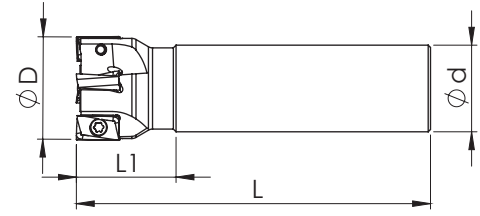

Kesici Uç Uyumluluğu Insert Suitability	Stok / Stock		Takım Ölçüleri / Dimension (mm)					Uç Insert	Vida Screw	Anahtar Torx Key
		Inter Cooland	D	Z	L1	L	d			
KYCR LOMU 1505										
ST LOMU 15 001 KYCR	✓	✓	28	2	30	130	25	LOMU 1505	M4X8	T15
ST LOMU 15 002 KYCR	✓	✓	28	2	30	210	25			
ST LOMU 15 003 KYCR	✓	✓	30	2	30	130	25			
ST LOMU 15 004 KYCR	✓	✓	32	2	40	130	32			
ST LOMU 15 005 KYCR	✓	✓	35	3	40	130	32			
ST LOMU 15 006 KYCR	✓	✓	35	3	40	180	32			
ST LOMU 15 007 KYCR	✓	✓	39	4	40	130	32			
ST LOMU 15 008 KYCR	✓	✓	28	2	30	160	25			
ST LOMU 15 009 KYCR	✓	✓	32	3	30	160	25			
ST LOMU 15 010 KYCR	✓	✓	32	3	50	160	32			

WNMU 0504 KYCR

NEW

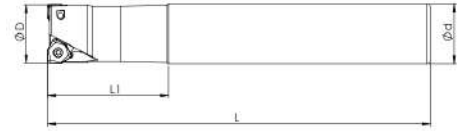

Kesici Uç Uyumluluğu Insert Suitability	Stok / Stock		Takım Ölçüleri / Dimension (mm)					Uç Insert	Vida Screw	Anahtar Torx Key
		Inter Cooland	D	Z	L1	L	d			
KYCR WNMU 0504										
ST WNMU 05 001 KYCR	✓	✓	22	2	30	160	20	WNMU 0504	M3X8	T10
ST WNMU 05 002 KYCR	✓	✓	25	2	35	120	25			
ST WNMU 05 003 KYCR	✓	✓	25	2	50	160	25			
ST WNMU 05 004 KYCR	✓	✓	26	2	35	160	25			
ST WNMU 05 005 KYCR	X	✓	32	3	40	120	32			
ST WNMU 05 006 KYCR	✓	✓	32	3	50	160	32			
ST WNMU 05 007 KYCR	✓	✓	32	3	50	200	32			
ST WNMU 05 008 KYCR	X	✓	33	3	40	160	32			
ST WNMU 05 009 KYCR	X	✓	33	3	40	220	32			
ST WNMU 05 010 KYCR	✓	✓	30	3	40	120	25			
ST WNMU 05 011 KYCR	X	✓	26	2	30	220	25			
ST WNMU 08 002 KYCR	✓	✓	40	3	36	100	20	WNMU 0806	M5X10	T20
ST WNMU 08 003 KYCR	X	✓	40	3	40	160	32			
ST WNMU 08 004 KYCR	✓	✓	40	3	40	150	32			

LOMU 1004 KYCR

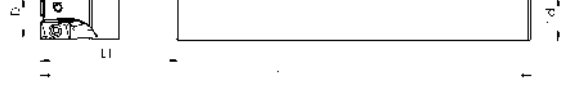

Kesici Uç Uyumluluğu Insert Suitability	Stok / Stock		Takım Ölçüleri / Dimension (mm)					Uç Insert	Vida Screw	Anahtar Torx Key
		Inter Coolant	D	Z	L1	L	d			
KYCR LOMU 1004										
ST LOMU 10 001 KYCR	✓	✓	16	2	45	100	16	LOMU 1004	M3X8	T10
ST LOMU 10 002 KYCR	✓	✓	16	2	36	160	16			
ST LOMU 10 003 KYCR	✓	✓	17	2	36	180	16			
ST LOMU 10 004 KYCR	✓	✓	20	2	36	110	20			
ST LOMU 10 005 KYCR	✓	✓	20	2	36	150	20			
ST LOMU 10 006 KYCR	✓	✓	20	3	36	200	20			
ST LOMU 10 007 KYCR	✓	✓	21	3	36	180	20			
ST LOMU 10 008 KYCR	✓	✓	25	3	36	120	25			
ST LOMU 10 009 KYCR	✓	✓	25	3	36	180	25			
ST LOMU 10 010 KYCR	✓	✓	16	2	36	150	16			
ST LOMU 10 011 KYCR	✓	✓	25	3	36	150	25			
ST LOMU 10 012 KYCR	✓	✓	20	3	35	110	20			
ST LOMU 10 013 KYCR	✓	✓	20	3	50	160	20			
ST LOMU 10 014 KYCR	✓	✓	26	3	30	160	25			
ST LOMU 10 015 KYCR	✓	✓	25	3	50	160	25			
ST LOMU 10 016 KYCR	✓	✓	25	3	60	200	25			
ST LOMU 10 017 KYCR	✓	✓	28	4	30	160	25			
ST LOMU 10 018 KYCR	✓	✓	17	2	30	180	16			
ST LOMU 10 019 KYCR	✓	✓	21	3	30	200	20			

SOMT 1004 KYCR



Kesici Uç Uyumluluğu Insert Suitability	Stok / Stock		Takım Ölçüleri / Dimension (mm)					Uç Insert	Vida Screw	Anahtar Torx Key
		Inter Cooland	D	Z	L1	L	d			
KYCR SOMT 1004										
ST SOMT 10 001 KYCR	✓	✓	25	2	50	160	25	SOMT 1004	M4X11	T15
ST SOMT 10 002 KYCR	✓	✓	26	2	30	160	25			
ST SOMT 10 003 KYCR	✓	✓	33	3	40	160	32			

ZPMT 1003 DJT

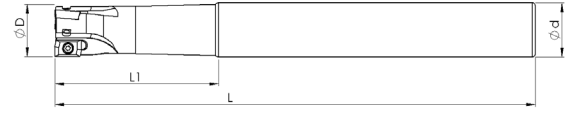

Kesici Uç Uyumluluğu Insert Suitability	Stok / Stock		Takım Ölçüleri / Dimension (mm)					Uç Insert	Vida Screw	Anahtar Torx Key
		Inter Cooland	D	Z	L1	L	d			
DJT ZPMT 1003										
ST ZPMT 10 001 DJT	X	X	16	2	50	160	16	ZPMT 1003	M2.5X7	T08
ST ZPMT 10 002 DJT	X	X	20	3	50	160	20			
ST ZPMT 10 003 DJT	X	X	20	3	50	180	20			
ST ZPMT 10 004 DJT	X	X	25	4	50	160	25			
ST ZPMT 10 005 DJT	X	X	25	4	60	200	25			
ST ZPMT 10 006 DJT	X	X	32	5	70	200	32			
ST ZPMT 10 007 DJT	X	X	32	4	70	200	32			

XDKT 0703 CRTZ



Kesici Uç Uyumluluğu Insert Suitability	Stok / Stock		Takım Ölçüleri / Dimension (mm)					Uç Insert	Vida Screw	Anahtar Torx Key
		Inter Cooland	D	Z	L1	L	d			
CRTZ XDKT 0703										
ST XDKT 07 001 CRTZ	✓	X	10	1	25	100	10	XDKT 0703	M2,2X5	T10
ST XDKT 07 002 CRTZ	✓	X	12	2	25	100	12			

XDKT 11T3 CRTZ



Kesici Uç Uyumluluğu Insert Suitability	Stok / Stock		Takım Ölçüleri / Dimension (mm)					Uç Insert	Vida Screw	Anahtar Torx Key
		Inter Cooland	D	Z	L1	L	d			
CRTZ XDKT 11T3										
ST XDKT 11T 001 CRTZ	✓	✗	16	2	30	150	15	XDKT 11T3	M2.5X6	T8
ST XDKT 11T 002 CRTZ	✓	✗	20	3	30	150	19		M2.5X7	
ST XDKT 11T 003 CRTZ	✓	✗	25	3	30	150	24			
ST XDKT 11T 004 CRTZ	✓	✗	32	4	40	150	25			

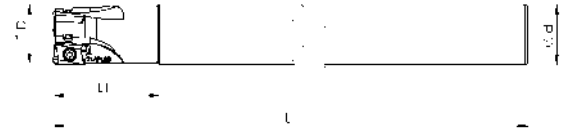

APKT 1003 BHLR



Kesici Uç Uyumluluğu Insert Suitability	Stok / Stock		Takım Ölçüleri / Dimension (mm)					Uç Insert	Vida Screw	Anahtar Torx Key
		Inter Cooland	D	Z	L1	L	d			
BHLR APKT 1003										
ST APKT 10 001 BHLR	✓	✗	16	2	30	150	15	APKT 1003	M2.5X6	T10
ST APKT 10 002 BHLR	✓	✗	20	3	60	200	20		M2.5X7	
ST APKT 10 003 BHLR	✓	✗	21	2	30	200	20			
ST APKT 10 004 BHLR	✓	✗	21	3	60	200	21			

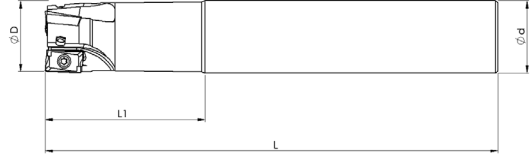

APKT 1604 BHLR

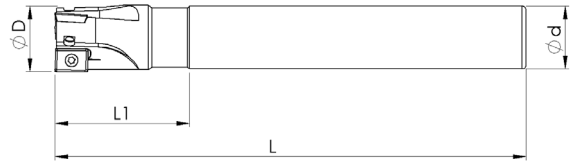

Kesici Uç Uyumluluğu Insert Suitability	Stok / Stock		Takım Ölçüleri / Dimension (mm)					Uç Insert	Vida Screw	Anahtar Torx Key
		Inter Cooland	D	Z	L1	L	d			
BHLR APKT 1604										
ST APKT 16 001 BHLR	✓	X	25	2	50	150	25	APKT 1604	M4X11	T15
ST APKT 16 002 BHLR	✓	X	32	3	50	150	32			
ST APKT 16 003 BHLR	✓	X	40	3	40	200	32			

LDHT 0802 ARNO



Kesici Uç Uyumluluğu Insert Suitability	Stok / Stock		Takım Ölçüleri / Dimension (mm)					Uç Insert	Vida Screw	Anahtar Torx Key
		Inter Cooland	D	Z	L1	L	d			
ARNO LDHT 0802										
ST LDHT 08 001 ARNO	✓	X	16	2	40	120	16	LDHT 0802	M2,5X6	T8
ST LDHT 08 002 ARNO	✓	X	18	3	30	120	16			

SDMT 06/09 ZCC

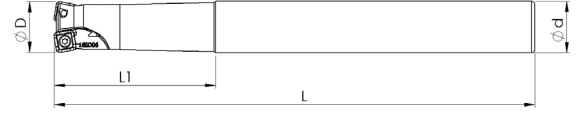

Kesici Uç Uyumluluğu Insert Suitability	Stok / Stock		Takım Ölçüleri / Dimension (mm)					Uç İnsert	Vida Screw	Pabuç Clamp	Vida Screw	Anahtar Torx Key
	ZCC SDMT 06/09	Inter Cooland	D	Z	L1	L	d					
ST SDMT 06 001 ZCC	✓	✓	12	1	25	120	12	SDMT 06T2	M2,2X5	-	-	T6
ST SDMT 06 002 ZCC	✓	✓	16	2	40	150	16					
ST SDMT 06 003 ZCC	✓	✓	17	2	25	160	16					
ST SDMT 06 004 ZCC	✓	✓	20	3	40	160	20					
ST SDMT 06 005 ZCC	✓	✓	20	2	40	150	20					
ST SDMT 06 006 ZCC	✓	✓	20	3	40	150	20					
ST SDMT 06 007 ZCC	✓	✓	21	3	25	200	20					
ST SDMT 06 008 ZCC	✓	✓	22	3	25	150	20					
ST SDMT 06 009 ZCC	✓	✓	25	4	50	150	25					
ST SDMT 06 010 ZCC	✓	✓	25	4	50	180	25					
ST SDMT 06 011 ZCC	✓	✓	26	4	30	200	25					
ST SDMT 06 012 ZCC	✓	✓	32	5	60	200	32					
ST SDMT 09 001 ZCC	✓	✓	22	2	30	150	20	SDMT 09T3	M3,5X8	CK14	M3,5X10	T15
ST SDMT 09 002 ZCC	✓	✓	22	2	25	170	20					
ST SDMT 09 003 ZCC	✓	✓	25	2	60	150	25					
ST SDMT 09 005 ZCC	✓	✓	25	2	40	160	25					
ST SDMT 09 006 ZCC	✓	✓	26	2	30	200	25					
ST SDMT 09 007 ZCC	✓	✓	32	3	30	150	25					
ST SDMT 09 008 ZCC	✓	✓	32	3	50	150	32					
ST SDMT 09 009 ZCC	✓	✓	32	3	50	160	32					
ST SDMT 09 010 ZCC	✓	✓	32	3	50	170	32					
ST SDMT 09 011 ZCC	✓	✓	33	3	30	200	32					
ST SDMT 09 012 ZCC	✓	✓	42	4	40	160	32					
ST SDMT 09 013 ZCC	✓	✓	33	3	40	160	32					
ST SDMT 09 014 ZCC	✓	✓	32	3	60	200	32					
ST SDMT 09 015 ZCC	✓	✓	25	2	60	200	25					
ST SDMT 09 016 ZCC	✓	✓	25	3	50	160	25					
ST SDMT 09 017 ZCC	✓	✓	25	2	40	120	25					
ST SDMT 09 018 ZCC	✓	✓	32	3	40	120	32					
ST SDMT 09 019 ZCC	✓	✓	26	2	30	160	25					
ST SDMT 09 020 ZCC	✓	✓	26	3	30	160	25					
ST SDMT 09 021 ZCC	✓	✓	26	3	30	160	25					
ST SDMT 09 022 ZCC	✓	✓	33	3	30	250	32					
ST SDMT 09 023 ZCC	✓	✓	35	4	30	160	32					
ST SDMT 09 024 ZCC	✓	✓	25	3	60	200	25					

SDMT 1204 ZCC

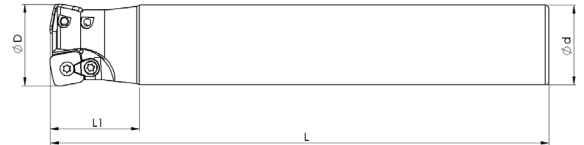

Kesici Uç Uyumluluğu Insert Suitability	Stok / Stock		Takım Ölçüleri / Dimension (mm)					Uç İnsert	Vida Screw	Anahtar Torx Key	Pabuç Clamp	Vida Screw	Anahtar Torx Key
	ZCC SDMT 1204	Inter Cooland	D	Z	L1	L	d						
ST SDMT 12 001 ZCC	✓	✓	32	2	60	200	32	SDMT 1204	M4X11	CK14	CK14	M3,5X11	T15
ST SDMT 12 002 ZCC	✓	✓	40	3	40	200	32						

Lütfen Sipariş vermeden önce stok durumunu sorunuz.
Please ask before ordering, stock status.

L: Sol / Left

R: Sağ / Right

✓ Stokta / In Stock

✗ Stokta Yok / Non Stock

WPGT 0503 ZCC

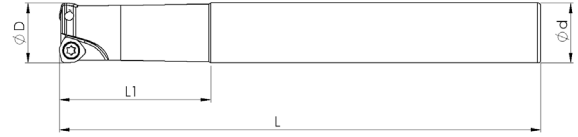

Kesici Uç Uyumluluğu Insert Suitability	Stok / Stock		Takım Ölçüleri / Dimension (mm)					Uç Insert	Vida Screw	Anahtar Torx Key
		Inter Cooland	D	Z	L1	L	d			
ZCC WPGT 0503										
ST WPGT 05 001 ZCC	✓	✓	21	2	30	170	20	WPGT 0503	M3,5X8	T15
ST WPGT 05 002 ZCC	✓	✓	26	3	30	200	25			
ST WPGT 05 003 ZCC	✓	✓	32	4	60	200	32			
ST WPGT 05 004 ZCC	✓	✓	20	2	50	160	20			

SP..08T3 PLBT

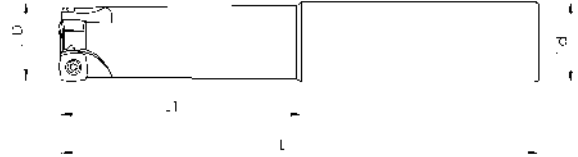

Kesici Uç Uyumluluğu Insert Suitability	Stok / Stock		Takım Ölçüleri / Dimension (mm)					Uç Insert	Vida Screw	Anahtar Torx Key
		Inter Cooland	D	Z	L1	L	d			
PLBT SP..08T3/09T3										
ST SPKT 08 001 PLBT	X	X	20	2	60	150	20	SP..09T308	M3X10	T10
ST SPKT 09 002 PLBT	X	X	25	3	70	150	25			

SDMX 09T308 PLBT

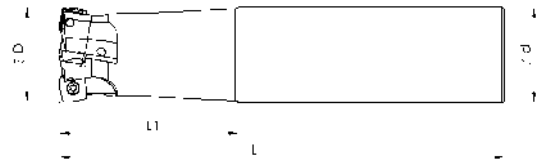

Kesici Uç Uyumluluğu Insert Suitability	Stok / Stock		Takım Ölçüleri / Dimension (mm)					Uç Insert	Vida Screw	Anahtar Torx Key
		Inter Cooland	D	Z	L1	L	d			
PLBT SMDX 09T308										
ST SDMX 09 001 PLBT	✓	✓	22	2	30	150	20	SDMX 09T308	M3X8	T10
ST SDMX 09 002 PLBT	✓	✓	25	3	50	150	25			
ST SDMX 09 003 PLBT	✓	✓	32	4	50	150	32			

BLMP 0603 TT

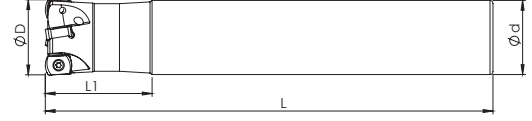

Kesici Uç Uyumluluğu Insert Suitability	Stok / Stock		Takım Ölçüleri / Dimension (mm)					Uç Insert	Vida Screw	Anahtar Torx Key
	TT BLM. 0603	Inter Cooland	D	Z	L1	L	d			
ST BLMP 06 001 TT	✓	✓	16	2	30	150	15	BLM.0603	M2,5X8	T8
ST BLMP 06 002 TT	✓	✓	16	2	50	150	16			
ST BLMP 06 003 TT	✓	✓	17	2	30	150	16			
ST BLMP 06 004 TT	✓	✓	17	2	30	200	16			
ST BLMP 06 005 TT	✓	✓	21	3	30	150	20			
ST BLMP 06 006 TT	✓	✓	21	3	30	200	20			
ST BLMP 06 007 TT	✓	✓	26	4	30	150	25			
ST BLMP 06 008 TT	✓	✓	26	4	30	200	25			
ST BLMP 06 009 TT	✓	✓	25	4	50	150	25			
ST BLMP 06 010 TT	✓	✓	20	3	50	150	20			
ST BLMP 06 011 TT	✓	✓	32	5	60	200	32			
ST BLMP 06 012 TT	✓	✓	33	5	40	200	32			
ST BLMP 06 013 TT	✓	✓	17	2	30	100	16			

LPGT 0102 KYCR



Kesici Uç Uyumluluğu Insert Suitability	Stok / Stock		Takım Ölçüleri / Dimension (mm)					Uç Insert	Vida Screw	Anahtar Torx Key
	KYCR LPGT 0102	Inter Cooland	D	Z	L1	L	d			
ST LPGT 01 001 KYCR	✓	X	9	1	15	75	10	LPGT 0102	M2X5	T6
ST LPGT 01 002 KYCR	✓	✓	10	2	20	100	10			
ST LPGT 01 003 KYCR	✓	✓	11	2	22	120	10			
ST LPGT 01 004 KYCR	✓	✓	12	2	20	120	11			
ST LPGT 01 005 KYCR	✓	✓	12	3	20	120	11			
ST LPGT 01 006 KYCR	✓	✓	12	2	25	120	12			
ST LPGT 01 007 KYCR	✓	✓	12	3	80	150	12			
ST LPGT 01 008 KYCR	✓	✓	14	3	40	100	14			
ST LPGT 01 009 KYCR	✓	✓	14	3	40	160	16			
ST LPGT 01 010 KYCR	✓	✓	16	4	30	160	16			
ST LPGT 01 011 KYCR	✓	✓	12	2	25	100	12			
ST LPGT 01 012 KYCR	✓	✓	12	3	25	120	12			
ST LPGT 01 013 KYCR	✓	✓	14	3	30	120	14			
ST LPGT 01 014 KYCR	✓	X	10	3	30	120	09			

LOGU 0303 KYCR

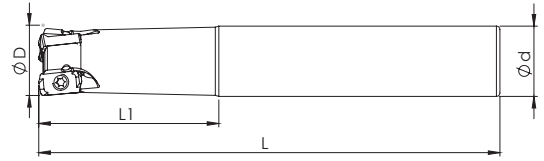

Kesici Uç Uyumluluğu Insert Suitability	Stok / Stock		Takım Ölçüleri / Dimension (mm)					Uç İnsert	Vida Screw	Anahtar Torx Key
		Inter Cooland	D	Z	L1	L	d			
KYCR LOGU 030310										
ST LOGU 03 001 KYCR	✓	✓	16	2	35	100	16	LOGU 0303	M3X8 LOGU	T8
ST LOGU 03 002 KYCR	✓	✓	16	2	50	160	16			
ST LOGU 03 003 KYCR	✓	✓	16	2	60	200	16			
ST LOGU 03 004 KYCR	✓	✓	17	2	30	160	16			
ST LOGU 03 005 KYCR	✓	✓	17	2	30	200	16			
ST LOGU 03 006 KYCR	✓	✓	18	2	30	160	16			
ST LOGU 03 007 KYCR	✓	✓	20	3	40	130	20			
ST LOGU 03 008 KYCR	✓	✓	20	3	50	160	20			
ST LOGU 03 009 KYCR	✓	✓	20	3	60	220	20			
ST LOGU 03 010 KYCR	✓	✓	21	3	30	160	20			
ST LOGU 03 011 KYCR	✓	✓	22	3	30	160	20			
ST LOGU 03 012 KYCR	✓	✓	22	3	30	180	20			
ST LOGU 03 013 KYCR	✓	✓	25	4	50	160	25			
ST LOGU 03 014 KYCR	✓	✓	25	4	50	180	25			
ST LOGU 03 015 KYCR	✓	✓	26	4	30	180	25			
ST LOGU 03 016 KYCR	✓	✓	26	4	30	160	25			
ST LOGU 03 017 KYCR	✓	X	26	2	30	300	25			
ST LOGU 03 018 KYCR	✓	✓	28	5	30	160	25			
ST LOGU 03 019 KYCR	✓	✓	28	5	30	180	25			
ST LOGU 03 020 KYCR	✓	✓	32	5	50	160	32			
ST LOGU 03 021 KYCR	✓	✓	32	5	60	200	32			
ST LOGU 03 022 KYCR	✓	✓	33	5	40	160	32			
ST LOGU 03 023 KYCR	✓	✓	25	4	50	150	25			
ST LOGU 03 024 KYCR	✓	✓	28	4	30	160	25			
ST LOGU 03 025 KYCR	✓	✓	16	2	30	160	15			
ST LOGU 03 026 KYCR	✓	✓	20	3	60	200	20			
ST LOGU 03 027 KYCR	✓	✓	20	3	35	110	20			
ST LOGU 03 028 KYCR	✓	✓	20	3	35	100	20			
ST LOGU 03 029 KYCR	✓	✓	26	4	30	200	25			
ST LOGU 03 030 KYCR	✓	X	26	4	30	250	25			
ST LOGU 03 031 KYCR	✓	✓	16	2	35	110	16			
ST LOGU 03 032 KYCR	✓	✓	21	3	30	200	20			
ST LOGU 03 033 KYCR	✓	✓	28	4	30	200	25			

SOMT 12T3 MTSBHS

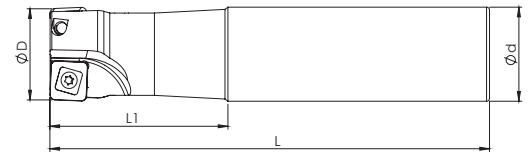

Kesici Uç Uyumluluğu Insert Suitability	Stok / Stock		Takım Ölçüleri / Dimension (mm)					Uç İnsert	Vida Screw	Anahtar Torx Key
		Inter Cooland	D	Z	L1	L	d			
MTSBHS SOMT 12T308										
ST SOMT 12 001 MTSBHS	✓	✓	32	2	50	150	32	SOMT 12T3	M5X12	T20
ST SOMT 12 002 MTSBHS	✓	✓	40	3	40	150	32			

P26335 R10/R14 WLTR

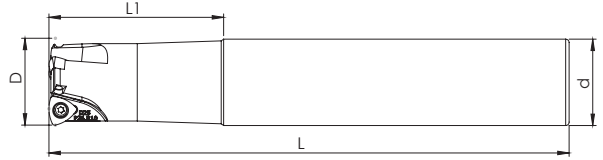

Kesici Uç Uyumluluğu Insert Suitability	Stok / Stock		Takım Ölçüleri / Dimension (mm)					Uç İnsert	Vida Screw	Anahtar Torx Key
	WLTR P26335 -R10-R14	Inter Cooland	D	Z	L1	L	d			
✓	✓	21	2	30	120	20	P26335 R10	M2,5X8	T8	
✓	✓	25	3	50	150	25				
✓	✓	26	3	30	200	25				
✓	✓	32	4	50	150	32	P26335 R14	M4X10	T15	
✓	✓	32	3	50	150	32				

WNMX 09T3 KRLY

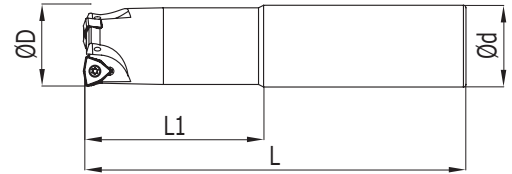

Kesici Uç Uyumluluğu Insert Suitability	Stok / Stock		Takım Ölçüleri / Dimension (mm)					Uç İnsert	Vida Screw	Anahtar Torx Key
	KRLY WNMX 09T316	Inter Cooland	D	Z	L1	L	d			
✓	✓	25	2	70	150	25	WNMX 09T3	M3X8	T10	
✓	✓	32	3	70	150	32				

WNMX 0603 KRLY

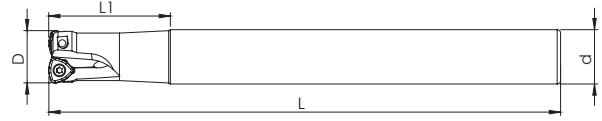

Kesici Uç Uyumluluğu Insert Suitability	Stok / Stock		Takım Ölçüleri / Dimension (mm)					Uç Insert	Vida Screw	Anahtar Torx Key
		Inter Cooland	D	Z	L1	L	d			
KRLY WNMX 060312										
ST WNMX 06 001 KRLY	✓	✓	16	2	70	150	16	WNMX 0603	M2,5X8	T8
ST WNMX 06 002 KRLY	✓	✓	20	3	70	150	20			
ST WNMX 06 003 KRLY	✓	✓	17	2	25	150	16			
ST WNMX 06 004 KRLY	✓	✓	21	3	25	150	20			

LPMW 0402 KRLY

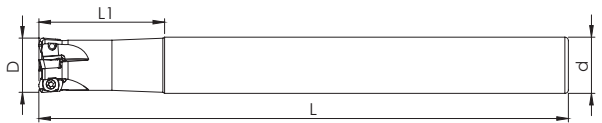

Kesici Uç Uyumluluğu Insert Suitability	Stok / Stock		Takım Ölçüleri / Dimension (mm)					Uç Insert	Vida Screw	Anahtar Torx Key
		Inter Cooland	D	Z	L1	L	d			
KRLY LPMW 0402										
ST LPMW 0402 001 KRLY	✓	X	10	2	35	120	10	LPMW 0402	M1,8X4,2	T6
ST LPMW 0402 002 KRLY	✓	X	12	3	35	120	12			
ST LPMW 0402 003 KRLY	✓	X	16	4	50	150	16			
ST LPMW 0402 004 KRLY	✓	X	16	4	35	120	16			
ST LPMW 0402 005 KRLY	✓	X	14	4	30	120	12			

LNMX 060310 KRLY

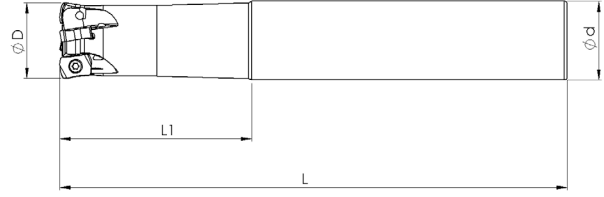

Kesici Uç Uyumluluğu Insert Suitability	Stok / Stock		Takım Ölçüleri / Dimension (mm)					Uç Insert	Vida Screw	Anahtar Torx Key
		Inter Cooland	D	Z	L1	L	d			
KRLY LNMX 0603										
ST LNMX 06 001 KRLY	✓	✓	16	2	40	130	16	LNMX 060310	M3X8	T10
ST LNMX 06 002 KRLY	✓	✓	20	3	50	150	20			
ST LNMX 06 003 KRLY	✓	✓	25	4	50	160	25			
ST LNMX 06 004 KRLY	✓	✓	17	2	30	160	16			
ST LNMX 06 005 KRLY	✓	✓	17	2	30	200	16			
ST LNMX 06 006 KRLY	✓	✓	16	2	50	150	16			
ST LNMX 06 007 KRLY	✓	X	20	3	60	250	20			
ST LNMX 06 008 KRLY	✓	✓	21	3	30	150	20			
ST LNMX 06 009 KRLY	✓	✓	25	4	50	150	25			
ST LNMX 06 010 KRLY	✓	X	25	4	60	250	25			
ST LNMX 06 011 KRLY	✓	✓	32	5	50	150	32			
ST LNMX 06 012 KRLY	✓	✓	32	6	50	150	32			
ST LNMX 06 013 KRLY	✓	✓	40	6	40	150	32			

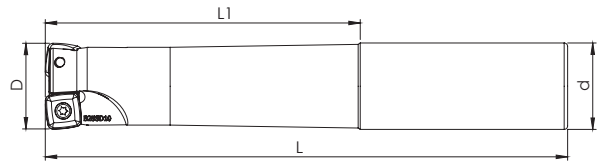

SDMT 1004 BHLR



Kesici Uç Uyumluluğu Insert Suitability	Stok / Stock		Takım Ölçüleri / Dimension (mm)					Uç Insert	Vida Screw	Anahtar Torx Key
		Inter Cooland	D	Z	L1	L	d			
BHLR SDMT 1004										
ST SDMT 10 001 BHLR	✓	✓	17	1	30	150	12	SDMT 1004	M3X8	T10
ST SDMT 10 002 BHLR	✓	✓	25	2	90	150	25			
ST SDMT 10 003 BHLR	✓	✓	32	3	90	150	32			
ST SDMT 10 004 BHLR	✓	✓	26	2	30	200	25			
ST SDMT 10 005 BHLR	✓	✓	33	3	30	200	32			
ST SDMT 10 006 BHLR	✓	✓	26	2	30	200	25			

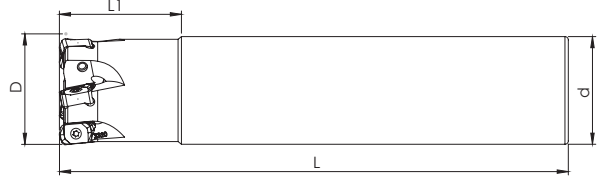

BNGX 10T3 PRMT

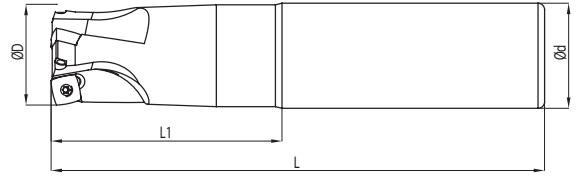

Kesici Uç Uyumluluğu Insert Suitability	Stok / Stock		Takım Ölçüleri / Dimension (mm)					Uç Insert	Vida Screw	Anahtar Torx Key
		Inter Cooland	D	Z	L1	L	d			
PRMT BNGX 10T3										
ST BNGX 10T3 001 PRMT	X	✓	17	2	30	150	16	BNGX 10T3	M2,5X8	T8
ST BNGX 10T3 002 PRMT	X	✓	21	3	30	150	20			
ST BNGX 10T3 003 PRMT	X	✓	26	4	30	150	25			
ST BNGX 10T3 004 PRMT	X	✓	26	4	30	200	25			
ST BNGX 10T3 005 PRMT	X	✓	33	5	30	150	32			
ST BNGX 10T3 006 PRMT	X	✓	33	5	30	200	32			

ZDCW 09T3 PRMT



Kesici Uç Uyumluluğu Insert Suitability	Stok / Stock		Takım Ölçüleri / Dimension (mm)					Uç Insert	Vida Screw	Anahtar Torx Key
		Inter Cooland	D	Z	L1	L	d			
PRMT ZDCW 09T3										
ST ZDCW 09 001 PRMT	✓	✓	20	2	50	150	20	ZDCW 09T3	M3X8	T15
ST ZDCW 09 002 PRMT	✓	✓	25	2	50	150	25			
ST ZDCW 09 003 PRMT	✓	✓	32	3	50	150	32			

LNMU 0303 TNGLY

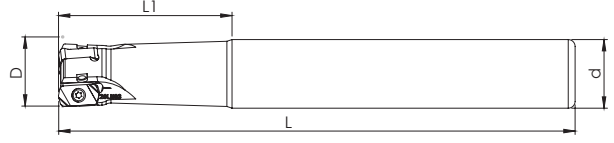

Kesici Uç Uyumluluğu Insert Suitability	Stok / Stock		Takım Ölçüleri / Dimension (mm)					Uç Insert	Vida Screw	Anahtar Torx Key
		Inter Cooland	D	Z	L1	L	d			
TNGLY LNMU 0303										
ST LNMU 03 001 TNG	✓	✓	16	2	50	160	16	LNMU 0303	M2,5X7	T8
ST LNMU 03 002 TNG	✓	✓	18	2	30	150	16			
ST LNMU 03 003 TNG	✓	✓	20	3	50	160	20			
ST LNMU 03 004 TNG	✓	✓	21	3	30	160	20			
ST LNMU 03 005 TNG	✓	✓	22	3	30	150	20			
ST LNMU 03 006 TNG	✓	✓	25	4	50	160	25			
ST LNMU 03 007 TNG	✓	✓	32	4	50	160	32			
ST LNMU 03 008 TNG	✓	✓	21	3	30	200	20			
ST LNMU 03 009 TNG	✓	✓	25	4	60	200	25			
ST LNMU 03 010 TNG	✓	✓	26	4	30	160	25			
ST LNMU 03 011 TNG	✓	✓	32	4	60	200	32			
ST LNMU 03 012 TNG	✓	✓	33	4	30	200	32			
ST LNMU 03 013 TNG	✓	X	26	4	30	250	25			
ST LNMU 03 014 TNG	✓	✓	26	4	30	200	25			
ST LNMU 03 015 TNG	✓	✓	20	3	60	200	20			
ST LNMU 03 016 TNG	✓	✓	22	3	30	160	20			
ST LNMU 03 017 TNG	✓	✓	17	2	30	160	16			
ST LNMU 03 018 TNG	✓	✓	17	2	30	200	16			
ST LNMU 03 019 TNG	✓	✓	33	5	30	160	32			
ST LNMU 03 020 TNG	✓	✓	16	2	60	200	16			
ST LNMU 03 021 TNG	✓	X	16	2	60	250	16			

WOEJ 0804 WDA

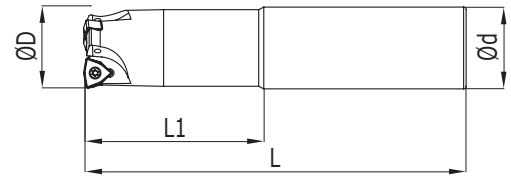

Kesici Uç Uyumluluğu Insert Suitability	Stok / Stock		Takım Ölçüleri / Dimension (mm)					Uç Insert	Vida Screw	Anahtar Torx Key
		Inter Cooland	D	Z	L1	L	d			
WDA WOEJ 0804										
ST WOEJ 08 001 WDA	X	✓	25	2	60	150	25	WOEJ 0804	M3X8	T10
ST WOEJ 08 002 WDA	X	✓	25	2	80	200	25			
ST WOEJ 08 003 WDA	X	✓	32	3	60	150	32			
ST WOEJ 08 004 WDA	X	✓	32	3	80	200	32			

XPPT 070308 WDA

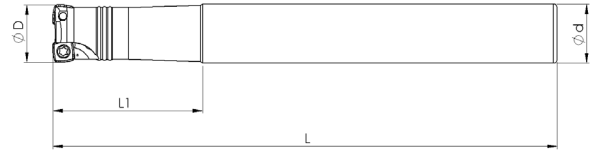

Kesici Uç Uyumluluğu Insert Suitability	Stok / Stock		Takım Ölçüleri / Dimension (mm)					Uç Insert	Vida Screw	Anahtar Torx Key
		Inter Cooland	D	Z	L1	L	d			
WDA XPPT 0703										
ST XPPT 07 001 WDA	✓	✓	16	2	50	170	16	XPPT 070308	M3X8	T10
ST XPPT 07 002 WDA	✓	✓	20	2	50	170	20			
ST XPPT 07 003 WDA	✓	✓	25	3	60	200	25			
ST XPPT 07 004 WDA	✓	✓	26	3	30	200	25			
ST XPPT 07 005 WDA	✓	✓	33	4	40	200	32			
ST XPPT 07 006 WDA	✓	✓	17	2	30	170	16			
ST XPPT 07 007 WDA	✓	✓	20	3	50	170	20			

SOMW 0803 SNG

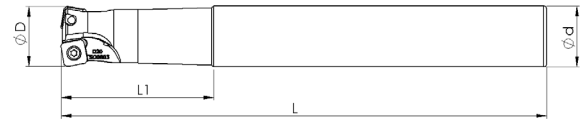



Kesici Uç Uyumluluğu Insert Suitability	Stok / Stock		Takım Ölçüleri / Dimension (mm)					Uç Insert	Vida Screw	Anahtar Torx Key
		Inter Cooland	D	Z	L1	L	d			
SNG SOMW 0803										
ST SOMW 08 001 SNG	✓	✓	17	2	30	160	16	SOMW 0803	M3X8	T10
ST SOMW 08 002 SNG	✓	✓	20	2	50	160	20			
ST SOMW 08 003 SNG	✓	✓	25	3	50	160	25			
ST SOMW 08 004 SNG	✓	✓	32	4	50	160	32			
ST SOMW 08 005 SNG	✓	✓	26	3	30	200	25			
ST SOMW 08 006 SNG	✓	✓	20	2	50	200	20			
ST SOMW 08 007 SNG	✓	✓	25	3	50	200	25			
ST SOMW 08 008 SNG	✓	✓	32	4	50	200	32			

YNGX 0603 SNG

NEW



Kesici Uç Uyumluluğu Insert Suitability	Stok / Stock		Takım Ölçüleri / Dimension (mm)					Uç Insert	Vida Screw	Anahtar Torx Key
		Inter Cooland	D	Z	L1	L	d			
SNG YNGX 0603								YNGX 0603	M3X6	T10
ST YNGX 06 001 SNG	✓	✓	16	2	45	160	16			
ST YNGX 06 002 SNG	✓	✓	17	2	30	160	16			
ST YNGX 06 003 SNG	✓	✓	20	3	50	160	20			
ST YNGX 06 004 SNG	✓	✓	21	3	30	160	20			
ST YNGX 06 005 SNG	✓	✓	25	3	50	160	25			
ST YNGX 06 006 SNG	✓	✓	26	3	30	160	25			
ST YNGX 06 007 SNG	✓	✓	32	4	50	160	32			

SPMW 1204 SNG

NEW

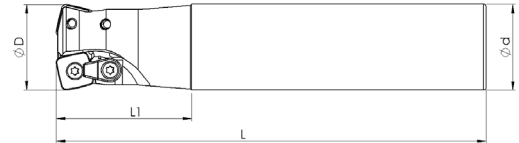

Kesici Uç Uyumluluğu Insert Suitability	Stok / Stock		Takım Ölçüleri / Dimension (mm)					Uç Insert	Vida Screw	Pabuç Clamp	Vida Screw	Anahtar Torx Key
		Inter Cooland	D	Z	L1	L	d					
SNG SPMW 1204								SPMW 1204	M4	CK 15	M4X11	T15
ST SPMW 12 001 SNG	✓	✓	32	2	50	160	32					
ST SPMW 12 002 SNG	✓	✓	40	3	40	160	32					

XPW. 0603 VNDRT

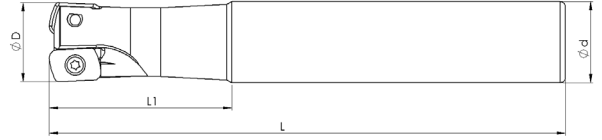

Kesici Uç Uyumluluğu Insert Suitability	Stok / Stock		Takım Ölçüleri / Dimension (mm)					Uç Insert	Vida Screw	Anahtar Torx Key
		Inter Cooland	D	Z	L1	L	d			
VNDRT XPW.0603TN SCO XN..04-08										
ST XPW 06 001 VNDRT	✓	✓	16	2	35	100	16	XPW. 0603	M2,5X6	T8
ST XPW 06 002 VNDRT	✓	✓	17	2	30	150	16			
ST XPW 06 003 VNDRT	✓	✓	20	3	35	100	20			
ST XPW 06 004 VNDRT	✓	✓	21	3	30	150	20			
ST XPW 06 005 VNDRT	✓	✓	25	4	35	100	25		M2,5X7	

XDHW 060210 PLBT / VNDRT

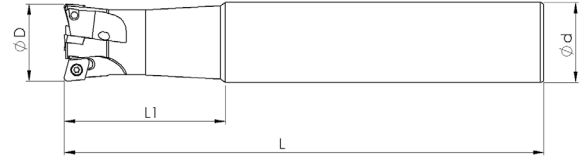

Kesici Uç Uyumluluğu Insert Suitability	Stok / Stock		Takım Ölçüleri / Dimension (mm)					Uç Insert	Vida Screw	Anahtar Torx Key
		Inter Cooland	D	Z	L1	L	d			
PLBT / VNDRT XDHW 060210										
ST XDHW 06 001 PLB/VND	✓	✓	16	2	50	150	16	XDHW 060210	M2,5X6	T8
ST XDHW 06 002 PLB/VND	✓	✓	17	2	30	150	16			
ST XDHW 06 003 PLB/VND	✓	✓	20	3	50	150	20			
ST XDHW 06 004 PLB/VND	✓	✓	25	4	50	150	25		M2,5X7	

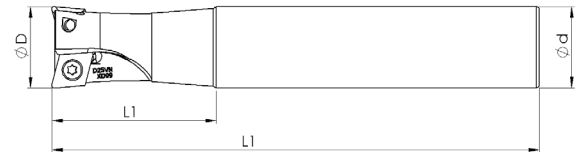

XDHW 09T310 VNDRT



Kesici Uç Uyumluluğu Insert Suitability	Stok / Stock		Takım Ölçüleri / Dimension (mm)					Uç Insert	Vida Screw	Anahtar Torx Key
		Inter Cooland	D	Z	L1	L	d			
VNDRT XDHW 09T310										
ST XDHW 09 001 VNDRT	✓	✓	25	2	50	150	25	XDHW 09T310	M4X11	T15
ST XDHW 09 002 VNDRT	✓	✓	32	3	50	150	32			
ST XDHW 09 003 VNDRT	✓	✓	42	4	40	150	32			

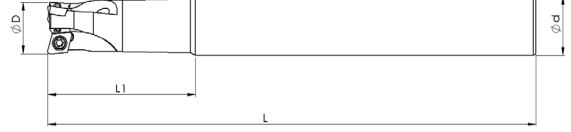

XDHW 040105 VNDRT

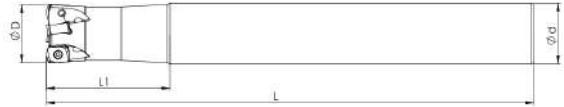

Kesici Uç Uyumluluğu Insert Suitability	Stok / Stock		Takım Ölçüleri / Dimension (mm)					Uç Insert	Vida Screw	Anahtar Torx Key
		Inter Cooland	D	Z	L1	L	d			
VNDRT XDHW 040105										
ST XDHW 04 001 VNDRT	✓	✓	10	2	35	100	10	XDHW 040105	M1,8X4,2	T6
ST XDHW 04 002 VNDRT	✓	✓	12	3	35	100	12			

ENMX 0604 YG



Kesici Uç Uyumluluğu Insert Suitability	Stok / Stock		Takım Ölçüleri / Dimension (mm)					Uç Insert	Vida Screw	Anahtar Torx Key
		Inter Cooland	D	Z	L1	L	d			
YG ENMX 0604										
ST ENMX 06 001 YG	X	✓	20	3	50	200	20	ENMX 0604	M2,5X7	T8
ST ENMX 06 002 YG	X	✓	25	4	50	200	25			
ST ENMX 06 003 YG	X	✓	32	5	60	200	32			

ENMX 08T3 WLTR

NEW

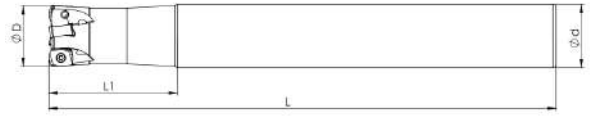

Kesici Uç Uyumluluğu Insert Suitability	Stok / Stock		Takım Ölçüleri / Dimension (mm)					Uç İnsert	Vida Screw	Anahtar Torx Key
		Inter Cooland	D	Z	L1	L	d			
WLTR ENMX 08T3										
ST ENMX 08 001 WLTR	X	✓	16	2	40	150	16	ENMX 0604	M2,5X6	T8
ST ENMX 08 001 WLTR	✓	✓	16	2	30	100	16			
ST ENMX 08 001 WLTR	✓	✓	16	2	50	200	16			
ST ENMX 08 001 WLTR	✓	✓	20	3	40	150	20			
ST ENMX 08 001 WLTR	X	✓	20	3	50	250	20			
ST ENMX 08 001 WLTR	✓	✓	25	4	40	150	25			
ST ENMX 08 001 WLTR	X	✓	32	5	40	140	32		M2,5X7	

WDKT 08 ISO

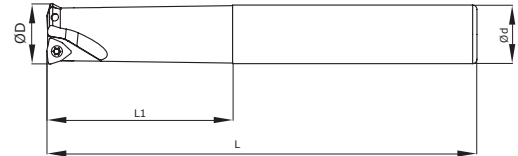

Kesici Uç Uyumluluğu Insert Suitability	Stok / Stock		Takım Ölçüleri / Dimension (mm)					Uç İnsert	Vida Screw	Anahtar Torx Key
		Inter Cooland	D	Z	L1	L	d			
ISO WDKT 08										
ST WDKT 08 001 ISO	✓	X	20	2	70	150	20	WDKT 08..	M3X8	T10
ST WDKT 08 002 ISO	✓	X	25	2	70	150	25			
ST WDKT 08 003 ISO	✓	X	30	2	70	150	32			
ST WDKT 08 004 ISO	✓	X	32	3	70	150	32			

RD..05/07/08/10/12 ISO

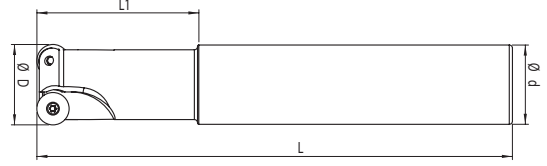

Kesici Uç Uyumluluğu Insert Suitability	Stok / Stock		Takım Ölçüleri / Dimension (mm)					Uç Insert	Vida Screw	Anahtar Torx Key
	ISO RD.. 05/07/08/10/12	Inter Cooland	D	Z	L1	L	d			
ST RD..05 001 ISO	✓	X	10	2	40	100	10	RD..0501	M2X5	T6
ST RD..05 002 ISO	✓	X	10	2	40	100	12			
ST RD..05 003 ISO	✓	X	12	2	40	100	12			
ST RD..07 004 ISO	✓	✓	12	2	20	100	12	RD..07T1	M2,5X6	T8
ST RD..07 005 ISO	✓	✓	12	2	80	140	16			
ST RD..07 006 ISO	✓	✓	15	2	60	110	16	RD..0702	M2,5X6	T8
ST RD..08 007 ISO	✓	✓	16	2	40	120	16			
ST RD..08 008 ISO	✓	✓	16	2	40	150	16	RD..0803	M3X6	T10
ST RD..08 009 ISO	✓	✓	16	2	30	150	16			
ST RD..08 010 ISO	✓	✓	17	2	30	150	16			
ST RD..08 011 ISO	✓	✓	20	3	50	150	20	RD..1003	M3,X8	T15
ST RD..10 009 ISO	✓	✓	32	3	60	200	32			
ST RD..10 012 ISO	✓	✓	20	2	40	120	20			
ST RD..10 013 ISO	✓	✓	20	2	50	150	20			
ST RD..10 014 ISO	✓	✓	20	2	50	200	20			
ST RD..10 015 ISO	✓	✓	25	2	50	150	25			
ST RD..10 016 ISO	✓	✓	25	2	60	200	25			
ST RD..10 017 ISO	✓	✓	32	3	60	150	32			
ST RD..10 018 ISO	✓	✓	32	2	100	250	32			
ST RD..10 019 ISO	✓	✓	32	3	100	250	32			
ST RD..10 020 ISO	✓	✓	40	4	55	150	32	RD..10T3	M3,X8	T15
ST RD..10 021 ISO	✓	✓	40	2	55	250	32			
ST RD..10 022 ISO	✓	✓	40	4	55	250	32			
ST RD..10 023 ISO	✓	✓	20	2	50	150	20			
ST RD..10 024 ISO	✓	✓	25	2	50	150	25			
ST RD..10 025 ISO	✓	✓	25	2	70	200	25			
ST RD..10 027 ISO	✓	✓	32	3	70	150	32			
ST RD..10 028 ISO	✓	✓	32	2	100	250	32			
ST RD..10 029 ISO	✓	✓	40	4	55	150	32			
ST RD..10 030 ISO	✓	✓	40	2	55	250	32			
ST RD..10 031 ISO	✓	✓	40	4	55	250	32	RD..1204	M3,X8	T15
ST RD..10 032 ISO	✓	✓	32	3	50	160	32			
ST RD..12 032 ISO	✓	✓	25	2	50	150	25			
ST RD..12 033 ISO	✓	✓	32	3	30	150	25			
ST RD..12 034 ISO	✓	✓	32	3	60	150	32			
ST RD..12 035 ISO	✓	✓	40	4	55	150	25			
ST RD..12 036 ISO	✓	✓	40	4	55	150	32			
ST RD..12 037 ISO	✓	✓	32	3	60	200	25			
ST RD..12 038 ISO	✓	✓	32	3	40	200	32			
ST RD..12 039 ISO	✓	✓	25	2	40	200	25			

RCKT 1204 ISO

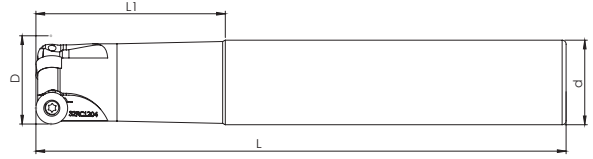

Kesici Uç Uyumluluğu Insert Suitability	Stok / Stock		Takım Ölçüleri / Dimension (mm)					Uç Insert	Vida Screw	Anahtar Torx Key
	ISO	Inter Cooland	D	Z	L1	L	d			
RCKT 1204/2006										
ST RC.. 12 001 ISO	✓	✓	25	2	60	200	25	RCKT 1204	M3,5X8	T15
ST RC.. 12 002 ISO	✓	✓	26	2	30	200	25			
ST RC.. 12 003 ISO	✓	✓	26	2	30	250	25			
ST RC.. 12 004 ISO	✓	✓	32	3	60	200	32			
ST RC.. 12 005 ISO	✓	✓	33	3	30	250	32	RCKT 2006	M6X15	T25
ST RC.. 20 006 ISO	✓	✓	50	3	40	120	32			

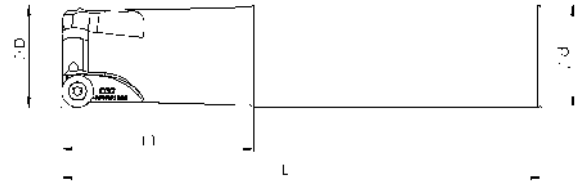

RPMW 1003 ISO



Kesici Uç Uyumluluğu Insert Suitability	Stok / Stock		Takım Ölçüleri / Dimension (mm)					Uç Insert	Vida Screw	Anahtar Torx Key
	ISO	Inter Cooland	D	Z	L1	L	d			
RPMW 1003										
ST RPMW 10 001 ISO	✓	✓	20	2	50	150	20	RPMW 1003	M3,5X9	T10
ST RPMW 10 002 ISO	✓	✓	25	2	50	150	25			
ST RPMW 10 003 ISO	✓	✓	32	3	50	150	32			

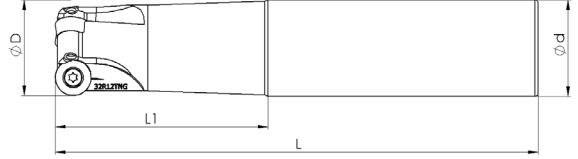

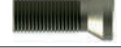
RPMT 1204 TNGLY

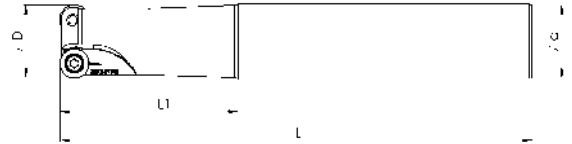

Kesici Uç Uyumluluğu Insert Suitability	Stok / Stock		Takım Ölçüleri / Dimension (mm)					Uç Insert	Vida Screw	Anahtar Torx Key
		Inter Cooland	D	Z	L1	L	d			
TNGLY RPMT 1204										
ST RPMT 12 001 TNG	✓	✓	25	2	50	160	25	RPMT 1204	M4X11	T15
ST RPMT 12 002 TNG	✓	✓	30	3	40	160	25			
ST RPMT 12 003 TNG	✓	✓	32	3	50	160	32			

RPMT 10T3 TNGLY



Kesici Uç Uyumluluğu Insert Suitability	Stok / Stock		Takım Ölçüleri / Dimension (mm)					Uç Insert	Vida Screw	Anahtar Torx Key
		Inter Cooland	D	Z	L1	L	d			
TNGLY RPMT 10T3										
ST RPMT 10T3 001 TNG	✓	✓	20	2	50	150	20	RPMT 10T3	M3,5X8	T15
ST RPMT 10T3 002 TNG	✓	✓	22	2	30	160	20			
ST RPMT 10T3 003 TNG	✓	✓	25	2	50	160	25			
ST RPMT 10T3 004 TNG	✓	✓	30	3	40	160	25			
ST RPMT 10T3 005 TNG	✓	✓	32	3	50	160	32			

RDMX 1003 SNG



Kesici Uç Uyumluluğu Insert Suitability	Stok / Stock		Takım Ölçüleri / Dimension (mm)					Uç Insert	Vida Screw	Anahtar Torx Key
		Inter Cooland	D	Z	L1	L	d			
SNG RDMX 1003										
ST RDMX 10 001 SNG	✓	✓	20	2	50	160	20	RDMX 1003	M3,5X8	T15
ST RDMX 10 002 SNG	✓	✓	25	2	50	160	25			

RDMX 0802 SNG

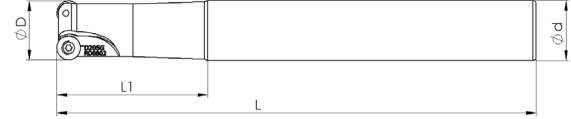

Kesici Uç Uyumluluğu Insert Suitability	Stok / Stock		Takım Ölçüleri / Dimension (mm)					Uç Insert	Vida Screw	Anahtar Torx Key
		Inter Cooland	D	Z	L1	L	d			
SNG RDMX 0802										
ST RDMX 08 001 SNG	✓	✓	16	2	50	160	16	RDMX 0802	M2,5X7	T8
ST RDMX 08 002 SNG	✓	✓	20	2	50	160	20			



RPMT 10T3 KYCR



Kesici Uç Uyumluluğu Insert Suitability	Stok / Stock		Takım Ölçüleri / Dimension (mm)					Uç Insert	Vida Screw	Anahtar Torx Key
		Inter Cooland	D	Z	L1	L	d			
KYCR RPMT 10T3										
ST RPMT 10 001 KYCR	X	✓	20	2	50	120	20	RPMT 10T3	M3X8	T10
ST RPMT 10 002 KYCR	X	✓	25	2	50	150	25			
ST RPMT 10 003 KYCR	X	✓	33	3	40	200	32			
ST RPMT 10 004 KYCR	X	✓	33	3	40	250	32			

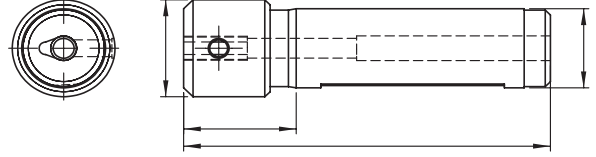

B.ST



Kesici Uç Uyumluluğu Insert Suitability	Stok / Stock		Takım Ölçüleri / Dimension (mm)				Uç İnsert	Vida Screw	Anahtar Torx Key
		Inter Cooland	D	L1	L	d			
HRN B.ST									
A05.0016.07.B.ST HRN	✓	✓	20	20	70	16	A05.0016.07.B.ST	M4X8	T15
A07.0020.07.B.ST HRN	✓	✓	25	20	70	20	A07.0020.07.B.ST		
A08.0020.09.B.ST HRN	✓	✓	25	20	70	20	A08.0020.09.B.ST		
A09.0025.07.B.ST HRN	✓	✓	30	20	90	25	A09.0025.07.B.ST		

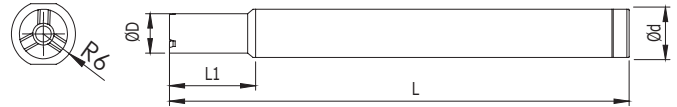



HD 12

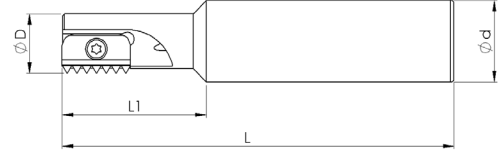

Kesici Uç Uyumluluğu Insert Suitability	Stok / Stock		Takım Ölçüleri / Dimension (mm)				Uç İnsert	Vida Screw	Anahtar Torx Key
		Inter Cooland	D	L1	L	d			
ISO									
HD 12 06 R 001 HRN	✓	X	6	18	100	12	HD-1206 R	M3X10	T10
HD 12 07 R 002 HRN	✓	X	7	18	100	12	HD-1207 R		
HD 12 08 R 003 HRN	✓	X	8	18	100	12	HD-1208 R	M3,5X11	T15
HD 12 09 R 004 HRN	✓	X	9	18	100	12	HD-1209 R		
HD 12 11 R 005 HRN	✓	X	11	18	100	12	HD-1211 R	M4,5X12	T20
HD 12 11 L 005 HRN	✓	X	11	18	100	12	HD-1211 L		

DİŞ TARAĞI



Kesici Uç Uyumluluğu Insert Suitability	Stok / Stock	Takım Ölçüleri / Dimension (mm)					Uç Insert	Vida Screw	Anahtar Torx Key
		D	Z	L1	L	d			
DİŞ TARAĞI CPT-C14-C21							CPT-C14-C21		T15
DT C14 001	✓	16	1	25	120	16			
DT C21 002	✓	18	1	33	100	20			
DT C21 003	✓	21	1	44	120	25			
DT C21 004	✓	25	1	44	120	25			

VİDALI TAKIM TUTUCU

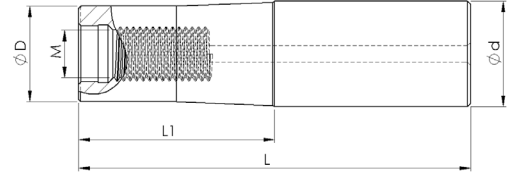

Kesici Uç Uyumluluğu Insert Suitability	Stok / Stock		Takım Ölçüleri / Dimension (mm)					
		Inter Cooland	M	D	d	L1	L	VİDA
VİDALI UZATMA								
VTU M12 001	✓	✓	M12	22	25	60	120	M12
VTU M12 002	✓	✓	M12	22	25	100	160	M12
VTU M12 003	✓	✓	M12	22	25	140	200	M12
VTU M16 004	✓	✓	M16	30	32	60	120	M16
VTU M16 005	✓	✓	M16	30	32	100	160	M16
VTU M16 006	✓	✓	M16	30	32	140	200	M16



HIGH FEED FINISH TAKIMLARI
HIGH FEED FINISH TOOLS

KÜRE 08/10/12/16 20/25/30/32 WLTR

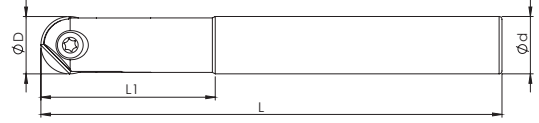

Kesici Uç Uyumluluğu Insert Suitability	Stok / Stock	Takım Ölçüleri / Dimension (mm)				Uç Insert	Vida Screw	Anahtar Torx Key
		D	d	L1	L			
WLTR P3201/P3204								
ST P3201 002 WLTR	✓	10	12	30	130	P3210-D10	M4x9 D10	T15
ST P3204 003 WLTR	✓	12	12	32	130	P3212-D12	M5x10 D12	T20
ST P3204 004 WLTR	✓	16	16	36	140	P3216-D16	M5x12 D16	
ST P3204 005 WLTR	✓	20	20	45	160	P3220-D20	M5x16 D20	
ST P3201 006 WLTR	✓	25	25	45	160	P3225-D25	M6x22 D25	

ROHX 12/16/20 ZCC

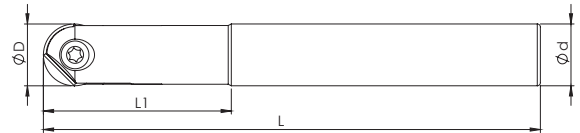

Kesici Uç Uyumluluğu Insert Suitability	Stok / Stock	Takım Ölçüleri / Dimension (mm)				Uç Insert	Vida Screw	Anahtar Torx Key
		D	d	L1	L			
ZCC ROHX 12/16/20								
ST ROHX 12 001 ZCC	✓	12	16	45	130	R0HX 1203	M4X0,5X9	T15
ST ROHX 16 002 ZCC	✓	16	16	45	160	R0HX 1604	M5X0,5X10	T20
ST ROHX 16 003 ZCC	✓	16	16	60	190			
ST ROHX 16 004 ZCC	✓	16	16	60	250			
ST ROHX 20 005 ZCC	✓	20	20	45	160	R0HX 2005	M5X0,5X13	
ST ROHX 20 006 ZCC	✓	20	20	60	200			
ST ROHX 20 007 ZCC	✓	20	20	60	250			
ST ROHX 20 008 ZCC	✓	20	25	60	240			

ZOHX 12/16/20 25/32 ZCC

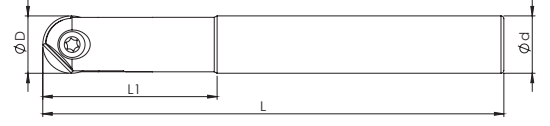

Kesici Uç Uyumluluğu Insert Suitability	Stok / Stock	Takım Ölçüleri / Dimension (mm)				Uç Insert	Vida Screw	Anahtar Torx Key
ZCC ZOHX 12/16/20/25/32		D	d	L1	L			
ST ZOHX 12 001 ZCC	✓	12	16	45	150	ZOHX 1203	M5X0,5X10	T20
ST ZOHX 16 002 ZCC	✓	16	16	60	180	ZOHX 1604	M5X0,5X12	
ST ZOHX 20 003 ZCC	✓	20	20	60	200	ZOHX 2005	M5X0,5X17	
ST ZOHX 25 004 ZCC	✓	25	25	60	250	ZOHX 2506	M6X0,75X20	
ST ZOHX 32 005 ZCC	✓	32	32	60	250	ZOHX 3207	M8X1X25	

XPHT 25/32 ZCC

NEW

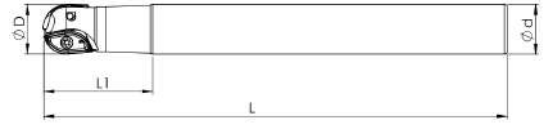





Kesici Uç Uyumluluğu Insert Suitability	Stok / Stock	Takım Ölçüleri / Dimension (mm)				Uç Insert	Vida Screw	Anahtar Torx Key
ZCC XPHT 25/32		D	d	L1	L			
ST XPHT 32 002 ZCC	✓	32	32	70	300	XPHT 1606	M5X0,5X13	T20
ST XPHT 25 003 ZCC	✓	25	25	60	200	XPHT R12,5	M4X0,5X9	T15

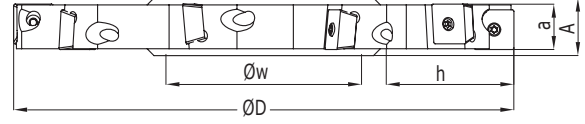

FREZELEME TAKIMLARI FACE MILLING



CCMT 06/09/12 ISO DISK FREZE

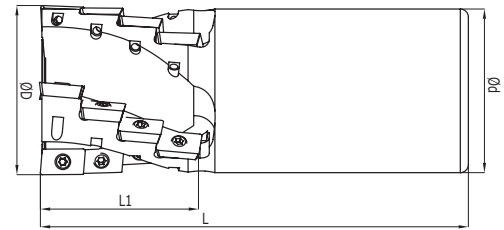

Kesici Uç Uyumluluğu Insert Suitability	Stok / Stock	Takım Ölçüleri / Dimension (mm)						Uç Insert	Vida Screw	Anahtar Torx Key
		D	a	A	Z	h	w			
ISO CCMT 06/09/12 ISO										
DKF 001 ISO	✓	80	8	12	10	16	27	CC.. 0602..	M2,5X6	T08
DKF 002 ISO	✓	100	8	12	12	24	32			
DKF 003 ISO	✓	125	8	12	14	34	40			
DKF 004 ISO	✓	160	8	12	16	50	40			
DKF 005 ISO	✓	80	10	14	10	16	27			
DKF 006 ISO	✓	100	10	14	12	24	32			
DKF 007 ISO	✓	125	10	14	14	34	40			
DKF 008 ISO	✓	160	10	14	16	50	40			
DKF 009 ISO	✓	80	12	16	8	16	27	CC.. 09T3..	M3,5X9	T15
DKF 010 ISO	✓	100	12	16	10	24	32			
DKF 011 ISO	✓	125	12	16	12	34	40			
DKF 012 ISO	✓	160	12	16	14	50	40			
DKF 013 ISO	✓	80	14	18	8	16	27			
DKF 014 ISO	✓	100	14	18	10	24	32			
DKF 015 ISO	✓	125	14	18	12	34	40			
DKF 016 ISO	✓	160	14	18	14	50	40			
DKF 017 ISO	✓	80	16	20	8	16	27	CC.. 1204..	M5X12	T20
DKF 018 ISO	✓	100	16	20	8	24	32			
DKF 019 ISO	✓	125	16	20	10	34	40			
DKF 020 ISO	✓	160	16	20	12	50	40			

APKT 1003 ISO HELİSEL FREZE



Kesici Uç Uyumluluğu Insert Suitability	Stok / Stock	Takım Ölçüleri / Dimension (mm)						Uç Insert	Vida Screw	Anahtar Torx Key
		Inter Cooland	D	Z	L	L1	d			
ISO APKT 1003										
S HF AP.. 10 001 ISO	✓	✓	20	6	110	27	20	AP..1003	M2,5X7	T08
S HF AP.. 10 002 ISO	✓	✓	25	8	120	36	25			
S HF AP.. 10 003 ISO	✓	✓	32	15	120	45	32			
S HF AP.. 10 004 ISO	✓	✓	40	18	130	54	32			

LNKT 1206 ZCC

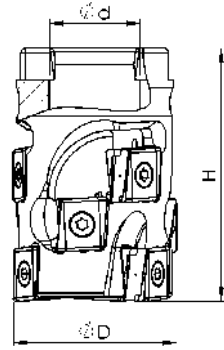

Kesici Uç Uyumluluğu Insert Suitability	Stok / Stock		Takım Ölçüleri / Dimension (mm)				Uç Insert	Vida Screw	Anahtar Torx Key
		Inter Cooland	D	Z	H	d			
ZCC LNKT 1205									
TK HF LNKT 12 001 ZCC	✓	✓	40	9	61	22	LNKT 1206	M4X11	T15
TK HF LNKT 12 002 ZCC	✓	✓	50	16	67	27			
TK HF LNKT 12 003 ZCC	✓	✓	50	16	67	22			

AP.. 1604 ISO HELİSEL FREZE

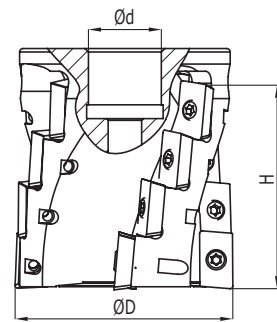

Kesici Uç Uyumluluğu Insert Suitability	Stok / Stock		Takım Ölçüleri / Dimension (mm)				Uç Insert	Vida Screw	Anahtar Torx Key
		Inter Cooland	D	Z	H	d			
ISO AP..1604									
TK HF 001 ISO	✓	X	50	12	42	22	AP..1604..	M3.5X8	T15
TK HF 002 ISO	✓	X	63	16	56	22			
TK HF 003 ISO	✓	X	80	25	70	27			

TCMT 11/16 ISO HAVŞA MATKABI

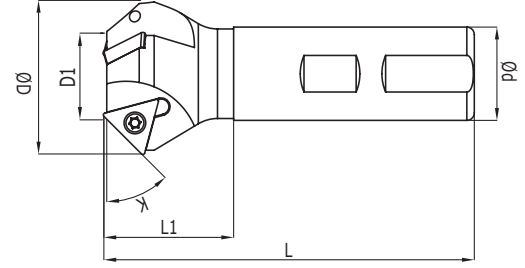

Kesici Uç Uyumluluğu Insert Suitability	Stok / Stock	Takım Ölçüleri / Dimension (mm)							Uç Insert	Vida Screw	Anahtar Torx Key
		K	D	Z	D1	d	L	L1			
ISO TCMT 11/16											
HM 001 ISO	✓	45°	15	1	4	16	L100	35	TC..11	M2,5X7	T8
HM 002 ISO	✓	45°	25	2	14	16	L120	35			
HM 003 ISO	✓	45°	30	2	16	16	L100	35			
HM 004 ISO	✓	45°	35	3	21	16	L100	35			
HM 005 ISO	✓	45°	23	3	5	16	L100	35			
HM 006 ISO	✓	45°	31	1	10	16	L100	35	TC..16	M3,5X8	T15
HM 007 ISO	✓	45°	35	2	14	20	L100	35			
HM 009 ISO	✓	45°	43	2	22	25	L100	35			
HM 010 ISO	✓	45°	50	3	30	25	L100	35			
HM 012 ISO	✓	60°	20	3	6	16	L100	35			
HM 013 ISO	✓	60°	35	1	20	20	L100	35	TC..16	M3,5X8	T15
HM 014 ISO	✓	60°	40	2	24	25	L100	35			

CCMT 06/09 ISO T FREZE

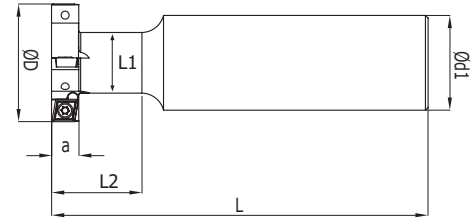

Kesici Uç Uyumluluğu Insert Suitability	Stok / Stock	Takım Ölçüleri / Dimension (mm)							Uç Insert	Vida Screw	Anahtar Torx Key
		D	Z	a	L	L1	L2	d1			
ISO CCMT 06/09											
TF 000 ISO	✓	14	2	7	85	7	15	16	CC.. 0602..	M2,5X7	T08
TF 001 ISO	✓	17	2	8	85	8	20	16			
TF 002 ISO	✓	20	2	9	85	10	20	16			
TF 003 ISO	✓	21	2	9	85	10	20	16			
TF 004 ISO	✓	24	2	10	100	12	25	20			
TF 005 ISO	✓	25	2	11	100	12	25	25			
TF 006 ISO	✓	25	4	12	100	12	25	25			
TF 007 ISO	✓	32	4	8	100	16	25	25			
TF 008 ISO	✓	32	4	10	100	16	30	25			
TF 009 ISO	✓	63	8	8	125	31	40	32			
TF 010 ISO	✓	30	2	12	100	16	30	25	CC.. 09T3..	M3,5X8	T15
TF 011 ISO	✓	32	2	14	100	16	30	25			
TF 012 ISO	✓	40	4	16	120	18	30	32			
TF 013 ISO	✓	40	4	18	120	18	30	32			
TF 014 ISO	✓	32	2	12	100	16	30	25			
TF 015 ISO	✓	40	4	12	120	18	30	32			
TF 016 ISO	✓	50	4	12	120	18	30	32			
TF 017 ISO	✓	50	4	16	120	18	30	32			
TF 018 ISO	✓	42	4	8	120	18	30	25			
TF 019 (L) ISO	✗	32	4	8,5	120	18	30	20			
TF 020 (R) ISO	✗	32	4	8,5	120	18	30	20	CC.. 09T3..	M3,5X8	T15
TF 022 ISO	✓	17	2	9	85	9	20	16	CC.. 0602..	M2,5X7	T08

Lütfen Sipariş vermeden önce stok durumunu sorunuz.
Please ask before ordering, stock status.

L: Sol / Left

R: Sağ / Right

✓ Stokta / In Stock

✗ Stokta Yok / Non Stock

DCMT 11 55° ISO KIRLANGIÇ FREZE

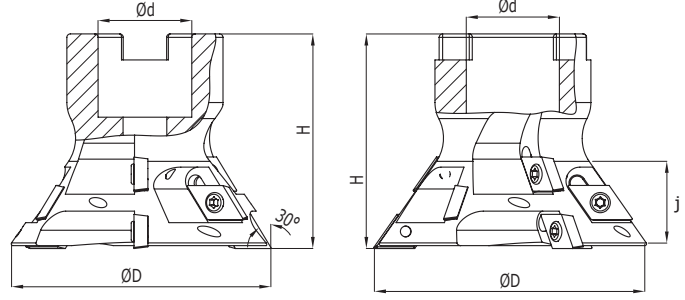

Kesici Uç Uyumluluğu Insert Suitability	Stok / Stock		Takım Ölçüleri / Dimension (mm)						Uç Insert	Vida Screw	Anahtar Torx Key
	ISO	Inter Coolant	D	Z	H	d	j	K			
TK KRF 55 001 ISO	✓	X	80	9	61	27	24	55°	DCMT 11T3	M3,5X11	T15
TK KRF 60 002 ISO	✓	X	80	9	61	27	26	60°			
TK KRF 60 003 ISO	✓	X	50	4	45	22	9	60°			



TARAMA KAFALARI FACE MILLING

90° TPKN 16 ISO

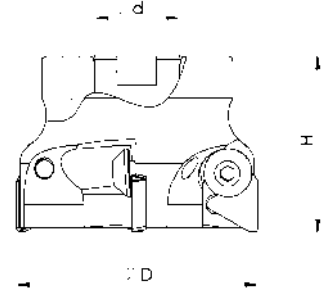
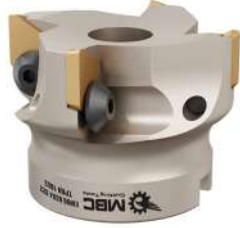

Kesici Uç Uyumluluğu Insert Suitability	Stok / Stock		Takım Ölçüleri / Dimension (mm)				Uç Insert	Vida Screw	Anahtar Allen Key
		Inter Cooland	D	Z	H	d			
ISO TPKN 1603									
TK TPKN 16 001 ISO	✓	X	50	3	41	22	TPKN 16	M6X0,75	A4
TK TPKN 16 002 ISO	✓	X	63	4	48	22			
TK TPKN 16 003 ISO	✓	X	80	5	52	32			
TK TPKN 16 004 ISO	✓	X	100	6	52	32			

90° TPKN 22 ISO

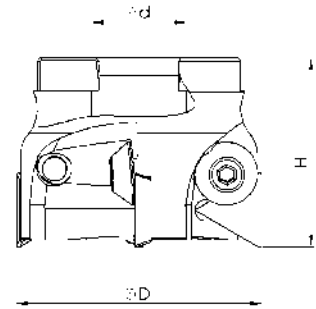

Kesici Uç Uyumluluğu Insert Suitability	Stok / Stock		Takım Ölçüleri / Dimension (mm)				Uç Insert	Vida Screw	Anahtar Allen Key
		Inter Cooland	D	Z	H	d			
ISO TP.. 2204									
TK TPKN 22 001 ISO	✓	X	63	3	48	22	TPKN 22	M8x1	A5
TK TPKN 22 002 ISO	✓	X	80	4	52	27			
TK TPKN 22 003 ISO	✓	X	80	4	52	32			
TK TPKN 22 004 ISO	✓	X	100	5	52	32			
TK TPKN 22 005 ISO	✓	X	125	6	62	32			
TK TPKN 22 006 ISO	✓	X	125	6	62	40			
TK TPKN 22 007 ISO	✓	X	160	7	62	40			
TK TPKN 22 008 ISO	✓	X	200	8	62	60			
TK TPKN 22 009 ISO	✓	X	250	10	62	60			

90° AP.. 1003 ISO

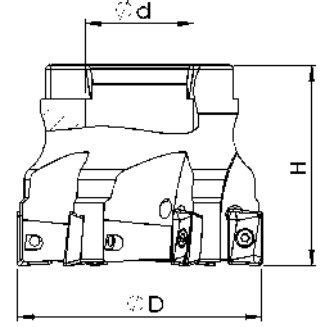

Kesici Uç Uyumluluğu Insert Suitability	Stok / Stock		Takım Ölçüleri / Dimension (mm)				Uç İnsert	Vida Screw	Anahtar Torx Key
		Inter Cooland	D	Z	H	d			
ISO AP.. 1003									
TK AP..10 001 ISO	✓	✓	40	5	45	16	AP..1003	M2,5X7	T08
TK AP..10 002 ISO	✓	✓	50	6	45	22			
TK AP..10 003 ISO	✓	✓	63	7	45	22			
TK AP..10 004 ISO	✓	✓	80	8	52	27			
TK AP..10 005 ISO	✓	✓	100	9	52	32			

90° APKT 16 ISO

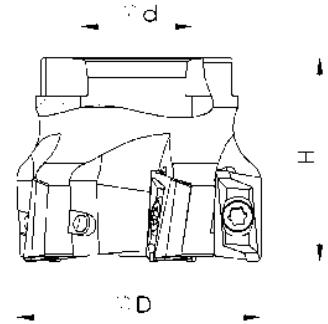

Kesici Uç Uyumluluğu Insert Suitability	Stok / Stock		Takım Ölçüleri / Dimension (mm)				Uç İnsert	Vida Screw	Anahtar Torx Key
		Inter Cooland	D	Z	H	d			
ISO APKT 1604									
TK AP..16 001 ISO	✓	✓	40	4	45	16	AP..1604	M3,5X11	T15
TK AP..16 002 ISO	✓	✓	50	4	45	22			
TK AP..16 003 ISO	✓	✓	50	5	45	22			
TK AP..16 004 ISO	✓	✓	63	5	45	22			
TK AP..16 005 ISO	✓	✓	80	6	52	27			
TK AP..16 006 ISO	✓	✓	80	6	52	32			
TK AP..16 007 ISO	X	✓	80	7	52	27			
TK AP..16 008 ISO	✓	✓	100	8	52	32			
TK AP..16 009 ISO	X	✓	100	9	52	32			
TK AP..16 010 ISO	✓	X	125	8	62	40			
TK AP..16 011 ISO	✓	X	125	9	62	40			
TK AP..16 012 ISO	✓	X	160	10	62	40			
TK AP..16 013 ISO	✓	X	200	12	62	60			
TK AP..16 014 ISO	✓	X	250	14	62	60			

90° VCGT 2205 ISO

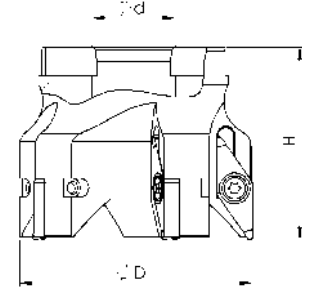
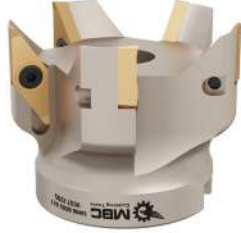

Kesici Uç Uyumluluğu Insert Suitability	Stok / Stock		Takım Ölçüleri / Dimension (mm)				Uç Insert	Vida Screw	Anahtar Torx Key
		Inter Cooland	D	Z	H	d			
ISO VCGT 2205									
TK VCGT 22 001 ISO	✓	✓	50	3	50	22	VCGT 220530	M5X12	T20
TK VCGT 22 002 ISO	✓	✓	63	3	60	22			
TK VCGT 22 003 ISO	✓	✓	63	4	50	22			
TK VCGT 22 004 ISO	✓	✓	80	5	52	27			

90° TPKT 2205 DRCP

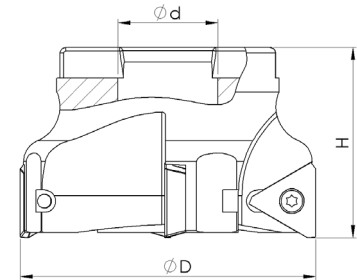

Kesici Uç Uyumluluğu Insert Suitability	Stok / Stock		Takım Ölçüleri / Dimension (mm)				Uç Insert	Vida Screw	Anahtar Torx Key
		Inter Cooland	D	Z	H	d			
DRCP TPKT 22									
TK TPKT 22 001 DRCP	✓	X	63	3	42	22	TPKT 22	M4,5X12	T20
TK TPKT 22 002 DRCP	✓	X	80	4	52	27			
TK TPKT 22 003 DRCP	✓	X	100	5	52	32			
TK TPKT 22 004 DRCP	✓	X	125	6	62	40			
TK TPKT 22 005 DRCP	✓	X	160	7	62	40			

90° ANKX 09 I

NEW

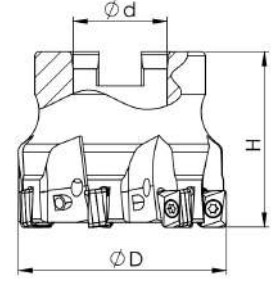

Kesici Uç Uyumluluğu Insert Suitability	Stok / Stock		Takım Ölçüleri / Dimension (mm)				Uç İnsert	Vida Screw	Anahtar Torx Key
		Inter Cooland	D	Z	H	d			
I ANKX 09									
TK ANKX 09 002 I	✓	✓	63	7	40	22	ANKX 09	M3X8	T10

90° AN.. 1205 I

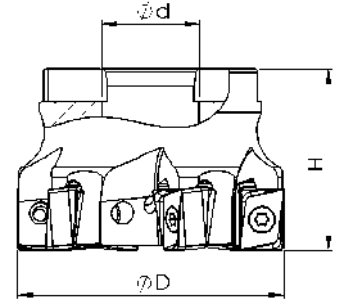

Kesici Uç Uyumluluğu Insert Suitability	Stok / Stock		Takım Ölçüleri / Dimension (mm)				Uç İnsert	Vida Screw	Anahtar Torx Key
		Inter Cooland	D	Z	H	d			
I ANKX 1205									
TK ANKX 12 001 I	✓	✓	50	5	40	22	AN..1205	M4X14	T15
TK ANKX 12 002 I	✓	✓	63	6	45	22			
TK ANKX 12 003 I	✓	✓	80	7	52	27			
TK ANKX 12 004 I	✓	✓	100	8	52	32			
TK ANKX 12 005 I	✓	X	125	10	62	40			

90° WCGT 0402 I

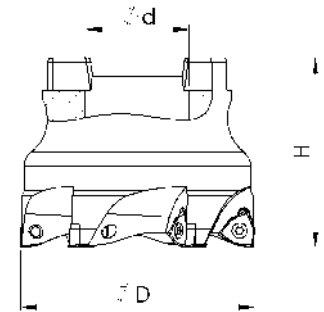

Kesici Uç Uyumluluğu Insert Suitability	Stok / Stock		Takım Ölçüleri / Dimension (mm)				Uç İnsert	Vida Screw	Anahtar Torx Key
		Inter Cooland	D	Z	H	d			
I WCGT 0402									
TK WCGT 04 001 I	✓	✓	50	6	40	22	WCGT 0402	M2,5X7	T8
TK WCGT 04 002 I	✓	✓	63	7	40	22			

90° TP.. 1003 I

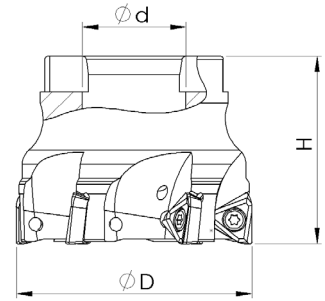

Kesici Uç Uyumluluğu Insert Suitability	Stok / Stock		Takım Ölçüleri / Dimension (mm)				Uç İnsert	Vida Screw	Anahtar Torx Key
		Inter Cooland	D	Z	H	d			
i TPKT 1003									
TK TPKT 10 001 I	✓	✓	40	5	40	16	TP..1003	M3X8	T10
TK TPKT 10 002 I	✓	✓	50	6	40	22			
TK TPKT 10 003 I	✓	✓	63	7	40	22			

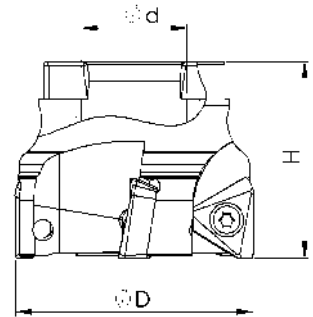

90° TD.. 1505 I



Kesici Uç Uyumluluğu Insert Suitability	Stok / Stock		Takım Ölçüleri / Dimension (mm)				Uç İnsert	Vida Screw	Anahtar Torx Key
		Inter Cooland	D	Z	H	d			
i TDKT 1505									
TK TDKT 15 001 I	✓	X	50	4	40	22	TDKT 1505	M5X12	T20
TK TDKT 15 002 I	✓	X	63	5	40	22			

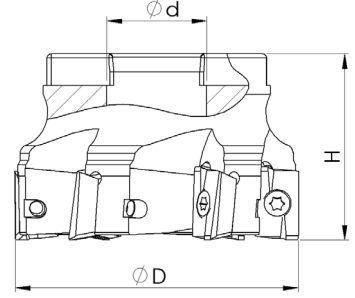

90° AD.. 1505 I

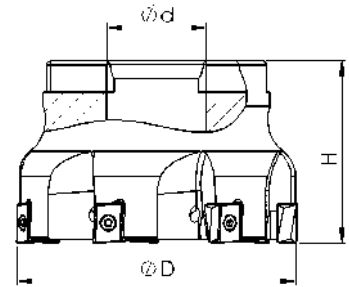

Kesici Uç Uyumluluğu Insert Suitability	Stok / Stock		Takım Ölçüleri / Dimension (mm)				Uç Insert	Vida Screw	Anahtar Torx Key
		Inter Cooland	D	Z	H	d			
I AD.. 1505									
TK AD.. 15 001 I	✓	✓	40	4	40	16	ADKT 1505	M4X11	T15
TK AD.. 15 002 I	✓	✓	50	5	40	22			
TK AD.. 15 003 I	✓	✓	63	6	40	22			
TK AD.. 15 004 I	✓	✓	80	7	52	27			
TK AD.. 15 005 I	✓	✓	100	8	52	32			

90° LN.. 0804 I



Kesici Uç Uyumluluğu Insert Suitability	Stok / Stock		Takım Ölçüleri / Dimension (mm)				Uç Insert	Vida Screw	Anahtar Torx Key
		Inter Cooland	D	Z	H	d			
I LNMT 0804									
TK LNMT 08 001 I	✓	✓	50	5	40	22	LNMT 0804	M2,5X8	T8
TK LNMT 08 002 I	✓	✓	63	7	40	22			

90° WN.. 0705 I

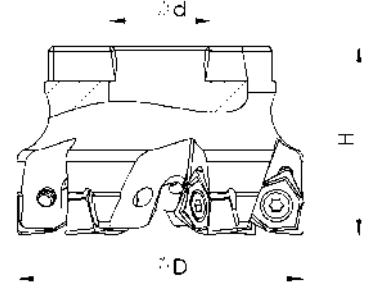

Kesici Uç Uyumluluğu Insert Suitability	Stok / Stock		Takım Ölçüleri / Dimension (mm)				Uç Insert	Vida Screw	Anahtar Torx Key
		Inter Coolant	D	Z	H	d			
I WNUMU 0705									
TK WNUMU 07 001 I	✓	✓	63	6	40	22	WNUMU 0705	M4X11	T15
TK WNUMU 07 002 I	✓	✓	80	7	50	27			
TK WNUMU 07 003 I	✓	✓	100	8	50	32			

90° LNGX 1307 WLTR

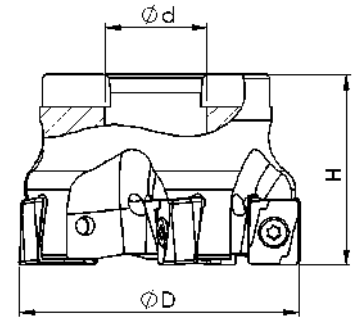

Kesici Uç Uyumluluğu Insert Suitability	Stok / Stock		Takım Ölçüleri / Dimension (mm)				Uç Insert	Vida Screw	Anahtar Torx Key
		Inter Coolant	D	Z	H	d			
WLTR LNGX 1307									
TK LNGX 13 001 WLTR	X	✓	50	3	40	22	LNGX 1307..	M4X14	T15
TK LNGX 13 002 WLTR	X	✓	63	4	45	22			
TK LNGX 13 003 WLTR	X	✓	80	5	52	32			
TK LNGX 13 004 WLTR	✓	✓	100	8	52	32			
TK LNGX 13 005 WLTR	X	X	125	7	62	40			
TK LNGX 13 006 WLTR	✓	X	160	8	62	40			
TK LNGX 13 007 WLTR	✓	✓	80	7	52	27			
TK LNGX 13 008 WLTR	✓	✓	50	4	40	22			
TK LNGX 13 009 WLTR	✓	✓	63	5	45	22			
TK LNGX 13 010 WLTR	✓	X	125	10	62	40			

90° LNHU 1306 WLTR

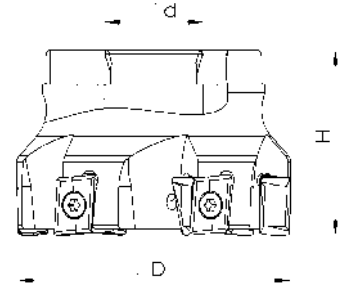

Kesici Uç Uyumluluğu Insert Suitability	Stok / Stock		Takım Ölçüleri / Dimension (mm)				Uç Insert	Vida Screw	Anahtar Torx Key
		Inter Cooland	D	Z	H	d			
WLTR LNHU 1306									
TK LNHU 13 001 WLTR	✓	✓	40	4	40	16	LNHU 1306	M4X11	T15
TK LNHU 13 002 WLTR	✓	✓	50	5	40	22			
TK LNHU 13 003 WLTR	✓	✓	63	6	40	22			
TK LNHU 13 004 WLTR	✓	✓	80	7	52	27			
TK LNHU 13 005 WLTR	✓	✓	100	9	52	32			

90° ADMT 1204 WLTR

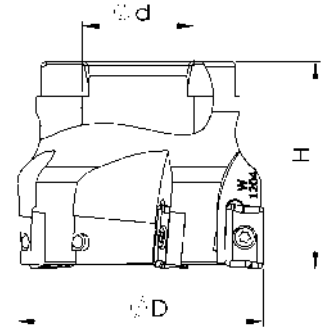

Kesici Uç Uyumluluğu Insert Suitability	Stok / Stock		Takım Ölçüleri / Dimension (mm)				Uç Insert	Vida Screw	Anahtar Torx Key
		Inter Cooland	D	Z	H	d			
WLTR ADMT 1204									
TK ADMT 12 001 WLTR	✓	X	40	4	40	16	ADMT 1204..	M3X9	T11
TK ADMT 12 002 WLTR	✓	X	50	5	45	22			
TK ADMT 12 003 WLTR	✓	X	63	6	45	22			

90° P2840 WLTR

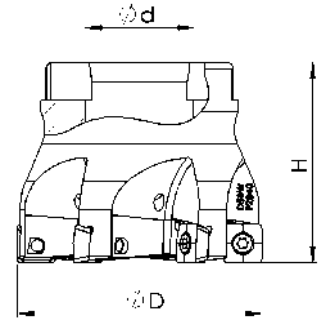

Kesici Uç Uyumluluğu Insert Suitability	Stok / Stock		Takım Ölçüleri / Dimension (mm)				Uç Insert	Vida Screw	Anahtar Torx Key
		Inter Cooland	D	Z	H	d			
WLTR P2840									
TK P2840 63 001 WLTR	✓	✓	40	4	40	16	P-2840	M3,5X8	T15
TK P2840 63 002 WLTR	✓	✓	40	5	40	22			

90° SPMT 1204 WLTR

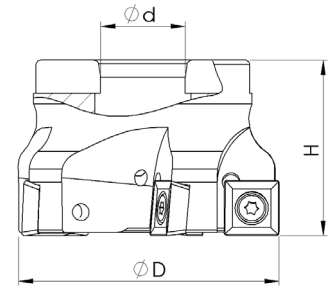

Kesici Uç Uyumluluğu Insert Suitability	Stok / Stock		Takım Ölçüleri / Dimension (mm)				Uç Insert	Vida Screw	Anahtar Torx Key
		Inter Cooland	D	Z	H	d			
WLTR SPMT 1204									
TK SPMT 12 002 ISO	✓	✓	50	4	45	22	SPMT 1204	M4,5X12	T20
TK SPMT 12 003 ISO	✓	✓	63	5	50	22			
TK SPMT 12 004 ISO	✓	✓	80	6	50	27			

90° LNMX 1006/1510 KRLY

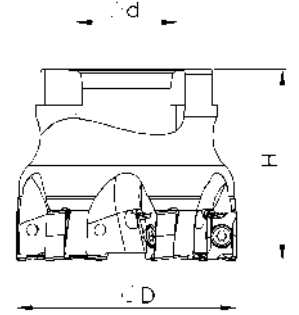

Kesici Uç Uyumluluğu Insert Suitability	Stok / Stock		Takım Ölçüleri / Dimension (mm)				Uç Insert	Vida Screw	Anahtar Torx Key
		Inter Cooland	D	Z	H	d			
KRLY LNMX 1006/1510									
TK LNMX 10 001 KRLY	✓	✓	40	4	40	16	LNMX 1006..	M3X10	T10
TK LNMX 10 002 KRLY	✓	✓	40	5	40	16			
TK LNMX 10 003 KRLY	✓	✓	50	6	40	22			
TK LNMX 15 004 KRLY	✓	✓	50	4	40	22	LNMX 1510..	M4X14	T15
TK LNMX 15 005 KRLY	✓	✓	63	6	40	22			
TK LNMX 15 006 KRLY	✓	✓	80	7	52	27			
TK LNMX 15 007 KRLY	✓	✓	100	8	52	32			
TK LNMX 15 008 KRLY	✓	✗	125	10	62	40			
TK LNMX 15 009 KRLY	✓	✗	160	12	62	40			

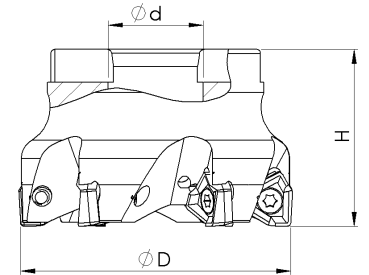

90° XNKT 0805 KRLY



Kesici Uç Uyumluluğu Insert Suitability	Stok / Stock		Takım Ölçüleri / Dimension (mm)				Uç Insert	Vida Screw	Anahtar Torx Key
		Inter Cooland	D	Z	H	d			
KRLY XNKT 0805									
TK XNKT 08 001 KRLY	✓	✓	40	4	40	16	XNKT 0805	M4X10	T15
TK XNKT 08 002 KRLY	✓	✓	50	5	45	22			
TK XNKT 08 003 KRLY	✓	✓	63	6	45	22			
TK XNKT 08 004 KRLY	✓	✓	80	7	50	27			
TK XNKT 08 005 KRLY	✓	✓	100	8	50	32			

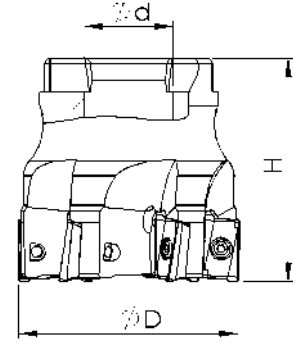

90° APMT 11T3 KRLY



Kesici Uç Uyumluluğu Insert Suitability	Stok / Stock		Takım Ölçüleri / Dimension (mm)				Uç Insert	Vida Screw	Anahtar Torx Key
		Inter Cooland	D	Z	H	d			
KRLY APMT 11T3									
TK APMT 11 000 KRLY	✓	✓	40	5	40	16	APMT 11T3	M2,5X7	T8
TK APMT 11 001 KRLY	✓	✓	40	6	40	16			
TK APMT 11 002 KRLY	✓	✓	50	6	40	22			
TK APMT 11 003 KRLY	✓	✓	63	7	40	22			

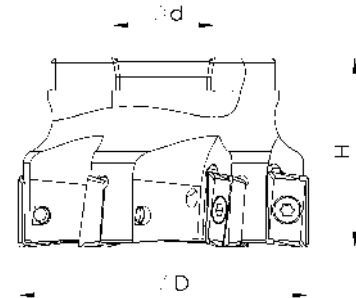

90° APMT 1604 KRLY



Kesici Uç Uyumluluğu Insert Suitability	Stok / Stock		Takım Ölçüleri / Dimension (mm)				Uç Insert	Vida Screw	Anahtar Torx Key
		Inter Cooland	D	Z	H	d			
KRLY APMT 1604									
TK APMT 16 001 KRLY	✓	✓	50	5	40	22	APMT 1604	M4X11	T15
TK APMT 16 003 KRLY	✓	✓	63	6	40	22			
TK APMT 16 004 KRLY	✓	✓	80	7	40	27			
TK APMT 16 005 KRLY	✓	✓	100	8	52	32			

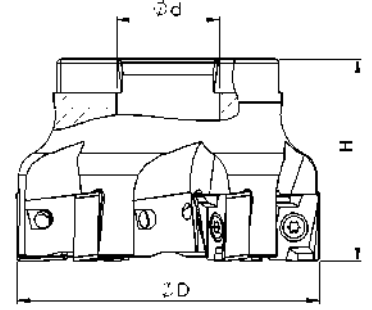

90° LNGU 1607 PRMT

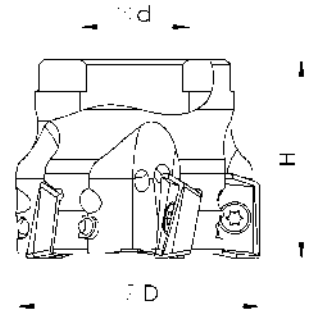

Kesici Uç Uyumluluğu Insert Suitability	Stok / Stock		Takım Ölçüleri / Dimension (mm)				Uç Insert	Vida Screw	Anahtar Torx Key
		Inter Cooland	D	Z	H	d			
PRMT LNGU 1607									
TK LNGU 16 001 PRMT	✓	✓	63	4	45	22	LNGU 1607..	M5X15	T20
TK LNGU 16 002 PRMT	✓	✓	80	4	50	27			
TK LNGU 16 003 PRMT	✓	✓	100	5	50	32			
TK LNGU 16 004 PRMT	✓	✓	63	5	40	22			
TK LNGU 16 005 PRMT	✓	✓	80	6	50	27			
TK LNGU 16 006 PRMT	✗	✓	100	7	50	32			
TK LNGU 16 007 PRMT	✗	✗	125	8	62	40			
TK LNGU 16 008 PRMT	✗	✗	160	8	62	40			

90° ADMX 1606 PRMT



Kesici Uç Uyumluluğu Insert Suitability	Stok / Stock		Takım Ölçüleri / Dimension (mm)				Uç Insert	Vida Screw	Anahtar Torx Key
		Inter Cooland	D	Z	H	d			
PRMT ADMX 1606									
TK ADMX 16 001 PRMT	✓	✗	50	4	40	22	ADMX 1606	M4X10	T15
TK ADMX 16 002 PRMT	✓	✗	50	5	40	22			
TK ADMX 16 003 PRMT	✓	✗	80	7	50	27			
TK ADMX 16 004 PRMT	✓	✗	100	6	52	32			
TK ADMX 16 005 PRMT	✓	✗	100	8	52	32			

90° XN..0403 SCO-VNDRT

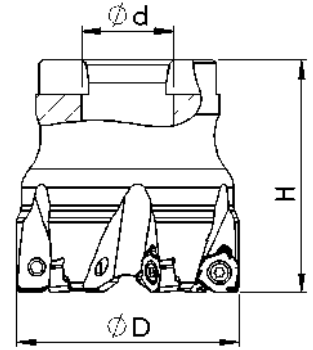

Kesici Uç Uyumluluğu Insert Suitability	Stok / Stock		Takım Ölçüleri / Dimension (mm)				Uç İnsert	Vida Screw	Anahtar Torx Key
		Inter Cooland	D	Z	H	d			
SCO – VNDRT XN..0403									
TK XNEX 04 001 SC-VD	✓	✓	40	4	40	16	XNEX 0403	M2,5X7	T8
TK XNEX 04 002 SC-VD	✓	✓	50	7	40	22			

90° LNGX 1205 VNDRT

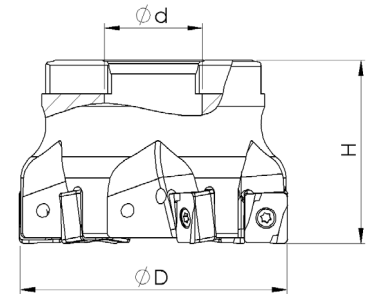
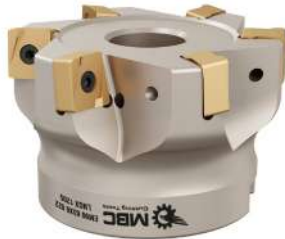

Kesici Uç Uyumluluğu Insert Suitability	Stok / Stock		Takım Ölçüleri / Dimension (mm)				Uç İnsert	Vida Screw	Anahtar Torx Key
		Inter Cooland	D	Z	H	d			
PRMT/VNDRT LNGX 1205									
TK LNGX 12 001 VNDRT	✓	✓	40	4	40	16	LNGX 1205..	M3,5X11	T15
TK LNGX 12 002 VNDRT	✓	✓	50	5	40	22			
TK LNGX 12 003 VNDRT	✓	✓	63	6	40	22			
TK LNGX 12 004 VNDRT	✓	✓	80	5	40	27			
TK LNGX 12 005 VNDRT	✓	✓	100	6	40	32			

90° ANHG 1005 VNDRT

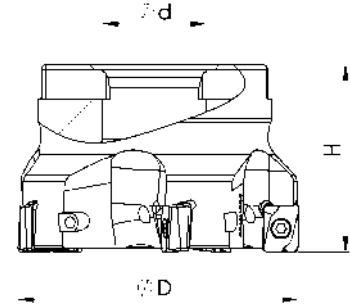

Kesici Uç Uyumluluğu Insert Suitability	Stok / Stock		Takım Ölçüleri / Dimension (mm)				Uç Insert	Vida Screw	Anahtar Torx Key
		Inter Cooland	D	Z	H	d			
VNDRT ANHG 1005									
TK ANHG 10 001 VNDRT	✓	✓	40	4	40	16	ANHG 1005	M3X10	T10
TK ANHG 10 002 VNDRT	✓	✓	50	5	40	22			
TK ANHG 10 003 VNDRT	✓	✓	63	5	40	22			
TK ANHG 10 004 VNDRT	✓	✓	63	7	40	22			
TK ANHG 10 005 VNDRT	✓	✓	80	6	40	27			
TK ANHG 10 006 VNDRT	✓	✓	100	7	40	32			
TK ANHG 10 007 VNDRT	✓	✓	100	8	40	32			

90° XNEX 0806 VNDRT

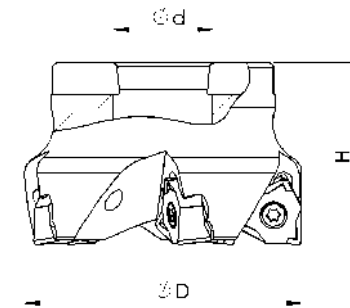

Kesici Uç Uyumluluğu Insert Suitability	Stok / Stock		Takım Ölçüleri / Dimension (mm)				Uç Insert	Vida Screw	Anahtar Torx Key
		Inter Cooland	D	Z	H	d			
SCO-VNDR XNEX 0806									
TK XNEX 08 002 SC-VD	✓	✓	50	4	40	22	XNEX 0806	M4X11	T15
TK XNEX 08 003 SC-VD	✓	✓	63	5	40	22			
TK XNEX 08 004 SC-VD	✓	✓	80	7	50	27			
TK XNEX 08 005 SC-VD	✓	✓	100	8	62	32			
TK XNEX 08 006 SC-VD	✓	X	160	12	62	40			

90° ANHG 1607 VNDRT

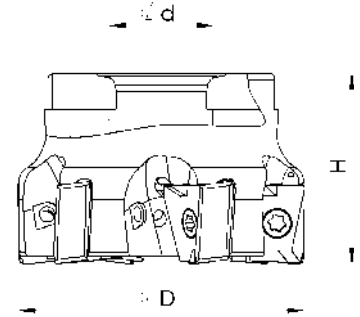

Kesici Uç Uyumluluğu Insert Suitability	Stok / Stock		Takım Ölçüleri / Dimension (mm)				Uç Insert	Vida Screw	Anahtar Torx Key
		Inter Cooland	D	Z	H	d			
VNDRT ANHG 1607									
TK ANHG 16 001 VNDRT	✓	✓	50	4	40	22	ANHG 1607	M4X14	T15
TK ANHG 16 002 VNDRT	✓	✓	63	4	40	22			
TK ANHG 16 003 VNDRT	✓	✓	63	6	40	22			
TK ANHG 16 004 VNDRT	✓	✓	80	5	50	27			
TK ANHG 16 005 VNDRT	✓	✓	80	7	50	27			
TK ANHG 16 006 VNDRT	✓	✓	100	8	50	32			

90° ANHX 1607 TT

NEW

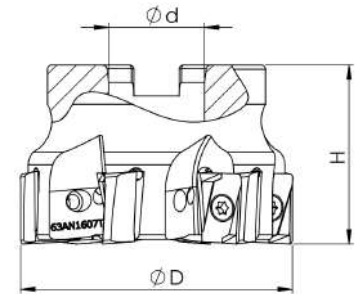

Kesici Uç Uyumluluğu Insert Suitability	Stok / Stock		Takım Ölçüleri / Dimension (mm)				Uç Insert	Vida Screw	Anahtar Torx Key
		Inter Cooland	D	Z	H	d			
TT ANHX 1607									
TK ANHX 16 001 TT	✓	✓	50	5	40	22	ANHX 1607	M4X14	T15
TK ANHX 16 002 TT	✓	✓	63	6	40	22			
TK ANHX 16 003 TT	✓	✓	80	7	50	27			
TK ANHX 16 004 TT	✓	✓	100	8	50	32			

90° YNGX 06 SNG

NEW

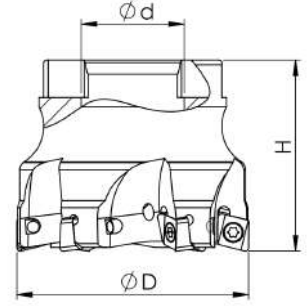

Kesici Uç Uyumluluğu Insert Suitability	Stok / Stock		Takım Ölçüleri / Dimension (mm)				Uç Insert	Vida Screw	Anahtar Torx Key
		Inter Cooland	D	Z	H	d			
TT YNGX 06									
TK YNGX 06 000 SNG	✓	✓	50	6	40	22	YNGX 0603	M3X8	T10
TK YNGX 06 001 SNG	✓	✓	63	7	40	22			
TK YNGX 06 002 SNG	✓	✓	40	5	40	16			

90° WNMU 0806 SNG

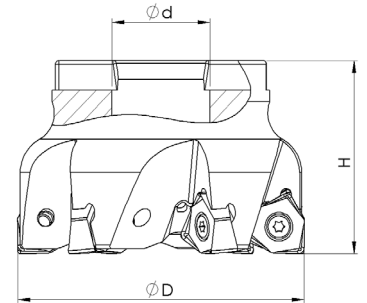



Kesici Uç Uyumluluğu Insert Suitability	Stok / Stock		Takım Ölçüleri / Dimension (mm)				Uç Insert	Vida Screw	Anahtar Torx Key
		Inter Cooland	D	Z	H	d			
SNG WNMU 0806									
TK WNMU 08 001 SNG	✓	✓	50	4	40	22	WNMU 0806	M4,5X12	T20
TK WNMU 08 002 SNG	✓	✓	52	4	40	22			
TK WNMU 08 003 SNG	✓	✓	63	4	40	22			
TK WNMU 08 004 SNG	✓	✓	63	5	40	22			
TK WNMU 08 005 SNG	✓	✓	80	6	50	27			
TK WNMU 08 006 SNG	✓	X	125	8	62	40			
TK WNMU 08 007 SNG	✓	X	160	10	62	40			
TK WNMU 08 008 SNG	✓	✓	100	7	52	32			

90° APMT 1035 SNG

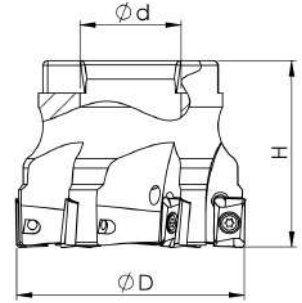

NEW

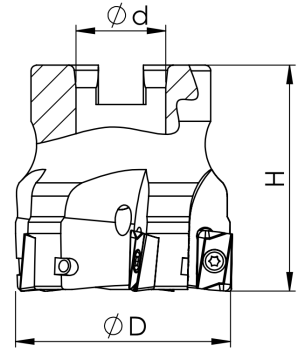

Kesici Uç Uyumluluğu Insert Suitability	Stok / Stock		Takım Ölçüleri / Dimension (mm)				Uç Insert	Vida Screw	Anahtar Torx Key
		Inter Cooland	D	Z	H	d			
SNG APMT 1035									
TK APMT 10 001 SNG	✓	✓	50	6	40	16	APMT 1035	M2,5X7	T8
TK APMT 10 002 SNG	✓	✓	63	7	40	22			

90° APMT 1135 SNG



Kesici Uç Uyumluluğu Insert Suitability	Stok / Stock		Takım Ölçüleri / Dimension (mm)				Uç Insert	Vida Screw	Anahtar Torx Key
		Inter Cooland	D	Z	H	d			
SNG APMT 1135									
TK APMT 11 001 SNG	✓	✓	40	5	40	16	APMT 1135	M2,5X7	T8
TK APMT 11 002 SNG	✓	✓	50	6	40	22			
TK APMT 11 003 SNG	✓	✓	63	7	40	22			

90° LNKT 130608 SNG

NEW

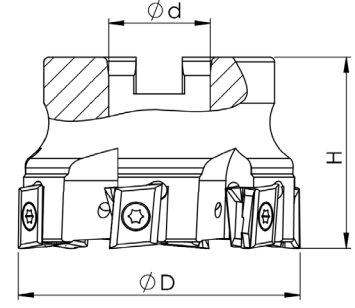

Kesici Uç Uyumluluğu Insert Suitability	Stok / Stock		Takım Ölçüleri / Dimension (mm)				Uç Insert	Vida Screw	Anahtar Torx Key
		Inter Cooland	D	Z	H	d			
SNG LNKT 1306									
TK LNKT 13 001 SNG	✓	✓	40	4	40	16	LNKT 1306	M4X14	T15
TK LNKT 13 002 SNG	✓	✓	50	5	40	22			
TK LNKT 13 003 SNG	✓	✓	63	6	40	22			
TK LNKT 13 004 SNG	✓	✓	80	7	50	27			
TK LNKT 13 005 SNG	✓	✓	100	8	50	32			
TK LNKT 13 006 SNG	✓	X	125	10	62	40			

90° 3PGX 1004 SNG

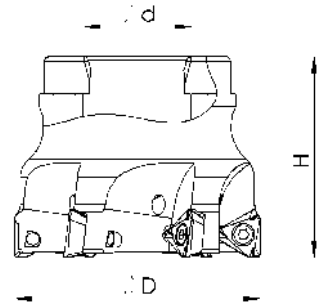

Kesici Uç Uyumluluğu Insert Suitability	Stok / Stock		Takım Ölçüleri / Dimension (mm)				Uç Insert	Vida Screw	Anahtar Torx Key
		Inter Cooland	D	Z	H	d			
SNG 3PGX 1004									
TK 3PGX 10 001 SNG	✓	✓	40	5	40	16	3PGX 1004	M3X8	T10
TK 3PGX 10 002 SNG	✓	✓	50	6	40	22			

90° 3PGX 1505 SNG

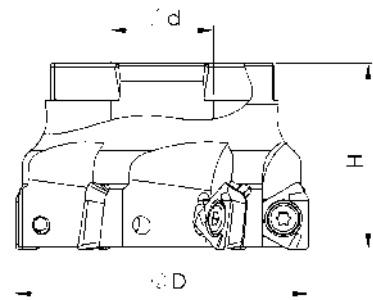

Kesici Uç Uyumluluğu Insert Suitability	Stok / Stock		Takım Ölçüleri / Dimension (mm)				Uç Insert	Vida Screw	Anahtar Torx Key
		Inter Cooland	D	Z	H	d			
SNG 3PGX 1505									
TK 3PGX 15 001 SNG	✓	✓	50	5	40	22	3PGX 1505	M4,5X12	T20
TK 3PGX 15 002 SNG	✓	✓	63	6	40	22			
TK 3PGX 15 003 SNG	✓	✓	80	7	52	27			
TK 3PGX 15 004 SNG	✓	✓	100	8	52	32			
TK 3PGX 15 005 SNG	✓	X	125	10	62	40			
TK 3PGX 15 006 SNG	✓	X	160	12	62	40			

Lütfen Sipariş vermeden önce stok durumunu sorunuz.
Please ask before ordering, stock status.

L: Sol / Left

R: Sağ / Right

✓ Stokta / In Stock

X Stokta Yok / Non Stock

90° XNMU 0606 SMTM

NEW

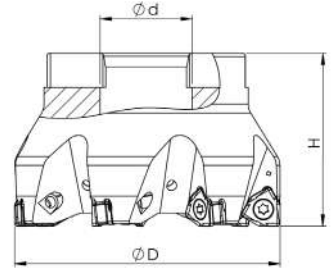

Kesici Uç Uyumluluğu Insert Suitability	Stok / Stock		Takım Ölçüleri / Dimension (mm)				Uç Insert	Vida Screw	Anahtar Torx Key
		Inter Cooland	D	Z	H	d			
SMTM XNMU 0606									
TK XNMU 06 002 SMTM	✓	✓	63	7	40	22	XNMU 06	M4X11	T15
TK XNMU 06 004 SMTM	✓	✓	80	9	50	27			

90° LOEX 1207 SCO

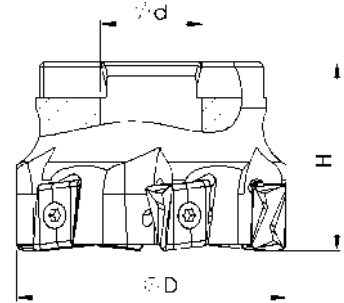

Kesici Uç Uyumluluğu Insert Suitability	Stok / Stock		Takım Ölçüleri / Dimension (mm)				Uç Insert	Vida Screw	Anahtar Torx Key
		Inter Cooland	D	Z	H	d			
SCO LOEX 1207									
TK LOEX 12 001 SCO	✓	✓	63	6	40	22	LOEX 1207	M4X11	T15
TK LOEX 12 002 SCO	✓	✓	80	7	52	27			
TK LOEX 12 003 SCO	✓	✓	100	9	52	32			

90° LDEW 1503 SCO

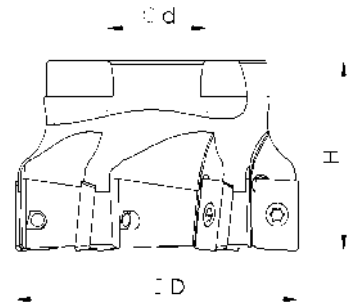

Kesici Uç Uyumluluğu Insert Suitability	Stok / Stock		Takım Ölçüleri / Dimension (mm)				Uç Insert	Vida Screw	Anahtar Torx Key
		Inter Cooland	D	Z	H	d			
SCO LDEW 1503									
TK LDEW 1503 001 SECO	✓	X	40	4	40	16	LDEW 15	M3,5X8	T15
TK LDEW 1503 002 SECO	✓	X	50	5	40	22			
TK LDEW 1503 003 SECO	✓	X	63	6	40	22			

90° XOMX 1204 SCO

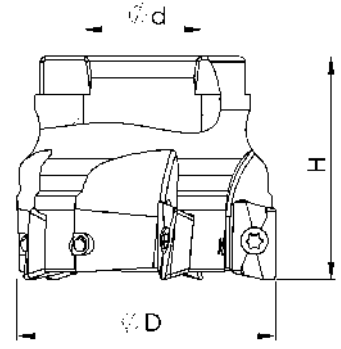

Kesici Uç Uyumluluğu Insert Suitability	Stok / Stock		Takım Ölçüleri / Dimension (mm)				Uç İnsert	Vida Screw	Anahtar Torx Key
		Inter Cooland	D	Z	H	d			
SCO XOMX 1204									
TK XOMX 12 001 SCO	✓	X	40	4	40	16	XOMX 1204	M3,5X11	T15
TK XOMX 12 002 SCO	✓	X	50	5	40	22			
TK XOMX 12 003 SCO	✓	X	63	6	40	22			
TK XOMX 12 004 SCO	✓	X	80	8	50	27			

3PKT 1505 TT

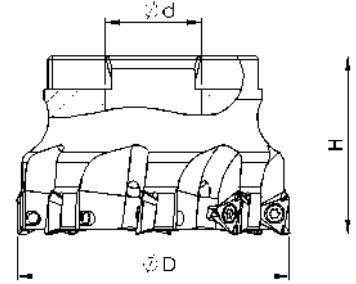

Kesici Uç Uyumluluğu Insert Suitability	Stok / Stock		Takım Ölçüleri / Dimension (mm)				Uç İnsert	Vida Screw	Anahtar Torx Key
		Inter Cooland	D	Z	H	d			
TK 3PKT 1505									
TK 3PKT 15 001 TT	✓	✓	50	4	40	22	3PKT 1505	M4,5X12	T20
TK 3PKT 15 002 TT	✓	✓	63	5	40	22			
TK 3PKT 15 003 TT	✓	✓	80	7	50	27			
TK 3PKT 15 004 TT	✓	✓	100	8	50	32			

90° APKT 1204 TT

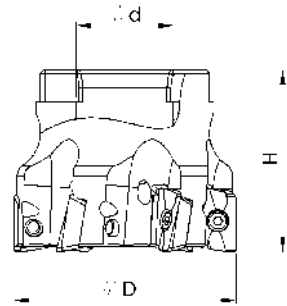

Kesici Uç Uyumluluğu Insert Suitability	Stok / Stock		Takım Ölçüleri / Dimension (mm)				Uç İnsert	Vida Screw	Anahtar Torx Key
		Inter Cooland	D	Z	H	d			
TT APKT 1204									
TK AP..12 001 TT	✓	✓	40	5	40	16	APKT 1204	M3,5X10	T15
TK AP..12 002 TT	✓	✓	50	6	40	22			
TK AP..12 003 TT	✓	✓	63	7	40	22			
TK AP..12 004 TT	✓	✓	80	8	52	27			

Lütfen Sipariş vermeden önce stok durumunu sorunuz.
Please ask before ordering, stock status.

L: Sol / Left

R: Sağ / Right

✓ Stokta / In Stock

X Stokta Yok / Non Stock

90° 3PKT 1004 TT

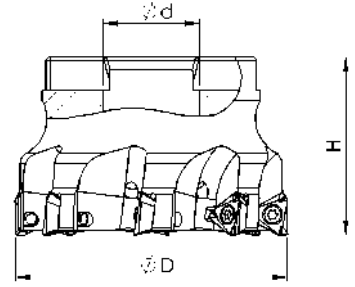

Kesici Uç Uyumluluğu Insert Suitability	Stok / Stock		Takım Ölçüleri / Dimension (mm)				Uç Insert	Vida Screw	Anahtar Torx Key
		Inter Cooland	D	Z	H	d			
TT 3PKT 1004									
TK 3PKT 10 001 TT	✓	✓	40	4	40	16	3PKT 1004	M3X8	T10
TK 3PKT 10 002 TT	✓	✓	50	5	40	22			
TK 3PKT 10 003 TT	✓	✓	63	8	40	22			

90° APMT 1135 TT

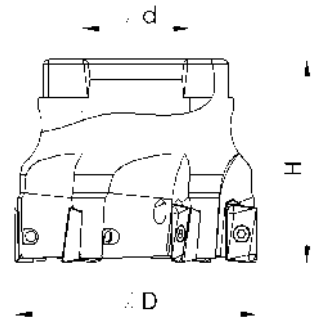

Kesici Uç Uyumluluğu Insert Suitability	Stok / Stock		Takım Ölçüleri / Dimension (mm)				Uç Insert	Vida Screw	Anahtar Torx Key
		Inter Cooland	D	Z	H	d			
TT APMT 1135									
TK APMT 1135 001	✓	✓	40	5	40	16	APMT 1135	M2,5X7	T8
TK APMT 1135 002	✓	✓	50	6	40	22			
TK APMT 1135 003	✓	✓	63	7	40	22			

90° 6NGU 0604 TT

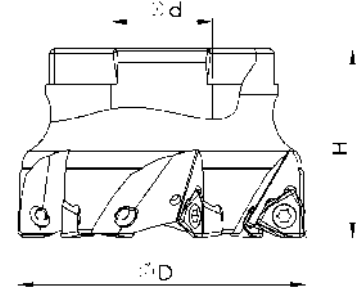

Kesici Uç Uyumluluğu Insert Suitability	Stok / Stock		Takım Ölçüleri / Dimension (mm)				Uç Insert	Vida Screw	Anahtar Torx Key
		Inter Cooland	D	Z	H	d			
TT 6NGU 0604									
TK 6NGU 06 001 TT	✓	✓	40	4	40	16	6GNU 0604	M3X8	T10
TK 6NGU 06 002 TT	✓	✓	50	5	40	22			
TK 6NGU 06 003 TT	✓	✓	63	6	40	22			

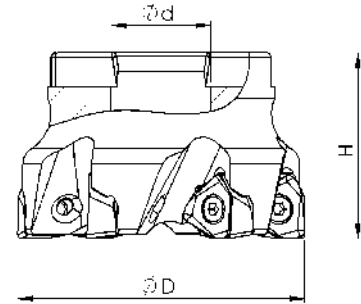

90° 6NGU 0905 TT



Kesici Uç Uyumluluğu Insert Suitability	Stok / Stock		Takım Ölçüleri / Dimension (mm)				Uç Insert	Vida Screw	Anahtar Torx Key
		Inter Cooland	D	Z	H	d			
TT 6NGU 0905									
TK 6NGU 09 001 TT	✓	✓	50	5	40	22	6GNU 0905	M4X11	T15
TK 6NGU 09 002 TT	✓	✓	63	6	40	22			
TK 6NGU 09 003 TT	✓	✓	80	7	50	27			
TK 6NGU 09 004 TT	✓	✓	100	8	50	32			
TK 6NGU 09 005 TT	✓	✓	125	10	62	40			

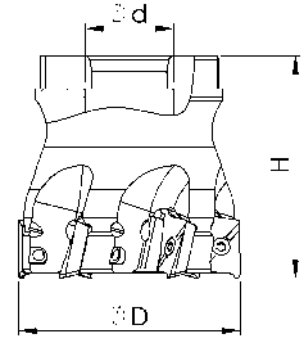

90° AOMT 1236 MTSBSH

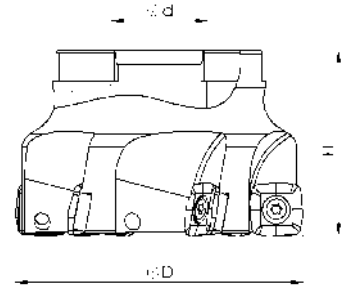

Kesici Uç Uyumluluğu Insert Suitability	Stok / Stock		Takım Ölçüleri / Dimension (mm)				Uç Insert	Vida Screw	Anahtar Torx Key
		Inter Cooland	D	Z	H	d			
MTSBSH AOMT 1236									
TK AOMT 12 001 MTSBSH	✓	✓	40	6	40	16	AOMT 1236	M2,5X7	T08
TK AOMT 12 002 MTSBSH	✓	✓	50	7	40	22			
TK AOMT 12 003 MTSBSH	✓	✓	63	8	40	22			
TK AOMT 12 004 MTSBSH	✓	✓	80	9	40	27			
TK AOMT 12 005 MTSBSH	✓	✓	100	11	40	32			

90° SOMT 12T3 MTSBSH



Kesici Uç Uyumluluğu Insert Suitability	Stok / Stock		Takım Ölçüleri / Dimension (mm)				Uç Insert	Vida Screw	Anahtar Torx Key
		Inter Cooland	D	Z	H	d			
MTSBSH SOMT 12T3									
TK SOMT 12 001 MTSBSH	✓	✓	50	4	40	22	SOMT 12T3	M3,5X11	T15
TK SOMT 12 002 MTSBSH	✓	✓	63	5	45	22			
TK SOMT 12 003 MTSBSH	✓	✓	80	6	45	27			
TK SOMT 12 004 MTSBSH	✓	✓	100	7	50	32			
TK SOMT 12 005 MTSBSH	✓	X	100	10	50	32			
TK SOMT 12 006 MTSBSH	✓	X	125	8	50	40			
TK SOMT 12 007 MTSBSH	✓	X	125	12	50	40			

90° AOMT 1848 MTSBSH

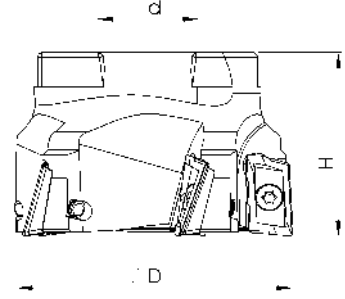

Kesici Uç Uyumluluğu Insert Suitability	Stok / Stock		Takım Ölçüleri / Dimension (mm)				Uç Insert	Vida Screw	Anahtar Torx Key
		Inter Cooland	D	Z	H	d			
MTSBSH AOMT 1848									
TK AOMT 18 001 MTSBSH	✓	X	50	5	40	22	AOMT 1848	M4X11	T15
TK AOMT 18 002 MTSBSH	✓	X	63	6	40	22			
TK AOMT 18 003 MTSBSH	✓	X	80	6	52	27			
TK AOMT 18 004 MTSBSH	✓	X	100	8	52	32			
TK AOMT 18 005 MTSBSH	✓	X	100	6	52	32			

90° XDGT 1550 MTSBSH

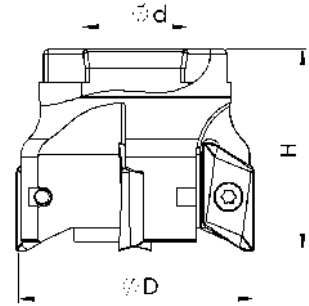

Kesici Uç Uyumluluğu Insert Suitability	Stok / Stock		Takım Ölçüleri / Dimension (mm)				Uç Insert	Vida Screw	Anahtar Torx Key
		Inter Cooland	D	Z	H	d			
MTSBSH XDGT 1550									
TK XDGT 15 001 MTSBSH	✓	X	50	4	40	22	XDGT 1550	M4X11	T15
TK XDGT 15 002 MTSBSH	✓	X	63	5	40	22			

90° XNMM 1607 MTSBSH

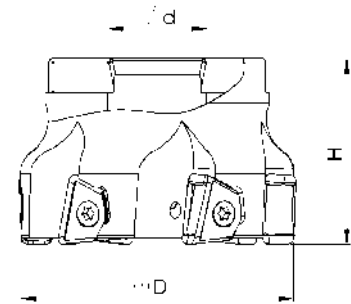

Kesici Uç Uyumluluğu Insert Suitability	Stok / Stock		Takım Ölçüleri / Dimension (mm)				Uç Insert	Vida Screw	Anahtar Torx Key
		Inter Cooland	D	Z	H	d			
MTSBSH XNMM 1607									
TK XNMM 16 001 MTSBSH	✓	✓	50	5	40	22	XNMM 1607	M4X11	T15
TK XNMM 16 002 MTSBSH	✓	✓	63	6	40	22			
TK XNMM 16 003 MTSBSH	✓	✓	80	7	52	27			
TK XNMM 16 004 MTSBSH	✓	✓	100	8	52	32			

90° R390 1806 SNDVK

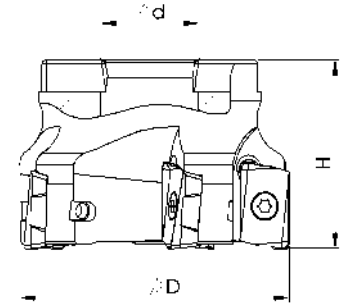

Kesici Uç Uyumluluğu Insert Suitability	Stok / Stock		Takım Ölçüleri / Dimension (mm)				Uç Insert	Vida Screw	Anahtar Torx Key
		Inter Cooland	D	Z	H	d			
SNDVK R390 1806									
TK R390 18 001 SNDVK	✓	X	50	4	40	22	R390 1806	M4X11	T15
TK R390 18 002 SNDVK	✓	X	63	5	40	22			
TK R390 18 003 SNDVK	✓	X	80	6	40	27			
TK R390 18 004 SNDVK	✓	X	100	8	52	32			
TK R390 18 005 SNDVK	✓	X	160	10	52	40			
TK R390 18 006 SNDVK	✓	X	125	9	62	40			
TK R390 18 007 SNDVK	✓	X	200	12	62	60			
TK R390 18 008 SNDVK	✓	X	250	14	62	60			

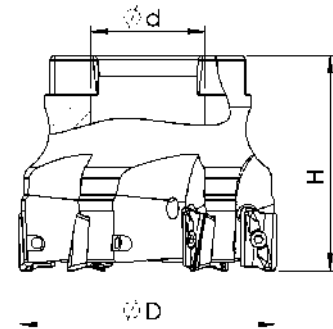

90° R390 11T3 SNDVK



Kesici Uç Uyumluluğu Insert Suitability	Stok / Stock		Takım Ölçüleri / Dimension (mm)				Uç Insert	Vida Screw	Anahtar Torx Key
		Inter Cooland	D	Z	H	d			
SNDVK R390 11T3									
TK R390 11 001 SNDVK	✓	✓	40	5	40	16	R390 11T3	M2,5X7	T8
TK R390 11 002 SNDVK	✓	✓	50	6	40	22			
TK R390 11 003 SNDVK	✓	✓	63	7	50	22			

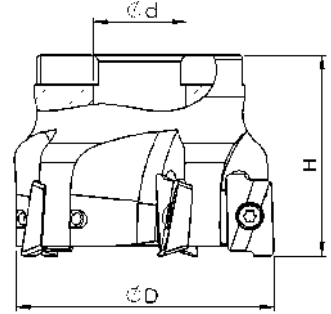

90° ADKT 1704 SNDVK



Kesici Uç Uyumluluğu Insert Suitability	Stok / Stock		Takım Ölçüleri / Dimension (mm)				Uç Insert	Vida Screw	Anahtar Torx Key
		Inter Cooland	D	Z	H	d			
SNDVK R390 ADKT 1704									
TK ADKT 17 001 SNDVK	✓	X	40	4	40	16	ADKT 1704	M3,5X11	T15
TK ADKT 17 002 SNDVK	✓	X	50	4	45	22			
TK ADKT 17 003 SNDVK	✓	X	63	5	45	22			
TK ADKT 17 004 SNDVK	✓	X	80	6	52	27			

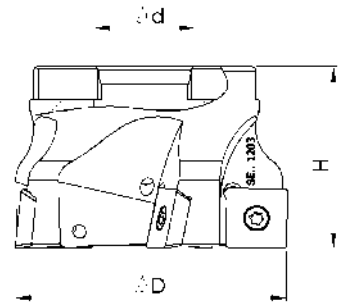





90° SE.. 1203 ZCC/SNDVK

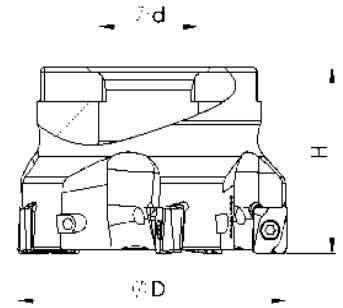

Kesici Uç Uyumluluğu Insert Suitability	Stok / Stock		Takım Ölçüleri / Dimension (mm)				Uç Insert	Vida Screw	Anahtar Torx Key
		Inter Cooland	D	Z	H	d			
ZCC/SNDVK SEET 1203									
TK SEET 12 001 ZCC	✓	✓	50	4	40	22	SEET 1203	M3,5X11	T15
TK SEET 12 002 ZCC	✓	✓	63	5	40	22			
TK SEET 12 003 ZCC	✓	✓	80	6	50	27			
TK SEET 12 004 ZCC	✓	✓	100	7	50	32			
TK SEET 12 005 ZCC	✓	X	125	8	62	40			
TK SEET 12 006 ZCC	✓	X	160	12	62	40			







90° ANGX 1506 ZCC

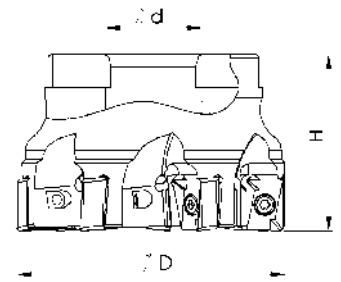

Kesici Uç Uyumluluğu Insert Suitability	Stok / Stock		Takım Ölçüleri / Dimension (mm)				Uç İnsert	Vida Screw	Anahtar Torx Key
		Inter Cooland	D	Z	H	d			
ZCC ANGX 1506									
TK ANGX 15 002 ZCC	✓	✓	40	4	45	16	ANGX 1506	M4X14	T15
TK ANGX 15 003 ZCC	✓	✓	50	4	45	22			
TK ANGX 15 004 ZCC	✓	✓	63	5	45	22			
TK ANGX 15 005 ZCC	✓	✓	80	6	50	27			
TK ANGX 15 006 ZCC	✓	✓	100	8	55	32			
TK ANGX 15 007 ZCC	✓	X	125	9	62	40			
TK ANGX 15 008 ZCC	✓	X	160	10	62	40			
TK ANGX 15 009 ZCC	✓	X	200	14	62	60			

90° ANGX 1105 ZCC



Kesici Uç Uyumluluğu Insert Suitability	Stok / Stock		Takım Ölçüleri / Dimension (mm)				Uç İnsert	Vida Screw	Anahtar Torx Key
		Inter Cooland	D	Z	H	d			
ZCC ANGX 1105									
TK ANGX 11 001 ZCC	✓	✓	50	6	40	22	ANGX 1105	M3X9	T10
TK ANGX 11 002 ZCC	✓	✓	63	7	40	22			
TK ANGX 11 003 ZCC	✓	✓	40	4	40	16			

90° APKT 11T3 ZCC

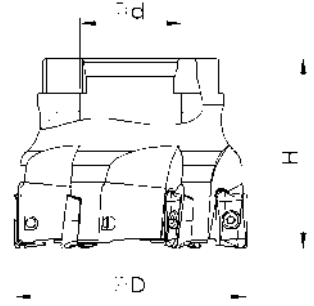

Kesici Uç Uyumluluğu Insert Suitability	Stok / Stock		Takım Ölçüleri / Dimension (mm)				Uç İnsert	Vida Screw	Anahtar Torx Key
		Inter Cooland	D	Z	H	d			
ZCC APKT 11T3									
TK APKT 11 001 ZCC	✓	✓	40	5	45	16	APKT 11T3	M2,5X7	T8
TK APKT 11 002 ZCC	✓	✓	50	6	50	22			
TK APKT 11 003 ZCC	✓	✓	63	7	50	22			

90° APKT 1604 ZCC

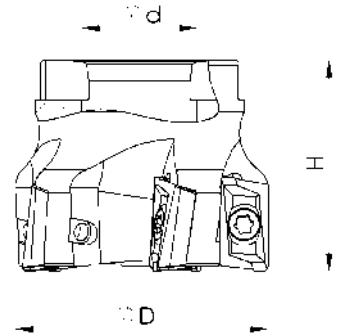

Kesici Uç Uyumluluğu Insert Suitability	Stok / Stock		Takım Ölçüleri / Dimension (mm)				Uç İnsert	Vida Screw	Anahtar Torx Key
		Inter Cooland	D	Z	H	d			
ZCC APKT 1604									
TK AP 16 001 ZCC	✓	X	40	4	40	16	APKT 1604	M4X11	T15
TK AP 16 002 ZCC	✓	X	50	5	40	22			
TK AP 16 003 ZCC	✓	X	63	5	40	22			
TK AP 16 004 ZCC	✓	X	80	7	50	27			
TK AP 16 005 ZCC	✓	X	100	8	50	32			
TK AP 16 006 ZCC	✓	X	125	9	62	40			

90° WNHU 0806 ZCC

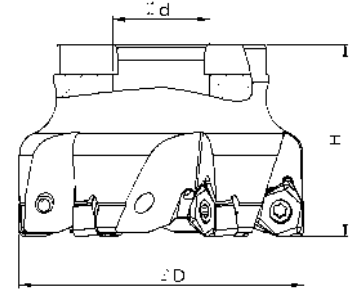

Kesici Uç Uyumluluğu Insert Suitability	Stok / Stock		Takım Ölçüleri / Dimension (mm)				Uç Insert	Vida Screw	Anahtar Torx Key
		Inter Cooland	D	Z	H	d			
ZCC WNHU 0806									
TK WNHU 08 001 ZCC	✓	✓	50	4	40	22	WNHU 0806	M4X11	T15
TK WNHU 08 002 ZCC	✓	✓	63	5	40	22			
TK WNHU 08 003 ZCC	✓	✓	80	6	50	27			
TK WNHU 08 004 ZCC	✓	✓	52	4	40	22			
TK WNHU 08 007 ZCC	✓	X	200	14	62	60			
TK WNHU 08 008 ZCC	✓	X	250	16	62	60			
TK WNHU 08 009 ZCC	✓	✓	63	6	40	22			
TK WNHU 08 010 ZCC	✓	✓	100	8	50	32			
TK WNHU 08 011 ZCC	✓	✓	80	7	50	27			
TK WNHU 08 012 ZCC	✓	✓	80	5	50	27			

90° APKT 10T3 ZCC

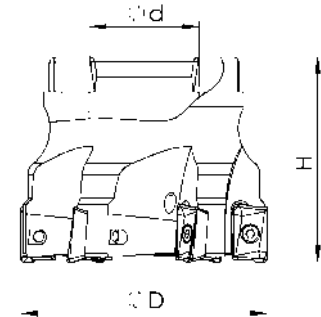

Kesici Uç Uyumluluğu Insert Suitability	Stok / Stock		Takım Ölçüleri / Dimension (mm)				Uç Insert	Vida Screw	Anahtar Torx Key
		Inter Cooland	D	Z	H	d			
ZCC APKT 10T3									
TK APKT 10 001 ZCC	✓	X	40	5	40	16	APKT 10T3	M2,5X7	T8
TK APKT 10 002 ZCC	✓	X	50	6	40	22			
TK APKT 10 003 ZCC	✓	X	63	7	40	22			

90° APLX 1008 ZCC

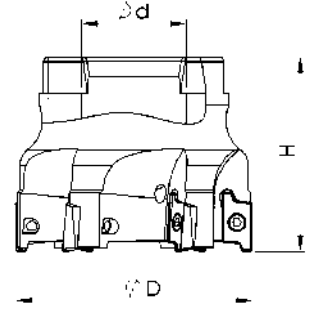

Kesici Uç Uyumluluğu Insert Suitability	Stok / Stock		Takım Ölçüleri / Dimension (mm)				Uç Insert	Vida Screw	Anahtar Torx Key
		Inter Cooland	D	Z	H	d			
ZCC APLX 1008									
TK APLX 10 001 ZCC	✓	✗	40	5	40	16	APLX 1008	M2,5X7	T8
TK APLX 10 002 ZCC	✓	✗	50	6	40	22			
TK APLX 10 003 ZCC	✓	✗	63	7	40	22			



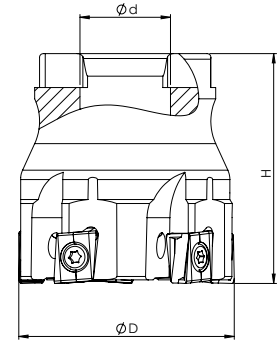



90° LNKT 0804 ZCC

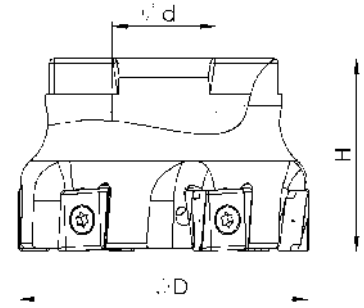

Kesici Uç Uyumluluğu Insert Suitability	Stok / Stock		Takım Ölçüleri / Dimension (mm)				Uç Insert	Vida Screw	Anahtar Torx Key
		Inter Cooland	D	Z	H	d			
ZCC LNKT 0804									
TK LNKT 08 001 ZCC	✓	✗	40	5	40	16	LNKT 0804	M3X10	T10





90° LNKT 1206 ZCC

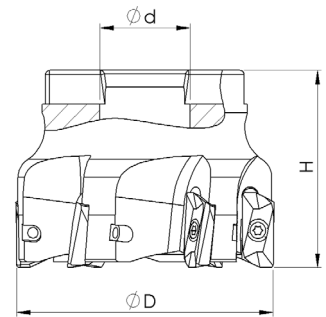

Kesici Uç Uyumluluğu Insert Suitability	Stok / Stock		Takım Ölçüleri / Dimension (mm)				Uç Insert	Vida Screw	Anahtar Torx Key
		Inter Cooland	D	Z	H	d			
ZCC LNKT 1206									
TK LNKT 12 001 ZCC	✓	✓	50	5	40	22	LNKT 1206	M4X11	T15
TK LNKT 12 002 ZCC	✓	✓	63	6	40	22			
TK LNKT 12 003 ZCC	✓	✓	80	7	50	27			
TK LNKT 12 004 ZCC	✓	✓	100	9	50	32			
TK LNKT 12 005 ZCC	✓	X	125	11	62	40			

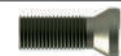

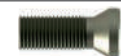
90° EDPT 1404/1805 KNNMTL



Kesici Uç Uyumluluğu Insert Suitability	Stok / Stock		Takım Ölçüleri / Dimension (mm)				Uç Insert	Vida Screw	Anahtar Torx Key
		Inter Cooland	D	Z	H	d			
KNNMTL EDPT 1404/1805									
TK EDPT 14 001 KNM	✓	X	40	4	40	16	EDPT 1404	M3X8	T10
TK EDPT 14 002 KNM	✓	X	50	5	40	22			
TK EDPT 14 004 KNM	✓	X	63	6	50	22			
TK EDPT 14 005 KNM	✓	X	80	7	50	27			
TK EDPT 14 006 KNM	✓	X	100	8	50	32			
TK EDPT 18 007 KNM	✓	X	50	4	40	22	EDPT 1805	M3,5X10	T15
TK EDPT 18 008 KNM	✓	X	63	5	50	22			
TK EDPT 18 009 KNM	✓	X	80	6	50	27			

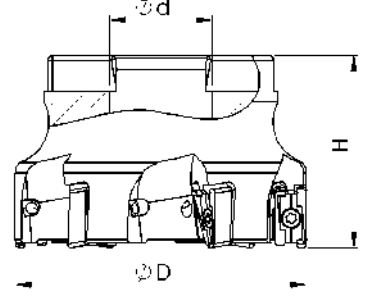

90° LNGU 1104 KNNMTL



Kesici Uç Uyumluluğu Insert Suitability	Stok / Stock		Takım Ölçüleri / Dimension (mm)				Uç İnsert	Vida Screw	Anahtar Torx Key
		Inter Cooland	D	Z	H	d			
KKKMTL LNGU 1104									
TK LNGU 11 001 KNM	✓	✓	40	5	40	16	LNGU 1104	M3X8	T10
TK LNGU 11 002 KNM	✓	✓	50	5	40	22			
TK LNGU 11 003 KNM	✓	✓	63	6	40	22			
TK LNGU 11 004 KNM	✓	✓	80	7	50	27			
TK LNGU 11 005 KNM	✓	✓	50	6	40	22			

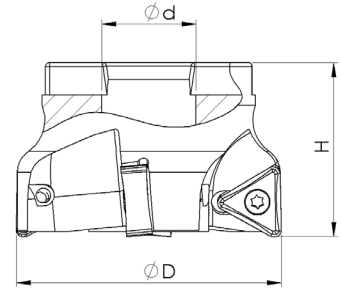

90° TNGX 1905 KNNMTL



Kesici Uç Uyumluluğu Insert Suitability	Stok / Stock		Takım Ölçüleri / Dimension (mm)				Uç İnsert	Vida Screw	Anahtar Torx Key
		Inter Cooland	D	Z	H	d			
KNNMTL TNGX 1905									
TK TNGX 19 001 KNM	✓	✓	63	4	40	22	TNGX 1905	M4X11	T15
TK TNGX 19 002 KNM	✓	✓	63	5	40	22			
TK TNGX 19 003 KNM	✓	✓	80	6	50	27			

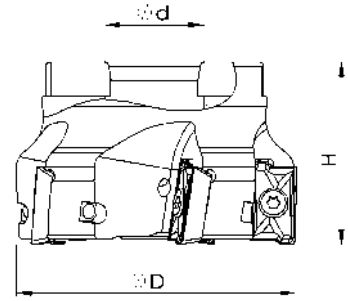

90° BDMT 1704 KYCR

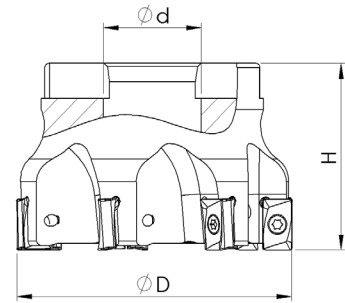

Kesici Uç Uyumluluğu Insert Suitability	Stok / Stock		Takım Ölçüleri / Dimension (mm)				Uç İnsert	Vida Screw	Anahtar Torx Key
		Inter Cooland	D	Z	H	d			
KYCR BDMT 1704									
TK BDMT 17 001 KYCR	✓	✓	40	4	40	16	BDMT 1704	M4X11	T15
TK BDMT 17 002 KYCR	✓	✓	50	5	50	22			
TK BDMT 17 003 KYCR	✓	✓	63	5	50	22			
TK BDMT 17 004 KYCR	✓	✓	80	6	50	27			

90° LOMU 1004 KYCR



Kesici Uç Uyumluluğu Insert Suitability	Stok / Stock		Takım Ölçüleri / Dimension (mm)				Uç İnsert	Vida Screw	Anahtar Torx Key
		Inter Cooland	D	Z	H	d			
KYCR LOMU 1004									
TK LOMU 10 000 KYCR	✓	✓	50	5	45	22	LOMU 1004	M3,5X8	T15
TK LOMU 10 001 KYCR	✓	✓	63	6	50	22			
TK LOMU 10 003 KYCR	✓	✓	80	8	50	27			
TK LOMU 10 004 KYCR	✓	✓	50	6	45	22			
TK LOMU 10 005 KYCR	✓	✓	63	7	50	22			

90° BDMT 11T3 KYCR

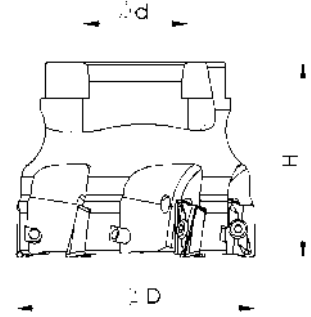

Kesici Uç Uyumluluğu Insert Suitability	Stok / Stock		Takım Ölçüleri / Dimension (mm)				Uç Insert	Vida Screw	Anahtar Torx Key
		Inter Cooland	D	Z	H	d			
KYCR BDMT 11T3									
TK BDMT 11 001 KYCR	✓	✓	40	5	40	16	BDMT 11T3	M2,5X7	T8
TK BDMT 11 002 KYCR	✓	✓	50	6	40	22			

90° WNMU 0504 KYCR NEW

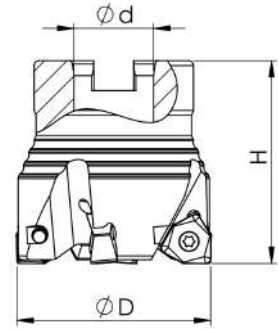

Kesici Uç Uyumluluğu Insert Suitability	Stok / Stock		Takım Ölçüleri / Dimension (mm)				Uç Insert	Vida Screw	Anahtar Torx Key
		Inter Cooland	D	Z	H	d			
KYCR WNMU 0504									
TK WNMU 05 001 KYCR	✓	✓	40	4	40	16	WNMU 0504	M3X8	T10
TK WNMU 05 002 KYCR	✓	✓	50	4	40	22			

90° LOMU 1505 KYCR

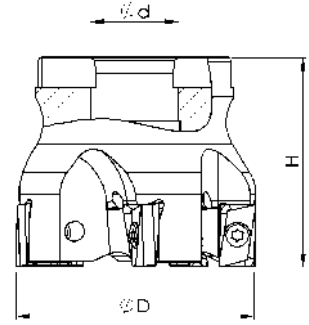

Kesici Uç Uyumluluğu Insert Suitability	Stok / Stock		Takım Ölçüleri / Dimension (mm)				Uç Insert	Vida Screw	Anahtar Torx Key
		Inter Cooland	D	Z	H	d			
KYCR LOMU 1505									
TK LOMU 15 001 KYCR	✓	✓	50	4	40	22	LOMU 1505	M4X11	T15
TK LOMU 15 002 KYCR	✓	✓	63	5	40	22			
TK LOMU 15 003 KYCR	✓	✓	80	6	52	27			
TK LOMU 15 006 KYCR	✓	X	160	12	62	40			
TK LOMU 15 008 KYCR	✓	X	200	14	62	60			

90° WNMU 0806 KYCR

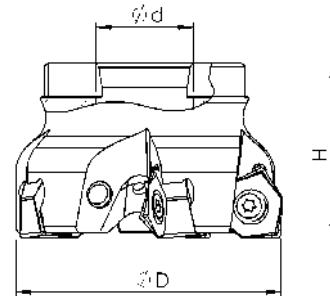

Kesici Uç Uyumluluğu Insert Suitability	Stok / Stock		Takım Ölçüleri / Dimension (mm)				Uç Insert	Vida Screw	Anahtar Torx Key
		Inter Cooland	D	Z	H	d			
KYCR WNMU 0806									
TK WNMU 08 001 KYCR	✓	✓	50	4	40	22	WNMU 0806	M5X12	T20
TK WNMU 08 002 KYCR	✓	✓	52	4	40	22			
TK WNMU 08 003 KYCR	✓	✓	63	4	40	22			
TK WNMU 08 004 KYCR	✓	✓	63	5	40	22			
TK WNMU 08 005 KYCR	✓	✓	80	5	45	27			
TK WNMU 08 006 KYCR	✓	✓	80	6	45	27			
TK WNMU 08 007 KYCR	✓	✓	100	7	50	32			
TK WNMU 08 008 KYCR	✓	X	125	8	50	40			
TK WNMU 08 009 KYCR	✓	X	160	10	62	40			
TK WNMU 08 010 KYCR	✓	✓	63	6	52	22			
TK WNMU 08 011 KYCR	✓	X	200	12	62	60			
TK WNMU 08 012 KYCR	✓	X	250	14	62	60			

90° LQMU 1107 TNGLY

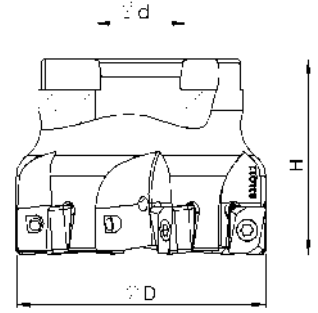

Kesici Uç Uyumluluğu Insert Suitability	Stok / Stock		Takım Ölçüleri / Dimension (mm)				Uç İnsert	Vida Screw	Anahtar Torx Key
		Inter Cooland	D	Z	H	d			
TNGLY LQMU 1107									
TK LQMU 11 001 TNG	✓	✓	50	5	40	22	LQMU 1107	M3,5X8	T15
TK LQMU 11 002 TNG	✓	✓	63	6	45	22			
TK LQMU 11 003 TNG	✓	✓	80	8	52	27			

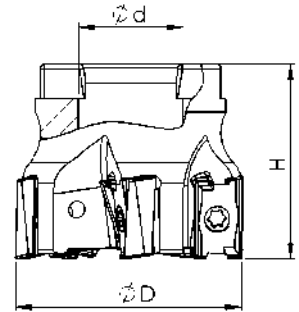

90° XNGU 15T6 WDA



Kesici Uç Uyumluluğu Insert Suitability	Stok / Stock		Takım Ölçüleri / Dimension (mm)				Uç İnsert	Vida Screw	Anahtar Torx Key
		Inter Cooland	D	Z	H	d			
WDA XNGU 15T6									
TK XNGU 15 001 WDA	✓	✓	40	4	40	16	XNGU 15T6	M4X14	T15
TK XNGU 15 002 WDA	✓	✓	50	5	40	22			
TK XNGU 15 003 WDA	✓	✓	63	5	40	22			
TK XNGU 15 004 WDA	✓	✓	80	6	50	27			
TK XNGU 15 005 WDA	✓	✓	50	4	40	22			

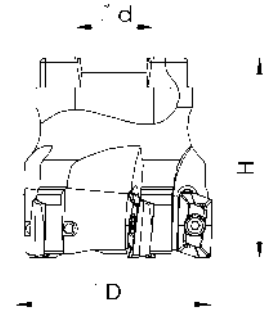

90° XDPT 1104/1704 WDA



Kesici Uç Uyumluluğu Insert Suitability	Stok / Stock		Takım Ölçüleri / Dimension (mm)				Uç İnsert	Vida Screw	Anahtar Torx Key
		Inter Cooland	D	Z	H	d			
WDA XDPT 1104/1704									
TK XDPT 11 001 WDA	✓	✓	40	5	40	16	XDPT 1104	M2,5X7	T8
TK XDPT 11 002 WDA	✓	✓	50	6	40	22			
TK XDPT 17 001 WDA	✓	✓	50	5	40	22	XDPT 1704	M4X11	T15
TK XDPT 17 002 WDA	✓	✓	63	6	40	22			

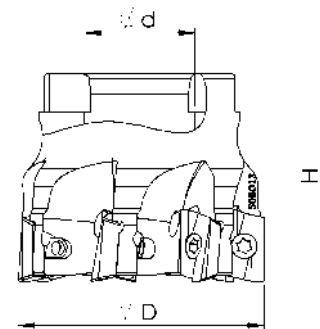

90° BOMT 1304 INGRSL



Kesici Uç Uyumluluğu Insert Suitability	Stok / Stock		Takım Ölçüleri / Dimension (mm)				Uç İnsert	Vida Screw	Anahtar Torx Key
		Inter Cooland	D	Z	H	d			
INGRSL BOMT 1304									
TK BOMT 13 001 INGRSL	✓	✓	50	7	40	22	BOMT 1304	M3,5X8	T15
TK BOMT 13 002 INGRSL	✓	✓	63	5	40	22			
TK BOMT 13 003 INGRSL	✓	✓	63	8	40	22			
TK BOMT 13 004 INGRSL	✓	✓	80	10	50	27			

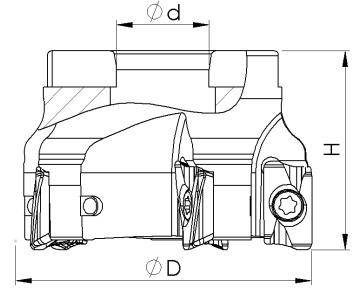

90° AOMT 1605 INGRSL



Kesici Uç Uyumluluğu Insert Suitability	Stok / Stock		Takım Ölçüleri / Dimension (mm)				Uç Insert	Vida Screw	Anahtar Torx Key
		Inter Cooland	D	Z	H	d			
INGRSL AOMT 1605									
TK AOMT 16 001 INGRSL	✓	X	50	4	40	22	AOMT 1605	M4X11	T15
TK AOMT 16 002 INGRSL	✓	X	63	5	40	22			
TK AOMT 16 003 INGRSL	✓	X	80	6	50	27			
TK AOMT 16 004 INGRSL	✓	X	100	8	50	32			

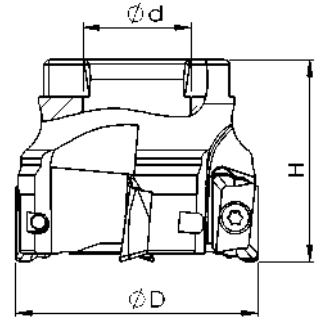

90° XDKT 1505 CRTZT



Kesici Uç Uyumluluğu Insert Suitability	Stok / Stock		Takım Ölçüleri / Dimension (mm)				Uç Insert	Vida Screw	Anahtar Torx Key
		Inter Cooland	D	Z	H	d			
CRTZT XDKT 1505									
TK XDKT 15 001 CRTZT	✓	X	50	4	40	22	XDKT 1505	M4X11	T15
TK XDKT 15 002 CRTZT	✓	X	63	5	40	22			

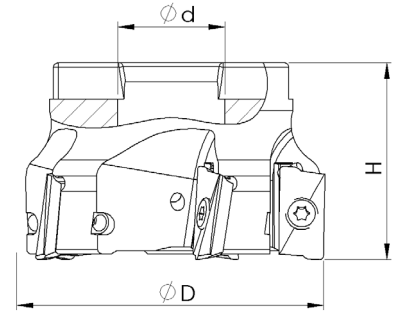

90° AP..1805 DJT

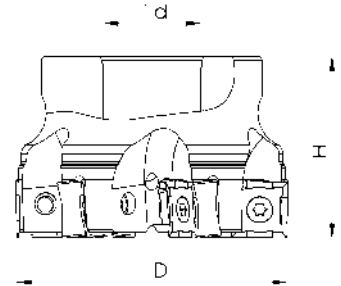

Kesici Uç Uyumluluğu Insert Suitability	Stok / Stock		Takım Ölçüleri / Dimension (mm)				Uç Insert	Vida Screw	Anahtar Torx Key
		Inter Cooland	D	Z	H	d			
DJT AP..1805									
TK AP..18 001 DJT	✓	X	63	5	40	22	AP..1805	M4X11	T15
TK AP..18 002 DJT	✓	X	100	8	52	32			
TK AP..18 003 DJT	✓	X	125	9	62	40			

88° SNMX 1206 KRLY



Kesici Uç Uyumluluğu Insert Suitability	Stok / Stock		Takım Ölçüleri / Dimension (mm)				Uç Insert	Vida Screw	Anahtar Torx Key
		Inter Cooland	D	Z	H	d			
KRLY SNMX 1206									
TK SNMX 12 001 KRLY	✓	✓	50	5	40	22	SNMX 1206	M4,5X11	T20
TK SNMX 12 002 KRLY	✓	✓	63	6	40	22			
TK SNMX 12 003 KRLY	✓	✓	80	8	50	27			
TK SNMX 12 004 KRLY	✓	✓	100	10	50	32			
TK SNMX 12 005 KRLY	✓	X	125	11	62	40			
TK SNMX 12 006 KRLY	✓	X	160	12	62	40			
TK SNMX 12 007 KRLY	✓	X	160	14	62	40			
TK SNMX 12 008 KRLY	✓	X	250	18	62	60			
TK SNMX 12 009 KRLY	✓	X	200	14	62	60			

88° SNMU 1305 KYCR

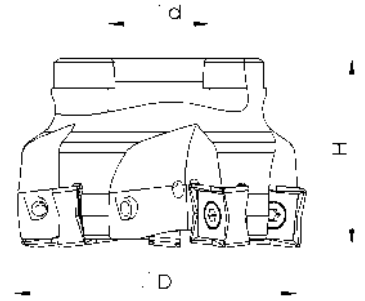

Kesici Uç Uyumluluğu Insert Suitability	Stok / Stock		Takım Ölçüleri / Dimension (mm)				Uç İnsert	Vida Screw	Anahtar Torx Key
		Inter Cooland	D	Z	H	d			
KYCR SNMU 1305									
TK SNMU 13 001 KYCR	✓	✓	50	4	40	22	SNMU 1305	M4X11	T15
TK SNMU 13 002 KYCR	✓	✓	63	5	40	22			

88° SNCU 1205 ZCC

NEW

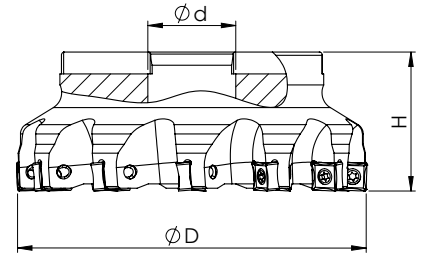

Kesici Uç Uyumluluğu Insert Suitability	Stok / Stock		Takım Ölçüleri / Dimension (mm)				Uç İnsert	Vida Screw	Anahtar Torx Key
		Inter Cooland	D	Z	H	d			
ZCC SNCU 1205									
TK SNCU 12 001 ZCC	✓	X	160	12	62	40	SNCU 1205	M5X12	T20

75° APKT 1003/1604 ISO

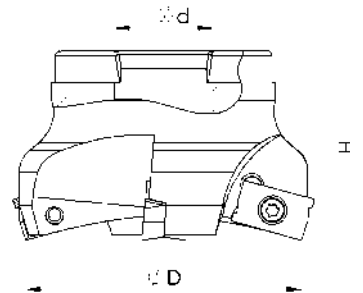

Kesici Uç Uyumluluğu Insert Suitability	Stok / Stock		Takım Ölçüleri / Dimension (mm)				Uç İnsert	Vida Screw	Anahtar Torx Key
		Inter Cooland	D	Z	H	d			
ISO APKT 1003/1604									
TK EM 75 AP 10 007 ISO	✓	X	63	6	40	22	AP..1003	M2,5X7	T08
TK EM 75 AP 16 001 ISO	✓	X	63	4	40	22			
TK EM 75 AP 16 002 ISO	✓	X	80	5	40	27			
TK EM 75 AP 16 003 ISO	✓	X	100	6	40	32	APKT 1604	M3,5X11	T15
TK EM 75 AP 16 004 ISO	✓	X	125	7	52	40			
TK EM 75 AP 16 005 ISO	✓	X	160	8	52	40			

Lütfen Sipariş vermeden önce stok durumunu sorunuz.
Please ask before ordering, stock status.

L: Sol / Left

R: Sağ / Right

✓ Stokta / In Stock

X Stokta Yok / Non Stock

75° SPKN 1203/1504 ISO

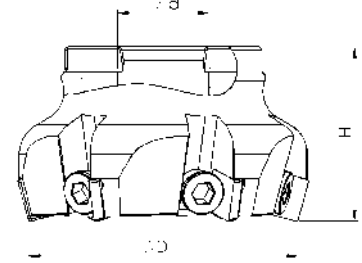

Kesici Uç Uyumluluğu Insert Suitability	Stok / Stock		Takım Ölçüleri / Dimension (mm)				Uç Insert	Vida Screw	Anahtar Allen Key
		Inter Cooland	D	Z	H	d			
ISO SPKN 1203									
TK SPKN 12 001 ISO	✓	X	63	5	40	22	SPKN 1203	M8X1,25 (L)	A6
TK SPKN 12 002 ISO	✓	X	80	6	50	27			
TK SPKN 12 003 ISO	✓	X	100	8	50	32			
TK SPKN 12 004 ISO	✓	X	125	10	62	40			
TK SPKN 12 005 ISO	✓	X	160	12	62	40			
TK SPKN 12 006 ISO	✓	X	200	12	62	60			
TK SPKN 15 001 ISO	✓	X	125	10	62	40	SPKN 1504		

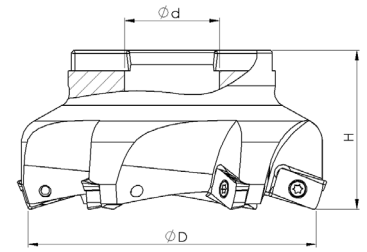

75° R390 1806 SNDVK



Kesici Uç Uyumluluğu Insert Suitability	Stok / Stock		Takım Ölçüleri / Dimension (mm)				Uç Insert	Vida Screw	Anahtar Torx Key
		Inter Cooland	D	Z	H	d			
SNDVK R390 1806									
TK 75 R390 18 000 SNDVK	✓	X	80	4	52	27	R390 1806	M4X11	T15
TK 75 R390 18 001 SNDVK	✓	X	100	5	52	32			
TK 75 R390 18 002 SNDVK	✓	X	125	6	62	40			
TK 75 R390 18 003 SNDVK	✓	X	160	7	62	40			

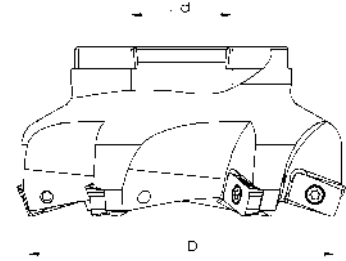

75° R390 1704 SNDVK



Kesici Uç Uyumluluğu Insert Suitability	Stok / Stock		Takım Ölçüleri / Dimension (mm)				Uç İnsert	Vida Screw	Anahtar Torx Key
		Inter Cooland	D	Z	H	d			
SNDVK R390 1704									
TK 75 ADKT 17 004 SNDVK	✓	✗	63	4	42	22	R390 1704	M3,5X11	T15
TK 75 ADKT 17 005 SNDVK	✓	✗	80	5	52	27			
TK 75 ADKT 17 006 SNDVK	✓	✗	100	6	52	32			

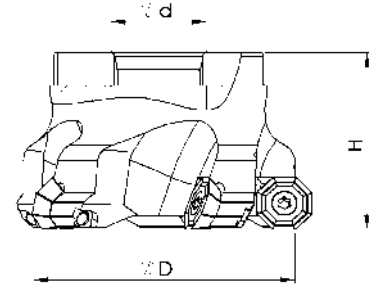

45° OFKT 05T3 ZCC

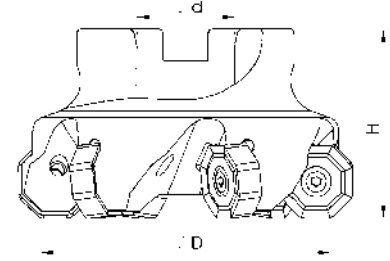

Kesici Uç Uyumluluğu Insert Suitability	Stok / Stock		Takım Ölçüleri / Dimension (mm)				Uç İnsert	Vida Screw	Anahtar Torx Key
		Inter Cooland	D	Z	H	d			
ZCC OFKT 05T3									
TK OFKT 05 001 ZCC	✓	✓	50	4	40	22	OFKT 05T3	M4X11	T15
TK OFKT 05 002 ZCC	✓	✓	63	5	40	22			
TK OFKT 05 003 ZCC	✓	✓	80	6	50	27			
TK OFKT 05 004 ZCC	✓	✓	100	7	50	32			

45° ONHU 08T6 ZCC



Kesici Uç Uyumluluğu Insert Suitability	Stok / Stock		Takım Ölçüleri / Dimension (mm)				Uç İnsert	Vida Screw	Anahtar Torx Key
		Inter Cooland	D	Z	H	d			
ZCC ONHU 08T6									
TK ONHU 08T 000 ZCC	✓	✓	50	4	50	22	ONHU 08T6	M4,5X15	T20
TK ONHU 08T 001 ZCC	✓	✓	63	5	50	22			
TK ONHU 08T 002 ZCC	✓	✓	80	6	50	27			
TK ONHU 08T 003 ZCC	✓	✓	100	7	50	32			
TK ONHU 08T 004 ZCC	✓	✗	125	8	62	40			
TK ONHU 08T 005 ZCC	✓	✗	160	10	62	40			

Lütfen Sipariş vermeden önce stok durumunu sorunuz.
Please ask before ordering, stock status.

L: Sol / Left

R: Sağ / Right

✓ Stokta / In Stock

✗ Stokta Yok / Non Stock

45° ONHU 060408 ZCC

NEW

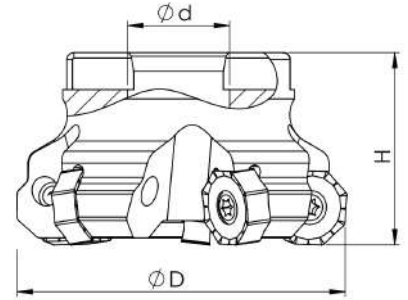

Kesici Uç Uyumluluğu Insert Suitability	Stok / Stock		Takım Ölçüleri / Dimension (mm)				Uç Insert	Vida Screw	Anahtar Torx Key
		Inter Cooland	D	Z	H	d			
ZCC ONHU 0604									
TK ONHU 06 001 ZCC	✓	X	50	4	40	22	ONHU 0604	M5X12	T20
TK ONHU 06 002 ZCC	✓	X	63	5	40	22			
TK ONHU 06 003 ZCC	✓	X	80	7	50	27			
TK ONHU 06 004 ZCC	✓	X	100	8	52	32			
TK ONHU 06 005 ZCC	✓	X	125	9	62	40			

45° ONHU 0806 ZCC

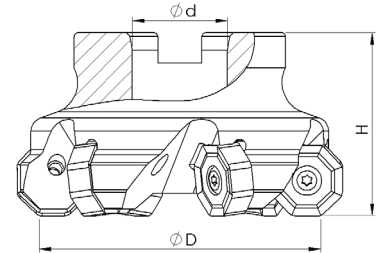

Kesici Uç Uyumluluğu Insert Suitability	Stok / Stock		Takım Ölçüleri / Dimension (mm)				Uç Insert	Vida Screw	Anahtar Torx Key
		Inter Cooland	D	Z	H	d			
ZCC ONHU 0806									
TK ONHU 08 001 ZCC	✓	✓	63	5	40	22	ONHU 0806	M4X12	T15
TK ONHU 08 002 ZCC	✓	✓	80	6	50	27			
TK ONHU 08 003 ZCC	✓	✓	100	7	50	32			
TK ONHU 08 004 ZCC	✓	X	125	8	62	40			
TK ONHU 08 005 ZCC	✓	X	160	10	62	40			

45° SNEG 1205 ZCC

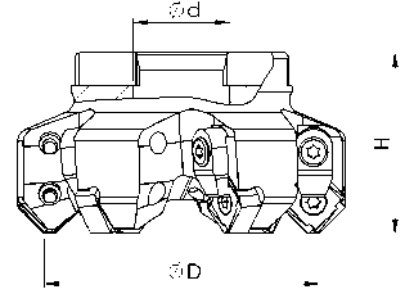

Kesici Uç Uyumluluğu Insert Suitability	Stok / Stock		Takım Ölçüleri / Dimension (mm)				Uç Insert	Pabuç Clamp	Vida Screw	Anahtar Torx Key
		Inter Cooland	D	Z	H	d				
ZCC SNEG 1205										
TK SNEG 12 001 ZCC	✓	✓	63	6	40	22	SNEG 1205	CK 15	M4X11	T15
TK SNEG 12 002 ZCC	✓	✓	80	7	50	27				
TK SNEG 12 003 ZCC	✓	✓	125	10	62	40				
TK SNEG 12 004 ZCC	✓	✓	160	12	62	40				
TK SNEG 12 005 ZCC	✓	✓	50	5	40	22				
TK SNEG 12 006 ZCC	✓	✓	100	8	62	32				
TK SNEG 12 007 ZCC	✓	✗	250	14	62	60				

45° SE..12T3/SE 15..ZCC/SNDVK

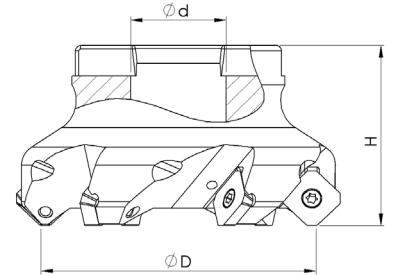

Kesici Uç Uyumluluğu Insert Suitability	Stok / Stock		Takım Ölçüleri / Dimension (mm)				Uç Insert	Vida Screw	Anahtar Torx Key
		Inter Cooland	D	Z	H	d			
ZCC - SNDVK SEET 12T3 SE 15..									
TK SE.. 12 001 ZCC	✓	✓	50	4	40	22	SE..12T3	M3,5X11	T15
TK SE.. 12 002 ZCC	✓	✓	63	5	40	22			
TK SE.. 12 003 ZCC	✓	✓	80	6	50	27			
TK SE.. 12 004 ZCC	✓	✓	100	7	50	32			
TK SE.. 12 005 ZCC	✓	✗	125	8	62	40			
TK SE.. 12 006 ZCC	✓	✗	125	9	62	40			
TK SE.. 12 007 ZCC	✓	✗	160	10	62	40			
TK SEET 15 008 ZCC	✓	✓	100	7	50	32	SEET 15	M4,5X15	T20
TK SEET 15 009 ZCC	✓	✗	125	8	62	40			
TK SEET 15 010 ZCC	✓	✗	160	10	62	40			

45° ODKT/ODHT 0605

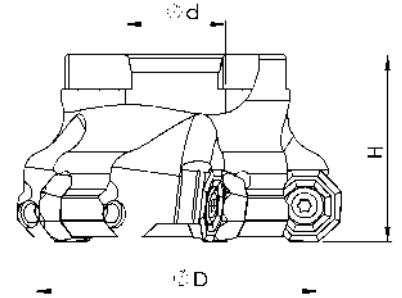

Kesici Uç Uyumluluğu Insert Suitability	Stok / Stock		Takım Ölçüleri / Dimension (mm)				Uç Insert	Vida Screw	Anahtar Torx Key
		Inter Cooland	D	Z	H	d			
ZCC ODKT/ODHT 0605									
TK ODKT 06 001 ZCC	✓	✓	50	4	40	22	ODKT 0605	M5X12	T20
TK ODKT 06 002 ZCC	✓	✓	63	5	40	22			
TK ODKT 06 003 ZCC	✓	✓	80	6	50	27			
TK ODKT 06 004 ZCC	✓	✓	100	7	50	32			
TK ODKT 06 005 ZCC	✓	X	125	8	52	40			
TK ODKT 06 006 ZCC	✓	X	200	12	62	60			

45° SEEX 1204 SCO

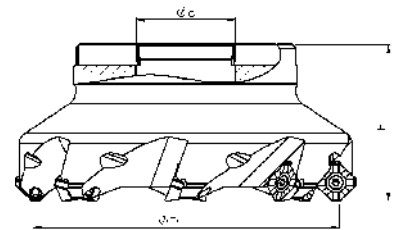

Kesici Uç Uyumluluğu Insert Suitability	Stok / Stock		Takım Ölçüleri / Dimension (mm)				Uç Insert	Vida Screw	Anahtar Torx Key
		Inter Cooland	D	Z	H	d			
SCO SEEX 1204									
TK SEEX 12 001 SCO	✓	X	125	8	62	40	SEEX 1204	M4X11	T15
TK SEEX 12 002 SCO	✓	X	160	10	62	40			

45° OFMT 0706 ISO

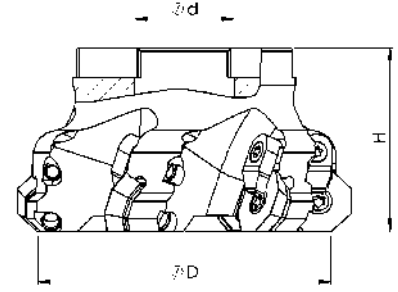

Kesici Uç Uyumluluğu Insert Suitability	Stok / Stock		Takım Ölçüleri / Dimension (mm)				Uç İnsert	Vida Screw	Pabuç Clamp	Vida Screw	Anahtar Torx Key
		Inter Cooland	D	Z	H	d					
ISO OFMT 0706											
TK OFMT 07 001 ISO	✓	✓	63	5	43	22	OFMT 0706	M5X12	CK15	M4X11	T20
TK OFMT 07 002 ISO	✓	✓	80	6	50	27					
TK OFMT 07 003 ISO	✓	✓	100	7	50	32					
TK OFMT 07 004 ISO	✓	X	125	8	62	40					
TK OFMT 07 005 ISO	✓	X	160	12	62	40					
TK OFPT 07 001 ISO	✓	X	160	12	62	40	OFMT 0706				

45° ONGX 0606 ISO

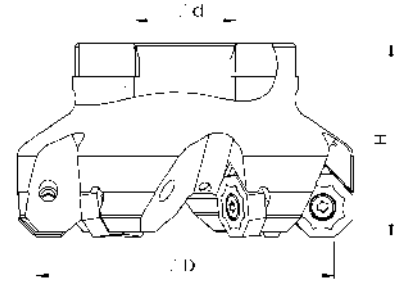

Kesici Uç Uyumluluğu Insert Suitability	Stok / Stock		Takım Ölçüleri / Dimension (mm)				Uç İnsert	Vida Screw	Anahtar Torx Key
		Inter Cooland	D	Z	H	d			
ISO ONGX 0606									
TK ONGX 06 001 ISO	✓	✓	63	5	45	22	ONGX 0606	M4,5X17	T20
TK ONGX 06 002 ISO	✓	✓	80	6	50	27			
TK ONGX 06 003 ISO	✓	✓	100	8	50	32			
TK ONGX 06 004 ISO	✓	X	125	9	62	40			
TK ONGX 06 005 ISO	✓	X	160	10	62	40			

45° ONMU 0504 ISO

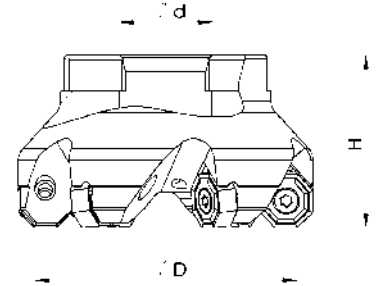

Kesici Uç Uyumluluğu Insert Suitability	Stok / Stock		Takım Ölçüleri / Dimension (mm)				Uç Insert	Vida Screw	Anahtar Torx Key
		Inter Cooland	D	Z	H	d			
ISO ONMU 0504									
TK ONMU 05 001 ISO	✓	✓	50	5	40	22	ONMU 0504	M4X11	T15
TK ONMU 05 002 ISO	✓	✓	63	6	40	22			
TK ONMU 05 003 ISO	✓	✓	80	7	50	27			
TK ONMU 05 004 ISO	✓	✓	100	8	52	32			
TK ONMU 05 005 ISO	✓	X	125	9	62	40			
TK ONMU 05 006 ISO	✓	X	160	10	62	40			

45° PNCU 0805 ISO

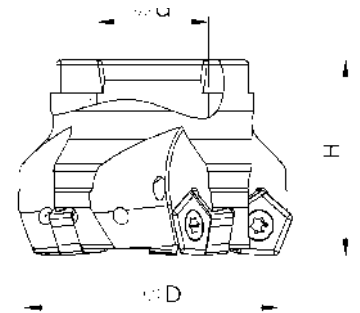

Kesici Uç Uyumluluğu Insert Suitability	Stok / Stock		Takım Ölçüleri / Dimension (mm)				Uç Insert	Vida Screw	Anahtar Torx Key
		Inter Cooland	D	Z	H	d			
INGRSL PNCU 0805									
TK PNCU 08 001 INGRSL	✓	✓	40	4	40	16	PNCU 0805	M4X11	T15
TK PNCU 08 003 INGRSL	✓	✓	50	5	40	22			
TK PNCU 08 004 INGRSL	✓	✓	80	6	50	27			
TK PNCU 08 005 INGRSL	✓	✓	63	5	50	22			

45° SEKR 1204 ISO

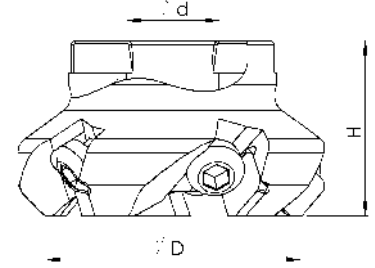

Kesici Uç Uyumluluğu
Insert Suitability

ISO
SEKR 1204

TK SEKR 12 001 ISO
TK SEKR 12 002 ISO

Stok / Stock

Inter Cooland

Takım Ölçüleri / Dimension (mm)

D

Z

H

d

Uç
İnsert

Vida
Screw

Anahtar
Allen Key



SEKR 1204

M8X22 SOL

A6

45° SN.. 1206 KRLY

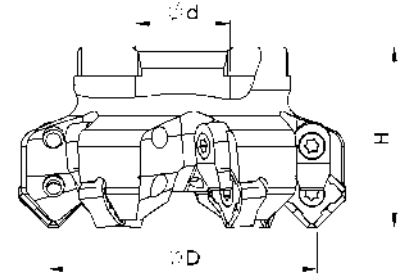

Kesici Uç Uyumluluğu
Insert Suitability

KRLY
SN..1206

TK SN.. 12 001 KRLY
TK SN.. 12 002 KRLY
TK SN.. 12 003 KRLY
TK SN.. 12 004 KRLY
TK SN.. 12 005 KRLY
TK SN.. 12 006 KRLY

Stok / Stock

Inter Cooland

Takım Ölçüleri / Dimension (mm)

D

Z

H

d

Uç
İnsert

Vida
Screw

Pabuç
Clamp

Vida
Screw

Anahtar
Torx Key



SN.. 1206

M4X12

CK15

M4X12

T15

45° SNMX 1407 SECO

NEW

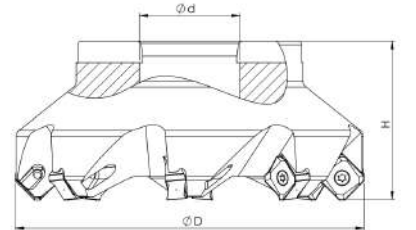

Kesici Uç Uyumluluğu
Insert Suitability

SECO
SNMX 1407

TK SNMX 14 001 SCO
TK SNMX 14 002 SCO

Stok / Stock

Inter Cooland

Takım Ölçüleri / Dimension (mm)

D

Z

H

d

Uç
İnsert

Vida
Screw

Anahtar
Allen Key



SNGU 1408

M4,5X11

T20

45° SNHG 1205 VNDRT

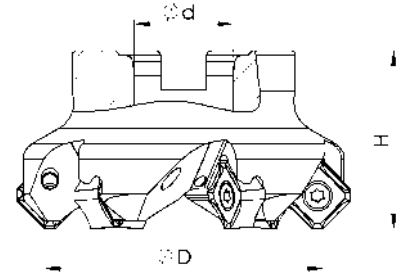

Kesici Uç Uyumluluğu Insert Suitability	Stok / Stock		Takım Ölçüleri / Dimension (mm)				Uç Insert	Vida Screw	Anahtar Torx Key
		Inter Cooland	D	Z	H	d			
VNDRT SNHG 1205									
TK SNHG 12 001 VNDRT	✓	✓	50	6	40	22	SNHG 1205	M4X11	T15
TK SNHG 12 002 VNDRT	✓	✓	63	6	40	22			
TK SNHG 12 003 VNDRT	✓	✓	80	7	50	27			
TK SNHG 12 004 VNDRT	✓	✓	100	8	50	32			

45° SNGU 1408 MTSBSH NEW

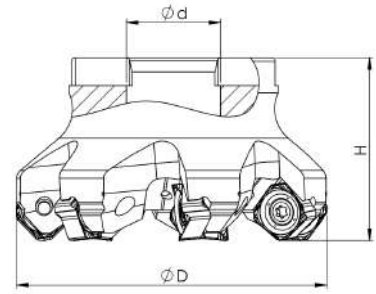

Kesici Uç Uyumluluğu Insert Suitability	Stok / Stock		Takım Ölçüleri / Dimension (mm)				Uç Insert	Vida Screw	Anahtar Torx Key
		Inter Cooland	D	Z	H	d			
MTSBSH SNGU 1408									
TK SNGU 14 001 MTSBSH	✓	✓	63	5	40	22	SNGU 1408	M4,5X11	T20
TK SNGU 14 002 MTSBSH	✓	✓	80	7	50	27			
TK SNGU 14 003 MTSBSH	✓	✓	100	9	50	32			

88° SNMX 1306 TT

NEW

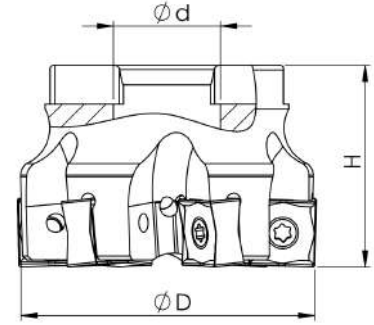

Kesici Uç Uyumluluğu Insert Suitability	Stok / Stock		Takım Ölçüleri / Dimension (mm)				Uç Insert	Vida Screw	Anahtar Torx Key
		Inter Cooland	D	Z	H	d			
TT SNMX 1306									
TK SNMX 13 001 TT	X	✓	63	6	40	22	SNMX 1306	M4,5X11	T20
TK SNMX 13 002 TT	X	✓	80	8	50	27			
TK SNMX 13 003 TT	X	✓	100	10	50	32			



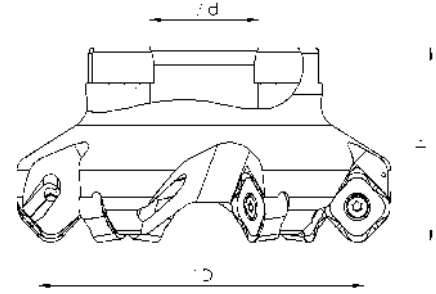



45° SNMX 1607 TT

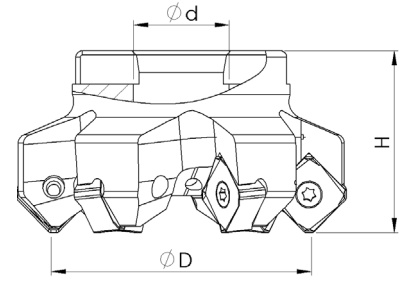

Kesici Uç Uyumluluğu Insert Suitability	Stok / Stock		Takım Ölçüleri / Dimension (mm)				Uç Insert	Vida Screw	Anahtar Torx Key
		Inter Cooland	D	Z	H	d			
TT SNMX 1607									
TK SNMX 16 001 TT	✓	✓	100	6	52	32	SNMX 1607	M4,5X12	T20
TK SNMX 16 002 TT	✓	X	125	8	62	40			
TK SNMX 16 003 TT	✓	X	160	10	62	40			







45° SNMU 13T6 SMTM

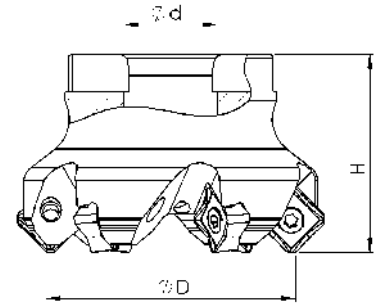

Kesici Uç Uyumluluğu Insert Suitability	Stok / Stock		Takım Ölçüleri / Dimension (mm)				Uç Insert	Vida Screw	Anahtar Torx Key
		Inter Cooland	D	Z	H	d			
SMTM SNMU 13T6									
TK SNMU 13T 001 SMTM	✓	✓	63	6	40	22	SNMU 13T6	M4X11	T15
TK SNMU 13T 002 SMTM	✓	✓	80	7	50	27			
TK SNMU 13T 003 SMTM	✓	✓	100	8	50	32			

45° SN.. 1305 I



Kesici Uç Uyumluluğu Insert Suitability	Stok / Stock		Takım Ölçüleri / Dimension (mm)				Uç Insert	Vida Screw	Anahtar Torx Key
		Inter Cooland	D	Z	H	d			
I SN..1305									
TK SN..13 001 I	✓	✓	50	4	40	22	SN.. 1305	M4,5X12	T20
TK SN..13 002 I	✓	✓	63	6	40	22			
TK SN..13 003 I	✓	✓	80	7	50	27			
TK SN..13 004 I	✓	✓	100	8	50	32			
TK SN..13 005 I	✓	X	125	9	62	40			



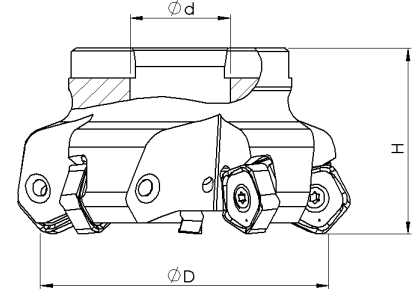



45° PNMU 0905/1205 KYCR

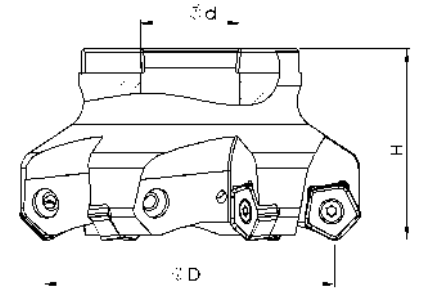

Kesici Uç Uyumluluğu Insert Suitability	Stok / Stock		Takım Ölçüleri / Dimension (mm)				Uç Insert	Vida Screw	Anahtar Torx Key
		Inter Cooland	D	Z	H	d			
KYCR PNMU 0905/1205									
TK PNMU 12 002 KYCR	✓	✓	50	4	40	22	PNMU 1205	M5X12	T20
TK PNMU 12 003 KYCR	✓	✓	63	5	40	22			
TK PNMU 12 004 KYCR	✓	✓	80	5	45	27			
TK PNMU 12 005 KYCR	✓	✓	100	8	50	32			
TK PNMU 12 006 KYCR	✓	✗	125	10	50	40			
TK PNMU 12 007 KYCR	✓	✗	160	12	50	40			
TK PNMU 12 008 KYCR	✓	✗	200	12	62	60			
TK PNMU 12 009 KYCR	✓	✗	250	14	62	60			

45° PNMU 0905 SNG



Kesici Uç Uyumluluğu Insert Suitability	Stok / Stock		Takım Ölçüleri / Dimension (mm)				Uç Insert	Vida Screw	Anahtar Torx Key
		Inter Cooland	D	Z	H	d			
SNG PNMU 0905									
TK PNMU 09 001 SNG	✓	✓	50	4	40	22	PNMU 0905	M4X11	T15
TK PNMU 09 003 SNG	✓	✓	80	6	50	27			
TK PNMU 09 004 SNG	✓	✓	100	7	52	32			
TK PNMU 09 005 SNG	✓	✗	125	10	62	40			

45° HN..0604 KNNMTL

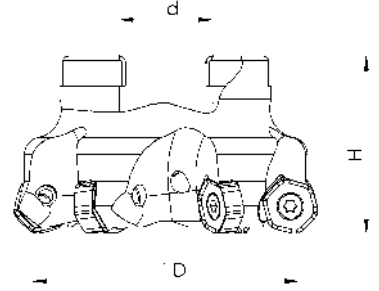

Kesici Uç Uyumluluğu Insert Suitability	Stok / Stock		Takım Ölçüleri / Dimension (mm)				Uç Insert	Vida Screw	Anahtar Torx Key
		Inter Cooland	D	Z	H	d			
KNNMTL HN.. 0604									
TK HN.. 06 001 KNM	✓	✓	50	4	40	22	HN.. 0604	M4X11	T15
TK HN.. 06 002 KNM	✓	✓	63	6	40	22			
TK HN.. 06 003 KNM	✓	✓	80	6	50	27			
TK HN.. 06 004 KNM	✓	✓	100	8	50	32			
TK HN.. 06 005 KNM	✓	✗	125	10	62	40			

45° HNGJ 0905 WDA/KNNMTL

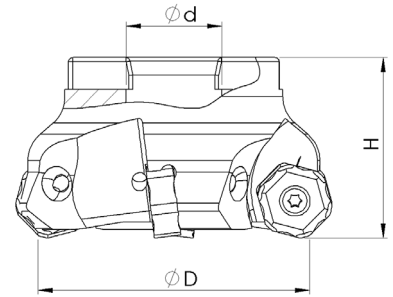

Kesici Uç Uyumluluğu Insert Suitability	Stok / Stock		Takım Ölçüleri / Dimension (mm)				Uç Insert	Vida Screw	Anahtar Torx Key
		Inter Cooland	D	Z	H	d			
WDA-KNNMTL HNGJ 0905									
TK HN.. 09 001 KN WD	✓	✓	50	4	40	22	HNGJ 0905	M4X14	T15
TK HN.. 09 002 KN WD	✓	✓	63	4	40	22			
TK HN.. 09 004 KN WD	✓	✓	80	6	50	27			
TK HN.. 09 005 KN WD	✓	✓	100	8	52	32			
TK HN.. 09 006 KN WD	✓	✗	125	10	62	40			
TK HN.. 09 007 KN WD	✓	✗	160	12	62	40			
TK HN.. 09 008 KN WD	✓	✗	200	10	62	60			
TK HN.. 09 010 KNM WD	✓	✗	250	14	62	60			

45° HNPJ 0704 WDA

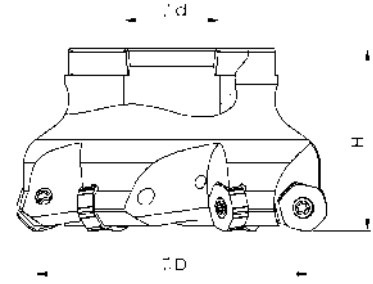

Kesici Uç Uyumluluğu Insert Suitability	Stok / Stock		Takım Ölçüleri / Dimension (mm)				Uç Insert	Vida Screw	Anahtar Torx Key
		Inter Cooland	D	Z	H	d			
WDA HNPJ 0704									
TK HNPJ 07 001 WDA	✓	✓	50	4	40	22	HNPJ 0704	M4X11	T15
TK HNPJ 07 002 WDA	✓	✓	63	5	40	22			
TK HNPJ 07 003 WDA	✓	✓	63	6	40	22			
TK HNPJ 07 004 WDA	✓	✓	80	6	50	27			
TK HNPJ 07 005 WDA	✓	✗	80	8	50	27			
TK HNPJ 07 006 WDA	✓	✗	100	7	50	32			
TK HNPJ 07 007 WDA	✓	✗	125	8	63	40			
TK HNPJ 07 008 WDA	✓	✗	160	10	63	40			
TK HNPJ 07 009 WDA	✓	✓	50	5	40	22			

45° HN.. 0906 PRMT

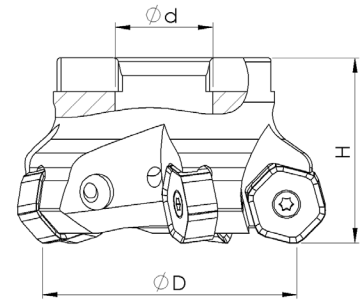

Kesici Uç Uyumluluğu Insert Suitability	Stok / Stock		Takım Ölçüleri / Dimension (mm)				Uç Insert	Vida Screw	Anahtar Torx Key
		Inter Cooland	D	Z	H	d			
PRMT HN.. 0906									
TK HN.. 09 001 PRMT	✓	✓	50	4	40	22	HN..0906	M4X14	T15
TK HN.. 09 002 PRMT	✓	✓	63	4	40	22			
TK HN.. 09 003 PRMT	✓	✓	80	6	50	27			
TK HN.. 09 004 PRMT	✓	✓	100	8	50	32			
TK HN.. 09 005 PRMT	✓	✗	125	10	62	40			
TK HN.. 09 006 PRMT	✓	✗	160	12	62	40			
TK HN.. 09 007 PRMT	✓	✗	200	10	62	60			
TK HN.. 09 008 PRMT	✓	✗	250	12	62	60			
TK HN.. 09 009 PRMT	✓	✗	300	14	62	60			
TK HN.. 09 010 PRMT	✓	✗	300	16	62	60			
TK HN.. 09 011 PRMT	✓	✓	63	5	40	22			

45° ODHT 0504 WLTR

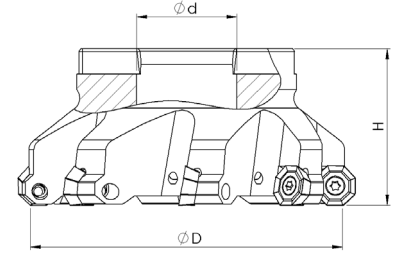

Kesici Uç Uyumluluğu Insert Suitability	Stok / Stock		Takım Ölçüleri / Dimension (mm)				Uç Insert	Vida Screw	Anahtar Torx Key
	WLTR ODHT 0504	Inter Cooland	D	Z	H	d			
TK ODHT 05 001 WLTR	✓	✓	80	6	50	27	ODHT 0504	M4X11	T15
TK ODHT 05 002 WLTR	✓	✓	100	8	50	32			
TK ODHT 05 003 WLTR	✓	X	125	10	62	40			

44° ONMU 0505 I

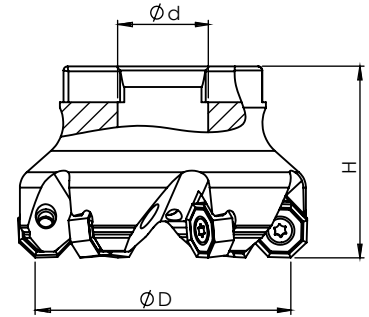

Kesici Uç Uyumluluğu Insert Suitability	Stok / Stock		Takım Ölçüleri / Dimension (mm)				Uç Insert	Vida Screw	Anahtar Torx Key
	I ON.. 05	Inter Cooland	D	Z	H	d			
TK ON.. 05 001 I	✓	✓	40	3	40	16	ON.. 05	M4,5X12	T20
TK ON.. 05 002 I	✓	✓	50	4	40	22			
TK ON.. 05 003 I	✓	✓	63	6	45	22			
TK ON.. 05 004 I	✓	✓	80	7	52	27			
TK ON.. 05 005 I	✓	X	100	8	52	32			
TK ON.. 05 006 I	✓	X	125	9	62	40			
TK ON.. 05 007 I	✓	X	160	9	62	40			

44° ONMX 1205 VNDRT

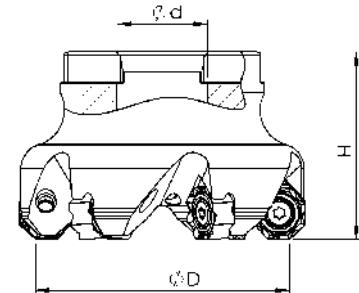

Kesici Uç Uyumluluğu Insert Suitability	Stok / Stock		Takım Ölçüleri / Dimension (mm)				Uç Insert	Vida Screw	Anahtar Torx Key
	VNDRT ONMX 1205	Inter Cooland	D	Z	H	d			
TK ONMX 12 001 VNDRT	✓	✓	80	6	45	27	ONMX 1205	M4,5X12	T20
TK ONMX 12 002 VNDRT	✓	✓	100	8	45	32			
TK ONMX 12 003 VNDRT	✓	X	125	10	50	40			

43° SYNU 0704 I

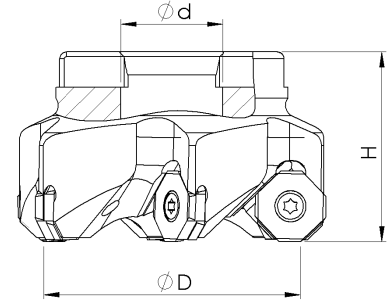

Kesici Uç Uyumluluğu
Insert Suitability

Stok / Stock

Takım Ölçüleri / Dimension (mm)

Uç
Insert

Vida
Screw

Anahtar
Torx Key

I
SYNU 0704

TK SYNU 07 001 I	Stok / Stock		Takım Ölçüleri / Dimension (mm)				Uç Insert	Vida Screw	Anahtar Torx Key
	✓	Inter Cooland	D	Z	H	d			
TK SYNU 07 001 I	✓	✓	50	5	40	22	SYNU 0704	M4X11	T15
TK SYNU 07 002 I	✓	✓	63	6	40	22			

40° NNMU 2007 MTSBSH

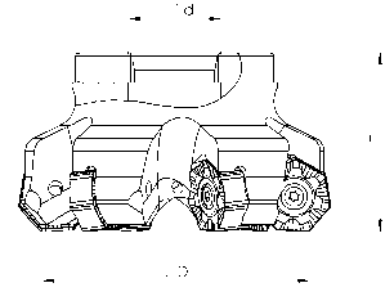

Kesici Uç Uyumluluğu
Insert Suitability

Stok / Stock

Takım Ölçüleri / Dimension (mm)

Uç
Insert

Vida
Screw

Anahtar
Torx Key

MTSBSH
NNMU 2007

TK NNMU 20 001 MTSBSH	Stok / Stock		Takım Ölçüleri / Dimension (mm)				Uç Insert	Vida Screw	Anahtar Torx Key
	✓	Inter Cooland	D	Z	H	d			
TK NNMU 20 001 MTSBSH	✓	✓	63	5	45	22	NNMU 2007	M5X16	T20
TK NNMU 20 002 MTSBSH	✓	✓	80	6	45	27			
TK NNMU 20 003 MTSBSH	✓	✓	100	7	50	32			
TK NNMU 20 004 MTSBSH	✓	X	125	8	50	40			
TK NNMU 20 005 MTSBSH	✓	X	160	10	55	40			
TK NNMU 20 006 MTSBSH	✓	X	200	12	55	60			
TK NNMU 20 007 MTSBSH	✓	X	200	12	55	60	NNMU 2006		

67° PNEG 1105 ZCC

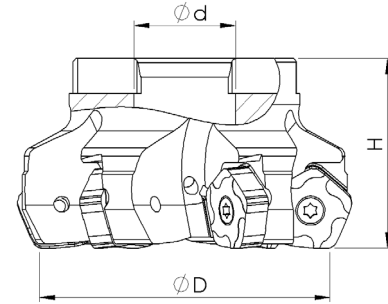

Kesici Uç Uyumluluğu
Insert Suitability

Stok / Stock

Takım Ölçüleri / Dimension (mm)

Uç
Insert

Vida
Screw

Anahtar
Torx Key

ZCC
PNEG 1105

TK PNEG 11 001 ZCC	Stok / Stock		Takım Ölçüleri / Dimension (mm)				Uç Insert	Vida Screw	Anahtar Torx Key
	✓	Inter Cooland	D	Z	H	d			
TK PNEG 11 001 ZCC	✓	✓	50	5	40	22	PNEG 1105	M4X11	T15
TK PNEG 11 002 ZCC	✓	✓	63	6	40	22			
TK PNEG 11 003 ZCC	✓	✓	80	8	50	27			
TK PNEG 11 004 ZCC	✓	✓	100	10	50	32			
TK PNEG 11 005 ZCC	✓	X	125	12	62	40			
TK PNEG 11 006 ZCC	✓	X	160	14	62	40			

Lütfen Sipariş vermeden önce stok durumunu sorunuz.
Please ask before ordering, stock status.

L: Sol / Left

R: Sağ / Right

✓ Stokta / In Stock

X Stokta Yok / Non Stock

SDMT 09T3 ZCC

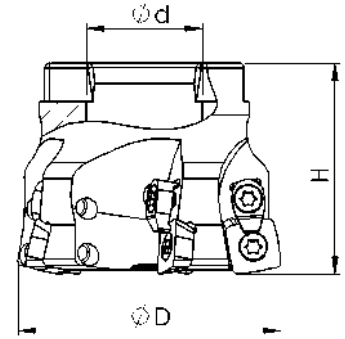

Kesici Uç Uyumluluğu Insert Suitability	Stok / Stock		Takım Ölçüleri / Dimension (mm)				Uç İnsert	Vida Screw	Pabuç Clamp	Vida Screw	Anahtar Torx Key
		Inter Cooland	D	Z	H	d					
ZCC SDMT 09T312											
TK SDMT 09 001 ZCC	✓	✓	40	4	40	16	SDMT 09T3	M3,5X11	CK14	M3,5X11	T15
TK SDMT 09 002 ZCC	✓	✓	50	4	40	22					
TK SDMT 09 003 ZCC	✓	✓	63	5	40	22					
TK SDMT 09 004 ZCC	✓	✓	50	5	40	22					
TK SDMT 09 005 ZCC	✓	✓	52	5	40	22					
TK SDMT 09 006 ZCC	✓	✓	52	6	40	22					
TK SDMT 09 007 ZCC	✓	✓	60	6	40	22					
TK SDMT 09 008 ZCC	✓	✓	63	6	40	22					
TK SDMT 09 009 ZCC	✓	✓	80	7	50	27					
TK SDMT 09 010 ZCC	✓	✓	100	8	50	32					

SDMT 1204 ZCC

NEW

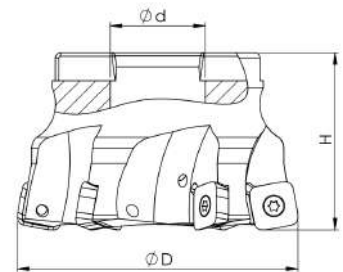

Kesici Uç Uyumluluğu Insert Suitability	Stok / Stock		Takım Ölçüleri / Dimension (mm)				Uç İnsert	Vida Screw	Anahtar Torx Key
		Inter Cooland	D	Z	H	d			
ZCC SDMT 1204									
TK SDMT 12 001 ZCC	✓	✓	50	5	40	22	SDMT 1204	M4X11	T15
TK SDMT 12 002 ZCC	✓	✓	52	4	40	22			
TK SDMT 12 003 ZCC	✓	✓	66	5	40	22			
TK SDMT 12 004 ZCC	✓	✓	66	5	40	27			
TK SDMT 12 005 ZCC	✓	✓	80	6	50	27			
TK SDMT 12 006 ZCC	✓	✓	50	4	40	22			
TK SDMT 12 007 ZCC	✓	✓	63	5	40	22			
TK SDMT 12 008 ZCC	✓	✓	100	8	50	32			

SDMT 1204 ISO

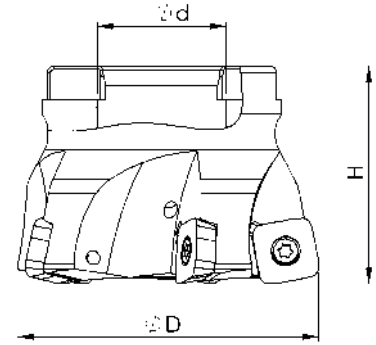

Kesici Uç Uyumluluğu Insert Suitability	Stok / Stock		Takım Ölçüleri / Dimension (mm)				Uç Insert	Vida Screw	Anahtar Torx Key
		Inter Cooland	D	Z	H	d			
ISO SDMT 1204									
TK SDMT 12 001 ISO	✓	✓	52	4	40	22	SDMT 1204	M4X11	T15
TK SDMT 12 002 ISO	✓	✓	66	5	45	22			
TK SDMT 12 003 ISO	✓	✓	80	6	50	27			

ZCDW 09T3 ZDEW 1204 PRMT

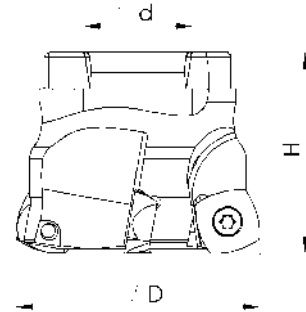

Kesici Uç Uyumluluğu Insert Suitability	Stok / Stock		Takım Ölçüleri / Dimension (mm)				Uç Insert	Vida Screw	Pabuç Clamp	Vida Screw	Anahtar Torx Key
		Inter Cooland	D	Z	H	d					
PRMT ZCDW 09T3 ZDEW 1204											
TK ZCDW 09 001 PRMT	✓	✓	40	4	40	16	ZCDW 09T304	M3X8	-	-	T10
TK ZDEW 12 002 PRMT	✓	✓	50	4	40	22	ZDEW 120408	M4X10	CK14	M4X10	T15
TK ZDEW 12 003 PRMT	✓	✓	63	5	40	22					

SDMT 1004 BHLR

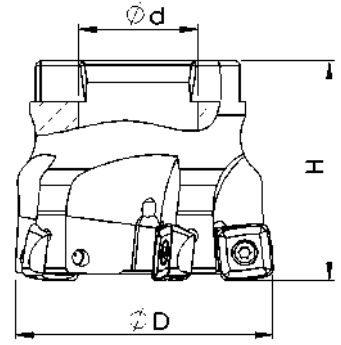

Kesici Uç Uyumluluğu Insert Suitability	Stok / Stock		Takım Ölçüleri / Dimension (mm)				Uç Insert	Vida Screw	Anahtar Torx Key
		Inter Cooland	D	Z	H	d			
BHLR SDMT 1004									
TK SDMT 10 002 BHLR	✓	✓	50	5	40	22	SDMT 1004	M3X10	T10
TK SDMT 10 003 BHLR	✓	✓	40	4	40	16			

SDMT 1206 ING

NEW

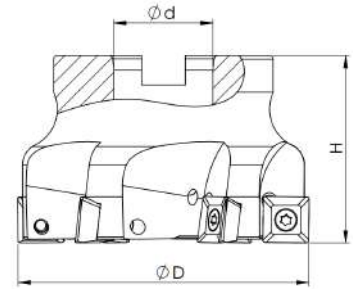

Kesici Uç Uyumluluğu Insert Suitability	Stok / Stock		Takım Ölçüleri / Dimension (mm)				Uç Insert	Vida Screw	Anahtar Torx Key
		Inter Cooland	D	Z	H	d			
ING SDMT 1206									
TK SDMT 12 001 ING	X	✓	63	5	50	22	SDMT 1206	M4X11	T15
TK SDMT 12 001 ING	X	✓	80	6	50	27			

SDMW 14 BHLR

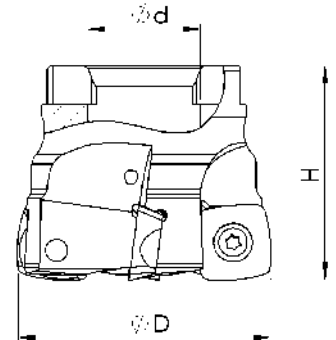

Kesici Uç Uyumluluğu Insert Suitability	Stok / Stock		Takım Ölçüleri / Dimension (mm)				Uç Insert	Vida Screw	Anahtar Torx Key
		Inter Cooland	D	Z	H	d			
BHLR SDMW 14									
TK SDMW 14 001 BHLR	✓	✓	50	4	42	22	SDMW 14	M5X12	T20
TK SDMW 14 004 BHLR	✓	✓	80	4	50	27			

SOEW 13M510 PLBT

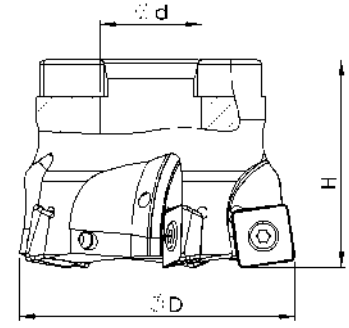

Kesici Uç Uyumluluğu Insert Suitability	Stok / Stock		Takım Ölçüleri / Dimension (mm)				Uç Insert	Vida Screw	Anahtar Torx Key
		Inter Cooland	D	Z	H	d			
PLBT SOEW 13M510									
TK SOEW 13 001 PLBT	✓	✓	52	4	40	22	SOEW 13	M4X11	T15
TK SOEW 13 002 PLBT	✓	✓	63	5	40	22			

SDMX 09T3 PLBT

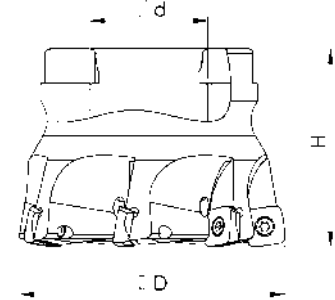

Kesici Uç Uyumluluğu Insert Suitability	Stok / Stock		Takım Ölçüleri / Dimension (mm)				Uç Insert	Vida Screw	Anahtar Torx Key
		Inter Cooland	D	Z	H	d			
PLBT SDMX 09T3									
TK SDMX 09 001 PLBT	✓	✓	42	6	40	16	SDMX 09T3	M3X8	T10
TK SDMX 09 002 PLBT	✓	✓	52	7	40	22			
TK SDMX 09 003 PLBT	✓	✓	80	9	50	27			
TK SDMX 09 004 PLBT	✓	✓	50	6	40	22			
TK SDMX 09 005 PLBT	✓	✓	63	7	45	22			

SOMT 1004/1405 KYCR

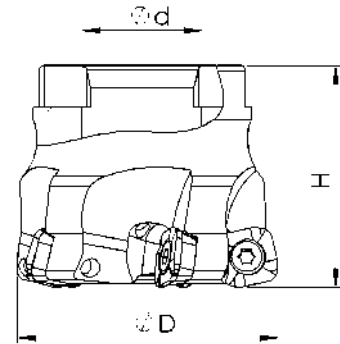

Kesici Uç Uyumluluğu Insert Suitability	Stok / Stock		Takım Ölçüleri / Dimension (mm)				Uç Insert	Vida Screw	Anahtar Torx Key
		Inter Cooland	D	Z	H	d			
KYCR SOMT 1004/1405									
TK SOMT 10 001 KYCR	✓	✓	50	5	40	22	SOMT 1004	M4X11	T15
TK SOMT 10 002 KYCR	✓	✓	52	5	50	22			
TK SOMT 14 003 KYCR	✓	✓	50	4	40	22	SOMT 1405	M5X12	T20
TK SOMT 14 004 KYCR	✓	✓	52	4	50	22			
TK SOMT 14 005 KYCR	✓	✓	63	5	40	22			
TK SOMT 14 006 KYCR	✓	✓	80	6	60	27			
TK SOMT 14 008 KYCR	✓	✓	66	5	40	27			

Lütfen Sipariş vermeden önce stok durumunu sorunuz.
Please ask before ordering, stock status.

L: Sol / Left

R: Sağ / Right

✓ Stokta / In Stock

✗ Stokta Yok / Non Stock

LOGU 0303 KYCR

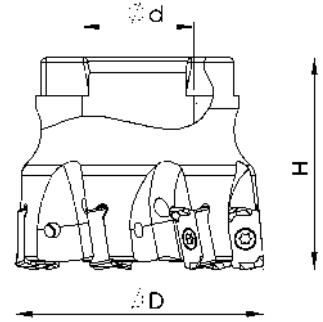

Kesici Uç Uyumluluğu Insert Suitability	Stok / Stock		Takım Ölçüleri / Dimension (mm)				Uç Insert	Vida Screw	Anahtar Torx Key
		Inter Cooland	D	Z	H	d			
KYCR LOGU 0303									
TK LOGU 03 001 KYCR	✓	✓	40	6	40	16	LOGU 0303	M3X8 LOGU	T8
TK LOGU 03 002 KYCR	✓	✓	50	7	50	22			
TK LOGU 03 003 KYCR	✓	✓	52	7	50	22			
TK LOGU 03 004 KYCR	✓	✓	52	6	50	22			
TK LOGU 03 005 KYCR	✓	✓	50	6	50	22			

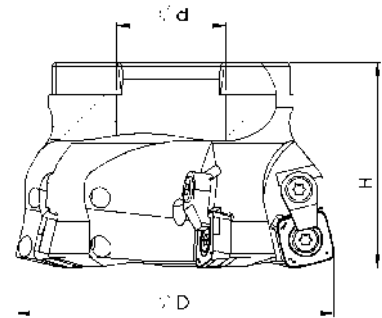

SPMW 1204 SNG



Kesici Uç Uyumluluğu Insert Suitability	Stok / Stock		Takım Ölçüleri / Dimension (mm)				Uç Insert	Vida Screw	Pabuç Clamp	Vida Screw	Anahtar Torx Key
		Inter Cooland	D	Z	H	d					
SNG SPMW 1204											
TK SPMW 12 001 SNG	✓	✓	50	5	50	22	SPMW 1204	M4X11	CK15	M4X11	T15
TK SPMW 12 002 SNG	✓	✓	80	5	50	27					
TK SPMW 12 003 SNG	✓	✓	80	8	50	27					
TK SPMW 12 004 SNG	✓	✓	100	8	50	32					
TK SPMW 12 005 SNG	✓	X	125	10	62	40					
TK SPMW 12 006 SNG	✓	X	160	12	62	40					
TK SPMW 12 007 SNG	✓	X	200	10	62	60					
TK SPMW 12 008 SNG	✓	✓	63	5	50	22					
TK SPMW 12 009 SNG	✓	✓	52	5	50	22					

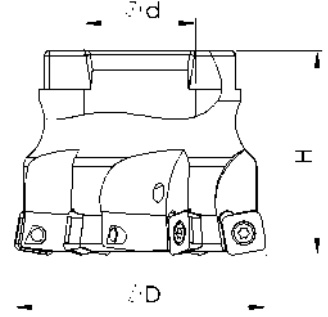





SOMW 080315 SNG

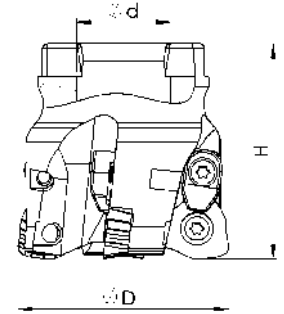

Kesici Uç Uyumluluğu Insert Suitability	Stok / Stock		Takım Ölçüleri / Dimension (mm)				Uç İnsert	Vida Screw	Anahtar Torx Key
		Inter Cooland	D	Z	H	d			
SNG SOMW 080315									
TK SOMW 08 001 SNG	✓	✓	40	5	40	16	SOMW 080315	M3X8	T10
TK SOMW 08 002 SNG	✓	✓	50	6	40	22			
TK SOMW 08 003 SNG	✓	✓	63	7	40	22			

JDMW 1405 VNDRT



Kesici Uç Uyumluluğu Insert Suitability	Stok / Stock		Takım Ölçüleri / Dimension (mm)				Uç İnsert	Vida Screw	Anahtar Torx Key	Pabuç Clamp	Vida Screw	Anahtar Torx Key
		Inter Cooland	D	Z	H	d						
VNDRT JDMW 1405												
TK JDMW 14 001 VNDRT	✓	✓	50	4	50	22	JDMW 1405	M5X12	T20	CK15	M4X11	T15
TK JDMW 14 002 VNDRT	✓	✓	63	5	50	22						

WDMX 1204 VNDRT

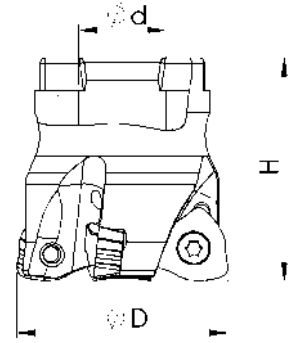

Kesici Uç Uyumluluğu Insert Suitability	Stok / Stock		Takım Ölçüleri / Dimension (mm)				Uç Insert	Vida Screw	Anahtar Torx Key
		Inter Cooland	D	Z	H	d			
VNDRT WDMX 1204									
TK WDMX 12 001 VNDRT	✓	✓	40	4	40	16	WDMX 1204	M4X11	T15
TK WDMX 12 002 VNDRT	✓	✓	50	5	40	22			

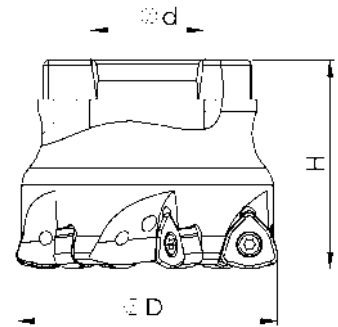

WNMX 09T3/1305 KRLY



Kesici Uç Uyumluluğu Insert Suitability	Stok / Stock		Takım Ölçüleri / Dimension (mm)				Uç Insert	Vida Screw	Anahtar Torx Key
		Inter Cooland	D	Z	H	d			
KRLY WNMX 09T3/1305									
TK WNMX 09 001 KRLY	✓	✓	40	3	40	16	WNMX 09T316	M3X10	T10
TK WNMX 09 002 KRLY	✓	✓	40	4	40	16			
TK WNMX 09 003 KRLY	✓	✓	50	4	40	22			
TK WNMX 09 004 KRLY	✓	✓	52	4	40	22			
TK WNMX 09 005 KRLY	✓	✓	52	5	40	22			
TK WNMX 09 006 KRLY	✓	✓	52	6	40	22			
TK WNMX 09 007 KRLY	✓	✓	63	5	50	22			
TK WNMX 09 008 KRLY	✓	✓	66	6	50	22			
TK WNMX 09 009 KRLY	✓	✓	66	6	50	27			
TK WNMX 09 010 KRLY	✓	✓	50	3	40	22			
TK WNMX 13 010 KRLY	✓	✓	63	4	40	22	WNMX 130520	M4X11	T15
TK WNMX 13 011 KRLY	✓	✓	80	5	50	27	WNMX 09T316	M3X10	T10
TK WNMX 09 012 KRLY	✓	✓	80	7	50	27	WNMX 130520	M4X11	T15
TK WNMX 13 013 KRLY	✓	✓	52	4	40	22	WNMX 130520	M4X11	T15

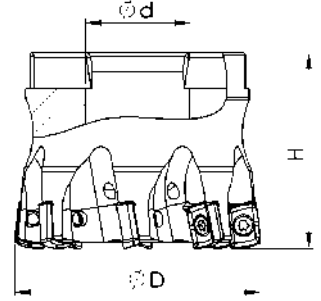

LNMT 060310R KRLY



Kesici Uç Uyumluluğu Insert Suitability	Stok / Stock		Takım Ölçüleri / Dimension (mm)				Uç İnsert	Vida Screw	Anahtar Torx Key
		Inter Cooland	D	Z	H	d			
KRLY LNMT 0603									
TK LNMT 06 001 KRLY	✓	✓	40	6	40	16	LNMT 0603	M3X8	T10
TK LNMT 06 002 KRLY	✓	✓	52	8	40	22			
TK LNMT 06 003 KRLY	✓	✓	63	9	50	22			
TK LNMT 06 004 KRLY	✓	✓	66	9	50	27			

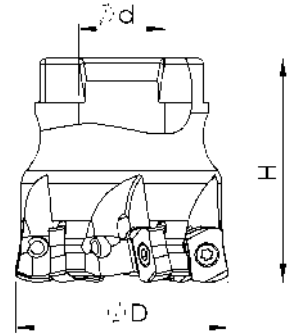

LNMX 060310R KRLY



Kesici Uç Uyumluluğu Insert Suitability	Stok / Stock		Takım Ölçüleri / Dimension (mm)				Uç İnsert	Vida Screw	Anahtar Torx Key
		Inter Cooland	D	Z	H	d			
KRLY LNMX 060310									
TK LNMX 06 001 KRLY	✓	✓	42	6	40	16	LNMX 060310	M2,5X7	T8
TK LNMX 06 002 KRLY	✓	✓	52	7	40	22			
TK LNMX 06 003 KRLY	✓	✓	52	8	40	22			
TK LNMX 06 005 KRLY	✓	✓	50	7	40	22			
TK LNMX 06 006 KRLY	✓	✓	63	8	50	22			
TK LNMX 06 007 KRLY	✓	✓	80	10	50	27			

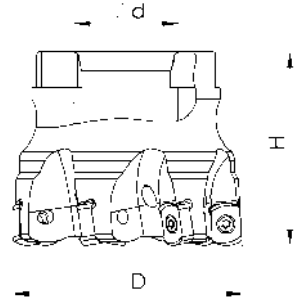

BLM 0603 TT

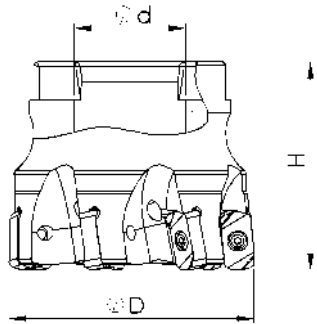

Kesici Uç Uyumluluğu Insert Suitability	Stok / Stock		Takım Ölçüleri / Dimension (mm)				Uç Insert	Vida Screw	Anahtar Torx Key
		Inter Cooland	D	Z	H	d			
TT BLM 0603									
TK BLM 06 001 TT	✓	✓	40	6	40	16	BLM 0603	M2,5X7	T8
TK BLM 06 002 TT	✓	✓	50	7	50	22			
TK BLM 06 003 TT	✓	✓	63	8	50	22			

LNMU 0303 TNGLY



Kesici Uç Uyumluluğu Insert Suitability	Stok / Stock		Takım Ölçüleri / Dimension (mm)				Uç Insert	Vida Screw	Anahtar Torx Key
		Inter Cooland	D	Z	H	d			
TNGLY LNMU 0303									
TK LNMU 03 001 TNG	✓	✓	40	6	40	16	LNMU 0303	M2,5X8	T8
TK LNMU 03 002 TNG	✓	✓	50	7	40	22			
TK LNMU 03 003 TNG	✓	✓	63	8	40	22			
TK LNMU 03 004 TNG	✓	✓	52	7	40	22			

WDMT 0805 DJT

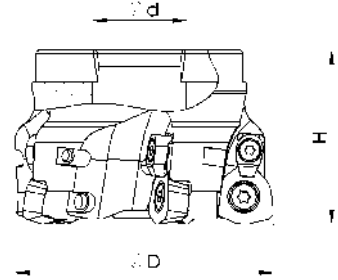

Kesici Uç Uyumluluğu Insert Suitability	Stok / Stock		Takım Ölçüleri / Dimension (mm)				Uç Insert	Vida Screw	Pabuç Clamp	Vida Screw	Anahtar Torx Key
		Inter Cooland	D	Z	H	d					
DJT WDMT 0805											
TK WDMT 08 001 DJT	✓	✓	42	3	40	16	WDMT 0805	M4,5X15	CK15	M4X11	T20
TK WDMT 08 002 DJT	✓	✓	50	4	40	22					
TK WDMT 08 003 DJT	✓	✓	63	5	40	22					

XDPT 0904 WDA

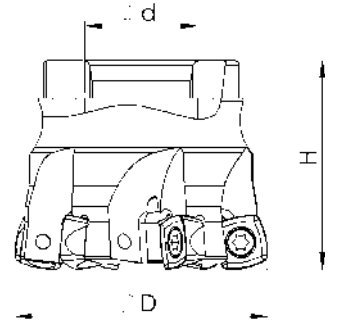

Kesici Uç Uyumluluğu Insert Suitability	Stok / Stock		Takım Ölçüleri / Dimension (mm)				Uç Insert	Vida Screw	Anahtar Torx Key
		Inter Cooland	D	Z	H	d			
WDA XDPT 0904									
TK XDPT 09 001 WDA	✓	✓	40	5	40	16	XDPT 0904	M3,5X11	T15
TK XDPT 09 002 WDA	✓	✓	50	5	40	22			
TK XDPT 09 003 WDA	✓	✓	50	6	40	22			
TK XDPT 09 004 WDA	✓	✓	52	6	40	22			

P26335 WLTR

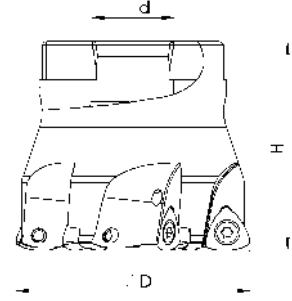

Kesici Uç Uyumluluğu Insert Suitability	Stok / Stock		Takım Ölçüleri / Dimension (mm)				Uç İnsert	Vida Screw	Anahtar Torx Key
		Inter Cooland	D	Z	H	d			
WLTR P26335									
TK P26335 001 WLTR	✓	✓	50	5	40	22	P26335R-14	M4X11	T15
TK P26335 002 WLTR	✓	✓	52	5	55	22			
TK P26335 003 WLTR	✓	✓	63	6	55	22			
TK P26335 004 WLTR	✗	✓	52	3	40	22	P26335R-25	M4,5X15	T20
TK P26335 005 WLTR	✓	✓	50	4	40	22	P26335R-10	M2,5X7	T8

UNEU 1307R INGRSL

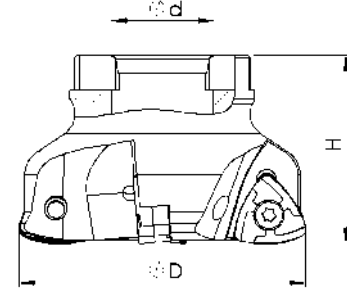

Kesici Uç Uyumluluğu Insert Suitability	Stok / Stock		Takım Ölçüleri / Dimension (mm)				Uç İnsert	Vida Screw	Anahtar Torx Key
		Inter Cooland	D	Z	H	d			
INGRSL UNEU 1307R									
TK UNEU 13 001 INGRSL	✓	✓	52	3	40	22	UNEU 1307R	M4,5X12	T20
TK UNEU 13 002 INGRSL	✓	✓	63	4	40	22			

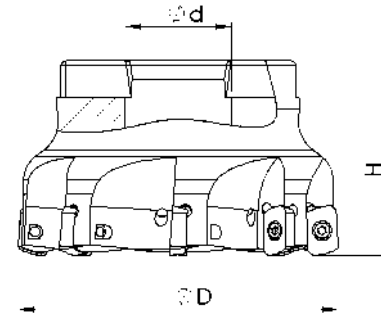

EPNW 0603 KC



Kesici Uç Uyumluluğu Insert Suitability	Stok / Stock		Takım Ölçüleri / Dimension (mm)				Uç İnsert	Vida Screw	Anahtar Torx Key
		Inter Cooland	D	Z	H	d			
KC EPNW 0603									
TK EPNW 06 001 KC	✗	✓	52	7	40	22	EPNW 0603	M2,5X7	T8
TK EPNW 06 002 KC	✗	✓	63	8	40	22			

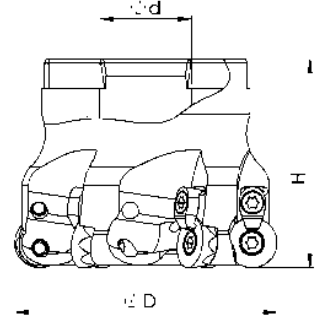

RPMT 10T3 KYCR

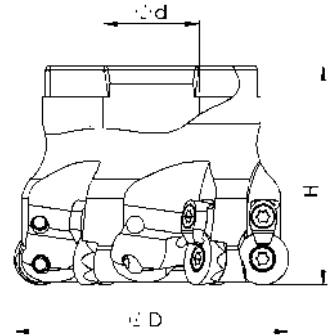

Kesici Uç Uyumluluğu Insert Suitability	Stok / Stock		Takım Ölçüleri / Dimension (mm)				Uç İnsert	Vida Screw	Anahtar Torx Key
		Inter Cooland	D	Z	H	d			
KYCR RPMT 10T3									
TK RPMT 10 001 KYCR	✓	✓	35	4	40	16	RPMT 10T3	M3X8	T10
TK RPMT 10 002 KYCR	✓	✓	40	5	40	16			
TK RPMT 10 003 KYCR	✓	✓	50	6	40	22			

RPMT 1204 KYCR



Kesici Uç Uyumluluğu Insert Suitability	Stok / Stock		Takım Ölçüleri / Dimension (mm)				Uç İnsert	Vida Screw	Anahtar Torx Key
		Inter Cooland	D	Z	H	d			
KYCR RPMT 1204									
TK RPMT 12 001 KYCR	✓	✓	40	4	45	16	RPMT 1204	M4X11	T15
TK RPMT 12 002 KYCR	✓	✓	52	3	50	22			
TK RPMT 12 003 KYCR	✓	✓	52	5	50	22			
TK RPMT 12 004 KYCR	✓	✓	63	6	50	22			
TK RPMT 12 005 KYCR	X	✓	66	6	50	22			
TK RPMT 12 006 KYCR	X	✓	66	6	50	27			

RDkW 1003/12T3/1204 1604/2006 ISO

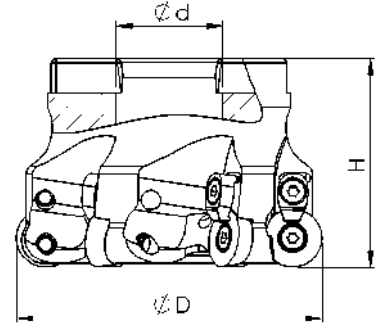

Kesici Uç Uyumluluğu Insert Suitability	Stok / Stock		Takım Ölçüleri / Dimension (mm)				Uç Insert	Vida Screw	Pabuç Clamp	Vida Screw	Anahtar Torx Key
	✓	Inter Coolant	D	Z	H	d					
ISO RDkV 1003/12T3 1204/1604/2006											
TK RD..10 001 ISO	✓	✓	40	4	40	16	RDkW 1003	M3,5X10	CK14	M3,5X8	T15
TK RD..10 002 ISO	✓	✓	50	5	46	22					
TK RD..10 003 ISO	✓	✓	63	6	50	22					
TK RD..10 004 ISO	✓	✓	80	7	52	27					
TK RD..10 005 ISO	✓	✓	100	8	52	32					
TK RD..12 006 ISO	✓	✓	40	4	40	16	RDkW 12T3	M3,5X10	CK14	M3,5X8	T15
TK RD..12 007 ISO	✓	✓	50	5	46	22					
TK RD..12 008 ISO	✓	✓	52	5	46	22					
TK RD..12 009 ISO	✓	✓	63	6	50	22					
TK RD..12 010 ISO	✓	✓	80	7	52	27					
TK RD..12 011 ISO	✓	✓	100	8	52	32	RDkW 1204	M3,5X10	CK14	M3,5X8	T15
TK RD..12 012 ISO	✓	✓	40	4	40	16					
TK RD..12 013 ISO	✓	✓	50	5	46	22					
TK RD..12 014 ISO	✓	✓	63	6	50	22					
TK RD..12 015 ISO	✓	✓	80	7	52	27					
TK RD..12 016 ISO	✓	✓	100	8	52	32	RDkW 12T3	M3,5X10	CK14	M3,5X8	T15
TK RD..12 017 ISO	✓	X	125	9	62	40					
TK RD..12 027 ISO	✓	X	125	9	62	40					
TK RD..12 028 ISO	✓	X	160	12	62	40					
TK RD..16 016 ISO	✓	✓	50	4	50	22					
TK RD..16 017 ISO	✓	✓	52	4	50	22					
TK RD..16 018 ISO	✓	✓	63	4	50	22					
TK RD..16 019 ISO	✓	✓	66	5	50	27					
TK RD..16 020 ISO	✓	✓	80	5	52	27					
TK RD..16 021 ISO	✓	✓	100	6	52	32					
TK RD..16 022 ISO	✓	X	125	7	62	40					
TK RD..16 023 ISO	✓	X	160	8	62	40					
TK RD..16 024 ISO	✓	X	180	11	62	60					
TK RD..16 025 ISO	✓	X	200	12	62	60					
TK RD.. 16 026 ISO	✓	X	160	10	62	40	RDkW 12T3	M3,5X10	CK14	M3,5X8	T15

RDKW 10T3 ISO

NEW

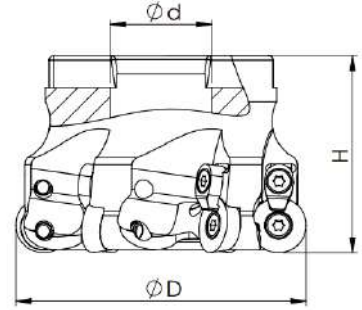

Kesici Uç Uyumluluğu Insert Suitability	Stok / Stock		Takım Ölçüleri / Dimension (mm)				Uç Insert	Vida Screw	Pabuç Clamp	Vida Screw	Anahtar Torx Key
		Inter Cooland	D	Z	H	d					
ISO RDKW 10T3											
TK RDKW 10 001 ISO	✓	✓	50	5	40	22	RDKW 10T3	M3,5X10	CK14	M3,5X8	T15
TK RDKW 10 002 ISO	✓	✓	63	6	40	22					
TK RDKW 10 003 ISO	✓	✓	80	7	50	27					

RPMT 1204 ISO

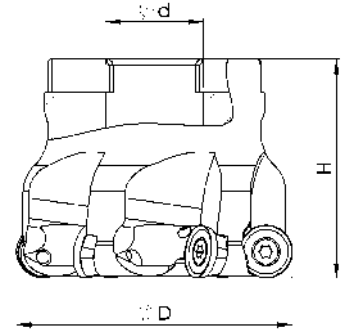

Kesici Uç Uyumluluğu Insert Suitability	Stok / Stock		Takım Ölçüleri / Dimension (mm)				Uç Insert	Vida Screw	Pabuç Clamp	Vida Screw	Anahtar Torx Key
		Inter Cooland	D	Z	H	d					
ISO RPMT 1204											
TK RPMT 12 001 ISO	✓	✓	40	4	40	16	RPMT 1204	M3,5X11	CK15	M3,5X11	T15
TK RPMT 12 002 ISO	✓	✓	50	5	40	22					
TK RPMT 12 003 ISO	✓	✓	52	5	40	22					
TK RPMT 12 004 ISO	✓	✓	63	6	40	22					
TK RPMT 12 005 ISO	✓	✓	80	7	50	27					
TK RPMT 12 001 ZCC	✓	✓	40	4	40	16		M3,5X10	CK14	M3,5X8	
TK RPMT 12 002 ZCC	✓	✓	50	5	40	22					
TK RPMT 12 003 ZCC	✓	✓	63	6	40	22					

RPMW 1003 ISO

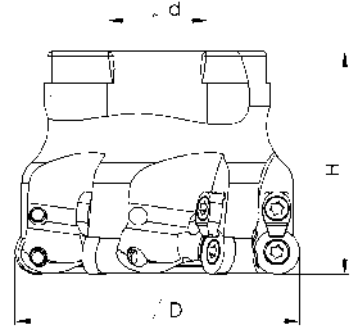

Kesici Uç Uyumluluğu Insert Suitability	Stok / Stock		Takım Ölçüleri / Dimension (mm)				Uç Insert	Vida Screw	Pabuç Clamp	Vida Screw	Anahtar Torx Key
		Inter Cooland	D	Z	H	d					
ISO RPMW 1003											
TK RPMW 10 001 ISO	✓	✓	40	4	40	16	RPMW 1003	M3,5X11	CK15	M3,5X11	T15
TK RPMW 10 002 ISO	✓	✓	50	5	40	22					
TK RPMW 10 003 ISO	✓	✓	63	6	40	22					
TK RPMW 10 004 ISO	✓	✓	80	7	50	27					

RPMT 1204 TNG

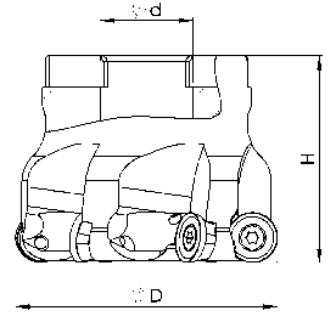

Kesici Uç Uyumluluğu Insert Suitability	Stok / Stock		Takım Ölçüleri / Dimension (mm)				Uç Insert	Vida Screw	Anahtar Torx Key
		Inter Cooland	D	Z	H	d			
TNG RPMT 1204									
TK RPMT 12 001 TNG	✓	✓	40	4	40	16	RPMT 1204	M4X11	T15
TK RPMT 12 002 TNG	✓	✓	50	5	42	22			
TK RPMT 12 003 TNG	✓	✓	63	6	42	22			

RPMT 10T3 TNG

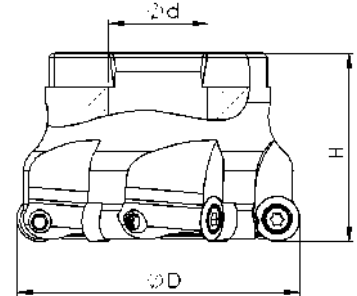

Kesici Uç Uyumluluğu Insert Suitability	Stok / Stock		Takım Ölçüleri / Dimension (mm)				Uç Insert	Vida Screw	Anahtar Torx Key
		Inter Cooland	D	Z	H	d			
TNG RPMT 10T3									
TK RPMT 10T3 001 TNG	✓	✓	40	4	42	16	RPMT 10T3	M3,5X11	T15
TK RPMT 10T3 002 TNG	✓	✓	50	5	42	22			
TK RPMT 10T3 003 TNG	✓	✓	63	6	42	22			

RCKT 1204/1606 ISO

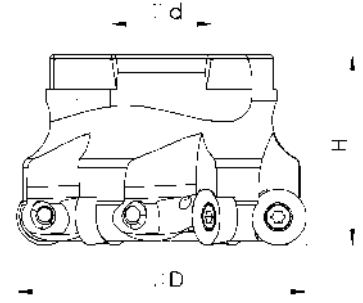

Kesici Uç Uyumluluğu Insert Suitability	Stok / Stock		Takım Ölçüleri / Dimension (mm)				Uç İnsert	Vida Screw	Anahtar Torx Key
		Inter Cooland	D	Z	H	d			
ISO RCKT 1204/1606									
TK RCKT 12 000 ISO	✓	✓	40	4	40	16	RCKT1204	M3,5X8	T15
TK RCKT 12 001 ISO	✓	✓	63	6	40	22	RCKT1606	M6X16	T25
TK RCKT 12 002 ISO	✓	✓	52	4	50	22			
TK RCKT 16 003 ISO	✓	✓	63	4	40	22	RCKT1204	M3,5X8	T15
TK RCKT 16 004 ISO	✓	✓	80	5	50	27			
TK RCKT 16 005 ISO	✓	✓	80	7	50	27			
TK RCKT 12 006 ISO	✓	✓	50	5	40	22			

ROMX 2006 WLTR

NEW

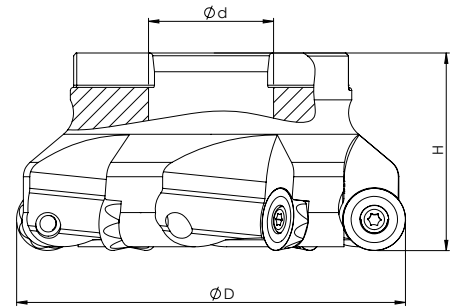

Kesici Uç Uyumluluğu Insert Suitability	Stok / Stock		Takım Ölçüleri / Dimension (mm)				Uç İnsert	Vida Screw	Anahtar Torx Key
		Inter Cooland	D	Z	H	d			
WLTR ROMX 2006									
TK ROMX 20 003 WLTR	✓	X	125	6	62	40	ROMX 2006	M3X10	T10
TK ROMX 20 004 WLTR	✓	X	160	7	62	40			
TK ROMX 20 005 WLTR	✓	X	200	9	62	60			



VIDALI TARAMALAR SCREW TYPE

90° AP..1003/1604 ISO

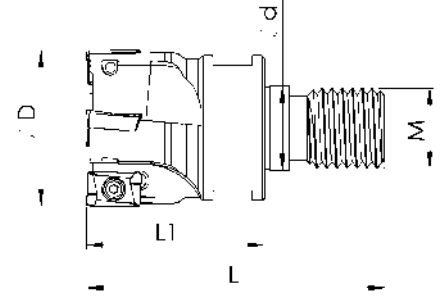

Kesici Uç Uyumluluğu Insert Suitability	Stok / Stock		Takım Ölçüleri / Dimension (mm)						Uç Insert	Vida Screw	Anahtar Torx Key
	ISO AP.. 1003/1604	Inter Cooland	D	Z	L1	L	d	M			
VT AP..10 001 ISO	✓	X	25	3	38	60	12,5	M12	AP..1003	M2,5X7	T08
VT AP..10 002 ISO	✓	X	32	4	36	60	17	M16			
VT AP..10 003 ISO	✓	X	35	4	36	60	17	M16			
VT AP..10 004 ISO	✓	X	35	5	36	60	17	M16			
VT AP..10 005 ISO	✓	X	40	5	36	60	17	M16			
VT AP..10 006 ISO	✓	X	42	5	36	60	17	M16			
VT AP..10 007 ISO	✓	X	16	2	33	50	8,5	M08			
VT AP..10 008 ISO	✓	X	20	3	32	51	10,5	M10			
VT AP..16 007 ISO	✓	X	25	2	38	60	12,5	M12	AP..1604	M3,5X9	T15
VT AP..16 008 ISO	✓	X	32	3	44	68	17	M16			
VT AP..16 009 ISO	✓	X	40	4	44	68	17	M16			

90° APMT 11T3

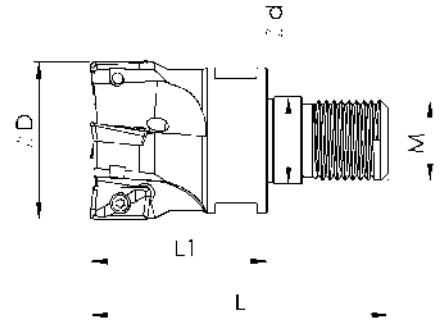

Kesici Uç Uyumluluğu Insert Suitability	Stok / Stock		Takım Ölçüleri / Dimension (mm)						Uç Insert	Vida Screw	Anahtar Torx Key
	APMT 11T3	Inter Cooland	D	Z	L1	L	d	M			
VT APMT 11 001	✓	X	20	3	31	50	10,5	M10	APMT 11T3	M2,5X7	T8
VT APMT 11 002	✓	X	25	3	29	50	12,5	M12			
VT APMT 11 003	✓	X	25	4	29	50	12,5	M12			
VT APMT 11 004	✓	X	32	4	36	60	17	M16			
VT APMT 11 005	✓	X	40	5	36	60	17	M16			

90° BDMT 11T3/1704 KYCR

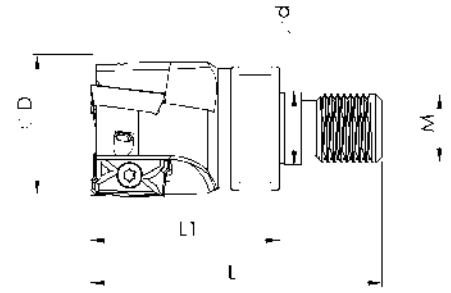

Kesici Uç Uyumluluğu Insert Suitability	Stok / Stock		Takım Ölçüleri / Dimension (mm)						Uç Insert	Vida Screw	Anahtar Torx Key
	Inter Cooland		D	Z	L1	L	d	M			
KYCR BDMT 11T3/1704											
VT BDMT 11 001 KYCR	✓	✓	20	3	31	50	10,5	M10	BDMT 11T3	M2,5X7	T08
VT BDMT 11 002 KYCR	✓	✓	25	3	29	50	12,5	M12			
VT BDMT 11 003 KYCR	✓	✓	35	4	36	60	17	M16			
VT BDMT 17 004 KYCR	✓	✓	25	2	38	60	12,5	M12	BDMT 1704	M4X10	T15
VT BDMT 17 005 KYCR	✓	✓	32	3	36	60	12,5	M12			

90° WNMU 0504 KYCR

NEW

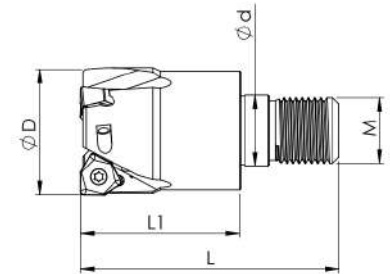

Kesici Uç Uyumluluğu Insert Suitability	Stok / Stock		Takım Ölçüleri / Dimension (mm)						Uç Insert	Vida Screw	Anahtar Torx Key
	Inter Cooland		D	Z	L1	L	d	M			
KYCR WNMU 0504											
VT WNMU 05 001 KYCR	✓	✓	32	3	38	62	17	M16	WNMU 0504	M3X8	T10

90° AOMT 1236 MTSBSH

NEW

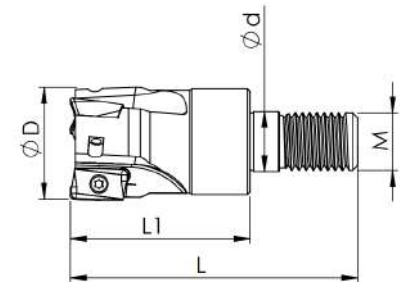

Kesici Uç Uyumluluğu Insert Suitability	Stok / Stock		Takım Ölçüleri / Dimension (mm)						Uç Insert	Vida Screw	Anahtar Torx Key
	Inter Cooland		D	Z	L1	L	d	M			
MTSBSH AOMT 1236											
VT AOMT 12 002 MTSBSH	✓	✓	25	3	38	60	12,5	12	AOMT 1236	M2,5X7	T8

90° XNEX 0403 SCO

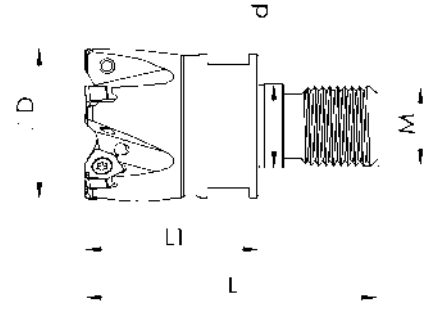

Kesici Uç Uyumluluğu Insert Suitability	Stok / Stock		Takım Ölçüleri / Dimension (mm)						Uç Insert	Vida Screw	Anahtar Torx Key
	Inter Cooland		D	Z	L1	L	d	M			
SCO XNEX 0403											
VT XNEX 04 000 SCO	✓	✓	25	4	28	50	12,5	M12	XNEX 0403	M3X10	T10
VT XNEX 04 001 SCO	✓	✓	32	5	36	60	17	M16			
VT XNEX 04 002 SCO	✓	✓	40	6	36	60	17	M16			
VT XNEX 04 003 SCO	✓	✓	32	4	36	60	17	M16			

90° XOMX 1204 SCO

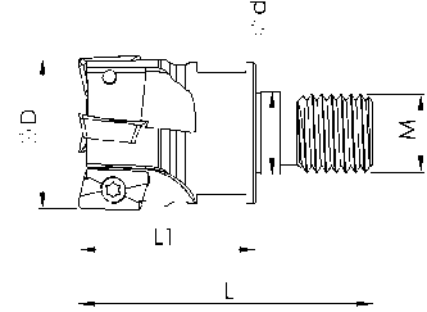

Kesici Uç Uyumluluğu Insert Suitability	Stok / Stock		Takım Ölçüleri / Dimension (mm)						Uç Insert	Vida Screw	Anahtar Torx Key
	Inter Cooland		D	Z	L1	L	d	M			
SCO XOMX 1204..											
VT XOMX 12 001 SCO	✓	✓	25	3	38	60	12,5	M12	XOMX 1204	M3,5X8	T15
VT XOMX 12 002 SCO	✓	✓	32	4	36	60	17	M16			

90° 3PKT 1004 TT

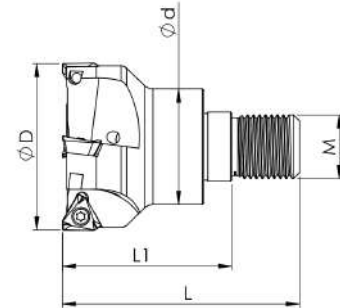

Kesici Uç Uyumluluğu Insert Suitability	Stok / Stock		Takım Ölçüleri / Dimension (mm)						Uç Insert	Vida Screw	Anahtar Torx Key
	Inter Cooland		D	Z	L1	L	d	M			
TT 3PKT 1004											
VT 3PKT 10 002 TT	✓	✓	32	4	36	60	17	M16	3PKT 1004	M3X8	T10
VT 3PKT 10 004 TT	✓	✓	42	4	36	60	17	M16			

90° BOMT 1304 INGRSL

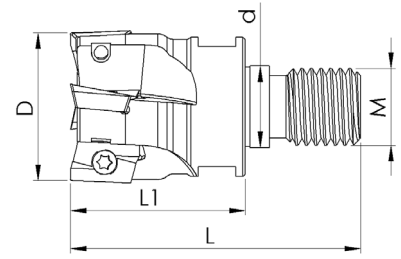

Kesici Uç Uyumluluğu Insert Suitability	Stok / Stock		Takım Ölçüleri / Dimension (mm)						Uç İnsert	Vida Screw	Anahtar Torx Key
	Inter Cooland		D	Z	L1	L	d	M			
INGRSL BOMT 1304											
VT BOMT 13 001 INGRSL	✓	X	25	3	38	60	12,5	M12	BOMT 1304	M3,5X8	T15
VT BOMT 13 002 INGRSL	✓	X	32	4	36	60	17	M16			

90° AOMT 1605 INGRSL

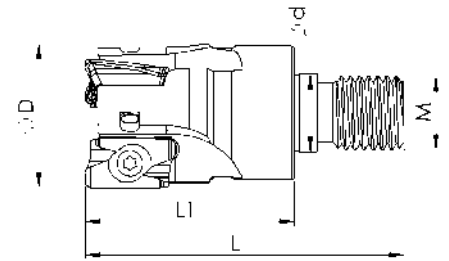

Kesici Uç Uyumluluğu Insert Suitability	Stok / Stock		Takım Ölçüleri / Dimension (mm)						Uç İnsert	Vida Screw	Anahtar Torx Key
	Inter Cooland		D	Z	L1	L	d	M			
INGRSL AOMT 160508											
VT AOMT 16 001 INGRSL	✓	X	25	2	38	60	12,5	M12	AOMT 1605	M4X10	T15
VT AOMT 16 002 INGRSL	✓	X	32	3	44	68	17	M16			
VT AOMT 16 003 INGRSL	✓	X	40	4	44	68	17	M16			

90° XDPT 1104 WDA

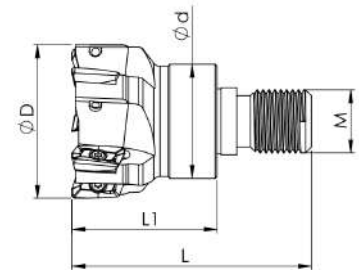

Kesici Uç Uyumluluğu Insert Suitability	Stok / Stock		Takım Ölçüleri / Dimension (mm)						Uç İnsert	Vida Screw	Anahtar Torx Key
	Inter Cooland		D	Z	L1	L	d	M			
WDA XDPT 1104											
VT XDPT 11 002 WDA	X	✓	32	4	36	60	17	M16	XDPT 1104	M2,5X8	T8
VT XDPT 11 003 WDA	X	✓	42	5	36	60	17	M16			

90° TNGX 1004 PRMT

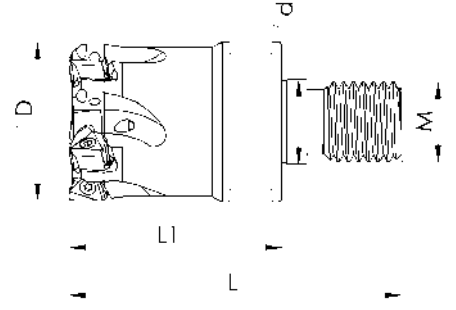

Kesici Uç Uyumluluğu Insert Suitability	Stok / Stock		Takım Ölçüleri / Dimension (mm)						Uç Insert	Vida Screw	Anahtar Torx Key
		Inter Cooland	D	Z	L1	L	d	M			
PRMT TNGX 1004											
VT TNGX 10 001 PRMT	✓	✓	25	4	33	55	12,5	M12	TNGX 1004	M2,5X7	T8
VT TNGX 10 002 PRMT	✓	✓	32	5	42	66	17	M16			

90° APMT 1135 SNG

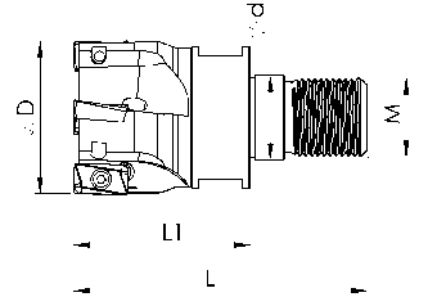

Kesici Uç Uyumluluğu Insert Suitability	Stok / Stock		Takım Ölçüleri / Dimension (mm)						Uç Insert	Vida Screw	Anahtar Torx Key
		Inter Cooland	D	Z	L1	L	d	M			
SNG APMT 1135											
VT APMT 11 001 SNG	✓	✓	16	2	33	50	8,5	M8	APMT 1135	M2,5	T8
VT APMT 11 002 SNG	✓	✓	20	3	31	50	10,5	M10			
VT APMT 11 003 SNG	✓	✓	25	3	38	60	12,5	M12			
VT APMT 11 004 SNG	✓	✓	32	4	36	60	17	M16			

90° XDKT 1505 CRTZ

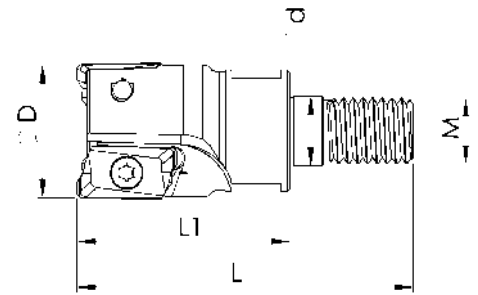

Kesici Uç Uyumluluğu Insert Suitability	Stok / Stock		Takım Ölçüleri / Dimension (mm)						Uç Insert	Vida Screw	Anahtar Torx Key
		Inter Cooland	D	Z	L1	L	d	M			
CRTZ XDKT 1505											
VT XDKT 15 001 CRTZ	✓	✗	25	2	38	60	12,5	M12	XDKT 1505	M4X11	T15
VT XDKT 15 002 CRTZ	✓	✗	32	3	36	60	17	M16			

90° XDHT 1904 CRTZT

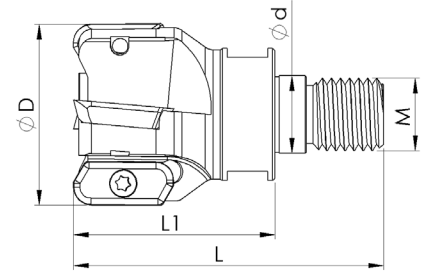

Kesici Uç Uyumluluğu Insert Suitability	Stok / Stock		Takım Ölçüleri / Dimension (mm)						Uç Insert	Vida Screw	Anahtar Torx Key
		Inter Cooland	D	Z	L1	L	d	M			
CRTZT XDHT 1904											
VT XDHT 19 001 CRTZT	✓	X	25	2	38	60	12,5	M12	XDHT 1904	M4X11	T15
VT XDHT 19 002 CRTZT	✓	X	40	4	36	60	17	M16			

90° APMT 11T308 KRLY

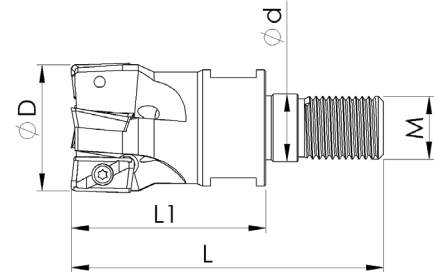

Kesici Uç Uyumluluğu Insert Suitability	Stok / Stock		Takım Ölçüleri / Dimension (mm)						Uç Insert	Vida Screw	Anahtar Torx Key
		Inter Cooland	D	Z	L1	L	d	M			
KRLY APMT 11T308											
VT APMT 11 001 KRLY	✓	✓	20	3	31	50	10,5	M10	APMT 11T308	M2,5X6	T8
VT APMT 11 002 KRLY	✓	✓	25	4	38	60	12,5	M12		M2,5X7	
VT APMT 11 003 KRLY	✓	✓	32	4	36	60	17	M16			

90° XNKT 0604 KRLY

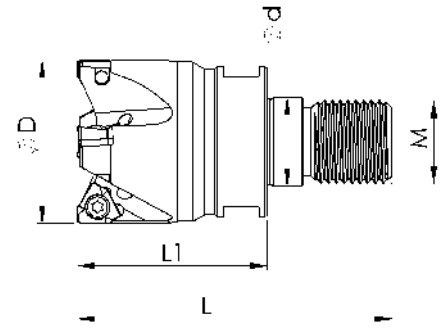

Kesici Uç Uyumluluğu Insert Suitability	Stok / Stock		Takım Ölçüleri / Dimension (mm)						Uç İnsert	Vida Screw	Anahtar Torx Key
		Inter Cooland	D	Z	L1	L	d	M			
KRLY XNKT 0604											
VT XNKT 06 001 KRLY	✓	✓	25	3	28	50	12,5	M12	XNKT 0604	M2,5X7	T8
VT XNKT 06 002 KRLY	✓	✓	32	4	36	60	17	M16			
VT XNKT 06 004 KRLY	✓	✓	42	5	36	60	17	M16			
VT XNKT 06 005 KRLY	✓	✓	17	2	33	50	8,5	M8			
VT XNKT 06 006 KRLY	✓	✓	20	2	31	50	10,5	M10			

90° XNKT 0805 KRLY

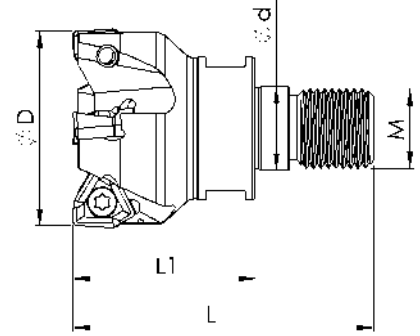

Kesici Uç Uyumluluğu Insert Suitability	Stok / Stock		Takım Ölçüleri / Dimension (mm)						Uç İnsert	Vida Screw	Anahtar Torx Key
		Inter Cooland	D	Z	L1	L	d	M			
KRLY XNKT 0805											
VT XNKT 08 001 KRLY	✓	X	32	3	36	60	17	M16	XNKT 0805	M4X11	T15
VT XNKT 08 002 KRLY	✓	X	40	4	36	60	17	M16			
VT XNKT 08 003 KRLY	✓	X	42	4	36	60	17	M16			

90° 4NKT 0603 TT

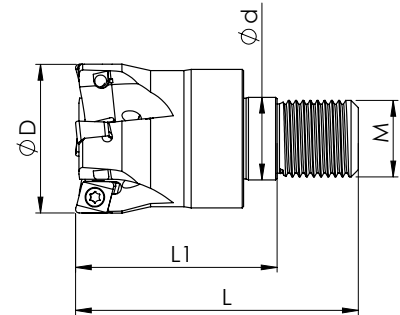

Kesici Uç Uyumluluğu Insert Suitability	Stok / Stock		Takım Ölçüleri / Dimension (mm)						Uç İnsert	Vida Screw	Anahtar Torx Key
		Inter Cooland	D	Z	L1	L	d	M			
TT 4NKT 0603											
VT 4NKT 06 002 TT	✓	✓	17	2	25	42	8,5	M8	4NKT 0603	M3X8	T10
VT 4NKT 06 004 TT	✓	✓	21	3	31	50	17	M10			
VT 4NKT 06 005 TT	✓	✓	26	3	28	50	12,5	M12			
VT 4NKT 06 006 TT	✓	✓	32	4	36	60	17	M16			

Lütfen Sipariş vermeden önce stok durumunu sorunuz.
Please ask before ordering, stock status.

L: Sol / Left

R: Sağ / Right

✓ Stokta / In Stock

X Stokta Yok / Non Stock

RD..1003/12T3/1604 ISO

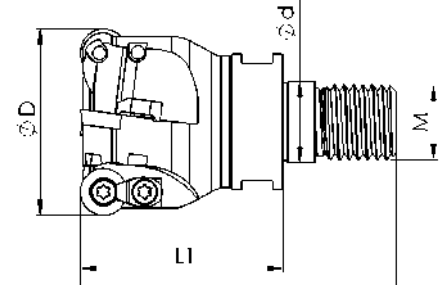

Kesici Uç Uyumluluğu Insert Suitability	Stok / Stock		Takım Ölçüleri / Dimension (mm)						Uç Insert	Vida Screw	Pabuç Clamp	Vida Screw	Anahtar Torx Key
		Inter Cooland	D	Z	L1	L	d	M					
ISO RD.. 1003/12T3/1604													
VT RD..10 001 ISO	✓	✓	25	2	29	51	12,5	M12	RD..1003	M3,5X8	CK14	M3,5X10	T15
VT RD..10 002 ISO	✓	✓	32	3	41	65	17	M16					
VT RD..10 003 ISO	✓	✓	32	4	41	65	17	M16					
VT RD..10 004 ISO	✓	✓	35	4	41	65	17	M16					
VT RD..10 005 ISO	✓	✓	40	4	44	68	17	M16					
VT RD..10 006 ISO	✓	✓	42	5	43	68	17	M16					
VT RD..10 007 ISO	✓	✓	20	2	31	50	10,5	M10	RD..12T3				
VT RD..10 008 ISO	✓	✓	30	3	41	65	17	M16					
VT RD..12 007 ISO	✓	✓	25	2	29	51	12,5	M12					
VT RD..12 008 ISO	✓	✓	32	3	41	65	17	M16					
VT RD..12 009 ISO	✓	✓	35	3	41	65	17	M16					
VT RD..12 010 ISO	✓	✓	40	4	41	65	17	M16					
VT RD..12 011 ISO	✓	✓	42	4	44	68	17	M16	RD..1604	M4,5X15		T20	
VT RD..16 012 ISO	✓	✓	32	2	41	65	17	M16					
VT RD..16 013 ISO	✓	✓	40	2	41	65	17	M16	RD..0803	M3X6			T10
VT RD..08 017 ISO	✓	✓	16	2	23	40	8,5	M8					

RPMW 1003 ISO

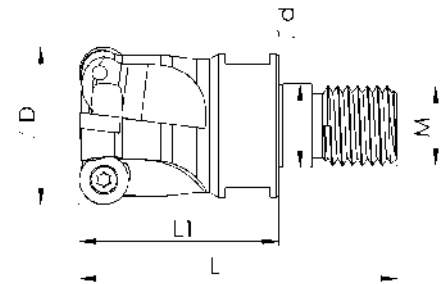

Kesici Uç Uyumluluğu Insert Suitability	Stok / Stock		Takım Ölçüleri / Dimension (mm)						Uç Insert	Vida Screw	Anahtar Torx Key
		Inter Cooland	D	Z	L1	L	d	M			
ISO RPMW 1003											
VT RPMW 10 001 ISO	✓	✓	20	2	31	50	10,5	M10	RPMW 1003	M3,5X9	T15
VT RPMW 10 002 ISO	✓	✓	25	2	29	51	12,5	M12			
VT RPMW 10 003 ISO	✓	✓	32	4	41	65	17	M16			
VT RPMW 10 004 ISO	✓	✓	42	5	44	68	17	M16			

RDHX 1003 KYCR

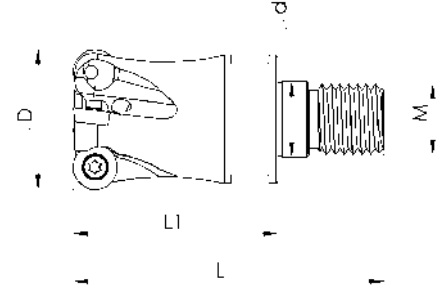

Kesici Uç Uyumluluğu Insert Suitability	Stok / Stock		Takım Ölçüleri / Dimension (mm)						Uç Insert	Vida Screw	Anahtar Torx Key
	Inter Coolant		D	Z	L1	L	d	M			
KYCR RDHX 1003											
VT RDHX 10 001 KYCR	✓	✓	32	4	46	70	17	M16	RDHX 1003	M3,5X8	T15
VT RDHX 10 002 KYCR	✓	✓	42	5	46	70	17	M16			

RPMT 12T3 KYCR

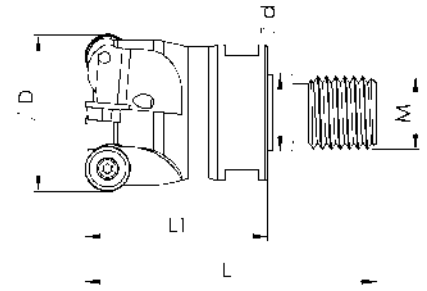

Kesici Uç Uyumluluğu Insert Suitability	Stok / Stock		Takım Ölçüleri / Dimension (mm)						Uç Insert	Vida Screw	Anahtar Torx Key
	Inter Coolant		D	Z	L1	L	d	M			
KYCR RPMT 12T3											
VT RPMT 10 001 KYCR	✓	✓	25	3	28	50	12,5	M12	RPMT 10T3	M3X8	T10
VT RPMT 10 002 KYCR	✓	✓	32	3	46	70	17	M16			
VT RPMT 10 003 KYCR	✓	✓	32	4	46	70	17	M16			
VT RPMT 10 004 KYCR	✓	✓	35	4	46	70	17	M16			
VT RPMT 10 005 KYCR	✓	✓	40	4	46	70	17	M16			
VT RPMT 10 006 KYCR	✓	✓	42	5	46	70	17	M16			

RPMT 1204 KYCR

NEW

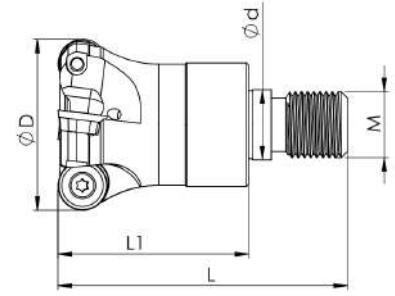

Kesici Uç Uyumluluğu Insert Suitability	Stok / Stock		Takım Ölçüleri / Dimension (mm)						Uç Insert	Vida Screw	Anahtar Torx Key
		Inter Cooland	D	Z	L1	L	d	M			
KYCR RPMT 1204											
VT RPMT 12 001 KYCR	X	✓	25	2	29	61	12,5	M12	RPMT 1204	M4X10	T15
VT RPMT 12 002 KYCR	X	✓	32	3	46	70	17	M16			
VT RPMT 12 003 KYCR	X	✓	40	4	46	70	17	M16			
VT RPMT 12 004 KYCR	X	✓	42	4	46	70	17	M16			

RDMX 1003 SNG

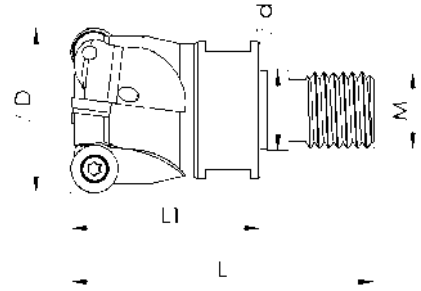

Kesici Uç Uyumluluğu Insert Suitability	Stok / Stock		Takım Ölçüleri / Dimension (mm)						Uç Insert	Vida Screw	Anahtar Torx Key
		Inter Cooland	D	Z	L1	L	d	M			
SNG RDMX 1003											
VT RDMX 10 001 SNG	✓	✓	20	2	31	50	12,5	M12	RDMX 1003	M3,5X11	T15
VT RDMX 10 002 SNG	✓	✓	25	2	29	51	12,5	M12			
VT RDMX 10 003 SNG	✓	✓	32	4	41	65	17	M16			
VT RDMX 10 004 SNG	✓	✓	35	4	41	65	17	M16			

ZOHX 2005/2506/3207 ZCC

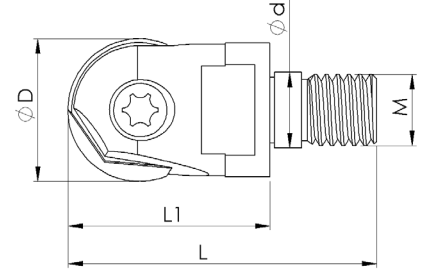

Kesici Uç Uyumluluğu Insert Suitability	Stok / Stock		Takım Ölçüleri / Dimension (mm)					Uç Insert	Vida Screw	Anahtar Torx Key
		Inter Cooland	D	L1	L	d	M			
ZCC ZOHX 2005/2506/3207										
VT ZOHX 32 001 ZCC	✓	X	32	46	70	17	M16	ZOHX 32	M8X1X25	T25
VT ZOHX 25 002 ZCC	✓	X	25	36	58	17	M12,5	ZOHX 25	M6X0,75X22	T20
VT ZOHX 20 003 ZCC	✓	X	20	31	50	17	M16	ZOHX 20	M5X0,5X17	T20

ROHX 1203/1604 ZCC

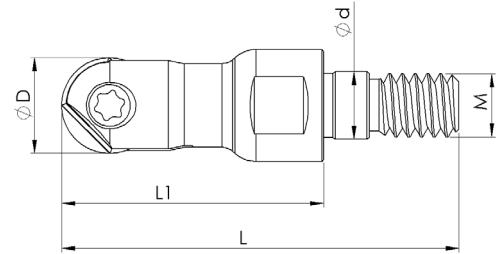

Kesici Uç Uyumluluğu Insert Suitability	Stok / Stock		Takım Ölçüleri / Dimension (mm)					Uç Insert	Vida Screw	Anahtar Torx Key
		Inter Cooland	D	L1	L	d	M			
ZCC ROHX 1203/1604										
VT ROHX 12 001 ZCC	✓	X	12	33	50	8,5	M8	ROHX 1203	M4X0,5X9	T15
VT ROHX 16 002 ZCC	✓	X	16	33	50	8,5	M8	ROHX1604	M5X0,5X14	T20
VT ROHX 20 003 ZCC	✓	X	20	42	61	10,5	M10	ROHX 2005	M5X0,5X17	T20

XPHT 32 R16 ZCC

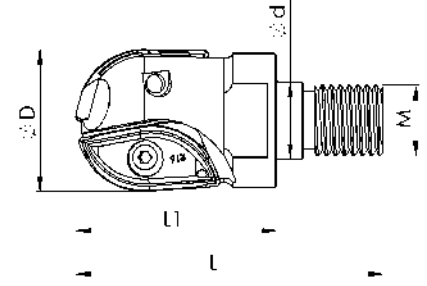

Kesici Uç Uyumluluğu Insert Suitability	Stok / Stock		Takım Ölçüleri / Dimension (mm)						Uç Insert	Vida Screw	Anahtar Torx Key
		Inter Cooland	D	Z	L1	L	d	M			
ZCC XPHT 32 R16											
VT XPHT 25 001 ZCC	✓	✓	25	2	36	58	12,5	M12	XPHT R12	M4X10	T15
VT XPHT 32 002 ZCC	✓	✓	32	2	46	70	17	M16	XPHT R16	M5X12	T20

SDMT 06T2/09T3/1204 ZCC

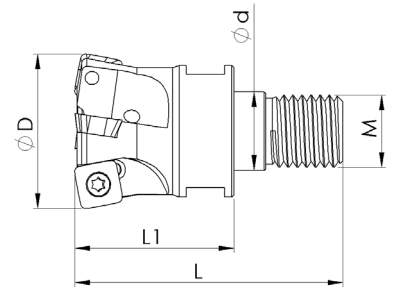

Kesici Uç Uyumluluğu Insert Suitability	Stok / Stock		Takım Ölçüleri / Dimension (mm)						Uç Insert	Vida Screw	Anahtar Torx Key
		Inter Cooland	D	Z	L1	L	d	M			
ZCC SDMT 06T2/09T3/1204											
VT SDMT 06 001 ZCC	✓	✓	16	2	26	43	8,5	M8	SDMT 0602	M3X10	T10
VT SDMT 06 002 ZCC	✓	✓	20	3	31	50	10,5	M10			
VT SDMT 06 003 ZCC	✓	✓	25	4	29	51	12,5	M12			
VT SDMT 09 003 ZCC	✓	✓	25	2	28	50	12,5	M12	SDMT 09T3	M3,5X8	T15
VT SDMT 09 004 ZCC	✓	✓	25	3	28	50	12,5	M12			
VT SDMT 09 005 ZCC	✓	✓	32	3	36	60	17	M16			
VT SDMT 09 006 ZCC	✓	✓	35	4	36	60	17	M16			
VT SDMT 09 007 ZCC	✓	✓	40	4	36	60	17	M16			
VT SDMT 09 008 ZCC	✓	✓	40	5	36	60	17	M16			
VT SDMT 09 009 ZCC	✓	✓	42	4	36	60	17	M16	SDMT 1204	M4X11	
VT SDMT 12 010 ZCC	✓	✓	42	4	36	60	17	M16			

SOEW 0803 PLBT

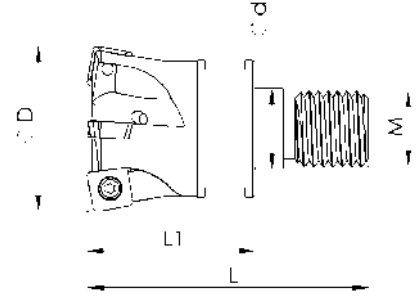

Kesici Uç Uyumluluğu Insert Suitability	Stok / Stock		Takım Ölçüleri / Dimension (mm)						Uç Insert	Vida Screw	Anahtar Torx Key
		Inter Cooland	D	Z	L1	L	d	M			
PLBT SOEW 0803											
VT SOEW 08 001 PLBT	✓	✓	32	4	36	60	17	M16	SOEW 0803	M3X8	T10
VT SOEW 08 002 PLBT	✓	✓	35	4	36	60	17	M16			
VT SOEW 08 003 PLBT	✓	✓	40	5	36	60	17	M16			
VT SOEW 08 004 PLBT	✓	✓	25	3	28	50	12,5	M12			
VT SOEW 08 005 PLBT	✓	✓	42	5	36	60	17	M16			

SDMX 09T3 PLBT

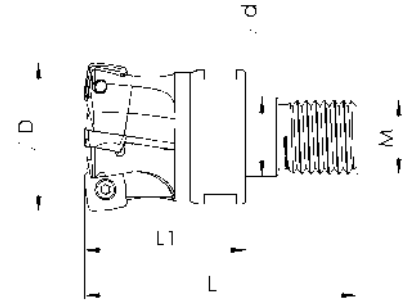

Kesici Uç Uyumluluğu Insert Suitability	Stok / Stock		Takım Ölçüleri / Dimension (mm)						Uç Insert	Vida Screw	Anahtar Torx Key
		Inter Cooland	D	Z	L1	L	d	M			
PLBT SDMX 09T312											
VT SDMX 09 001 PLBT	✓	✓	25	3	28	50	12,5	M12	SDMX 09T3	M3X10	T10
VT SDMX 09 003 PLBT	✓	✓	32	4	36	60	17	M16			
VT SDMX 09 004 PLBT	✓	✓	35	5	36	60	17	M16			
VT SDMX 09 005 PLBT	✓	✓	42	6	36	60	17	M16			
VT SDMX 09 006 PLBT	✓	✓	32	3	36	60	17	M16			

XDHW 04/06/09 PLBT

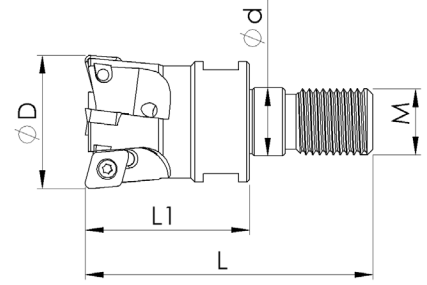

Kesici Uç Uyumluluğu Insert Suitability	Stok / Stock		Takım Ölçüleri / Dimension (mm)						Uç Insert	Vida Screw	Anahtar Torx Key
		Inter Cooland	D	Z	L1	L	d	M			
PLBT XDHW 04/06/09											
VT XDHW 04 001 PLBT	X	✓	10	2	22	40	6,5	M6	XDHW 0401	M1,8X4,2	T6
VT XDHW 04 002 PLBT	✓	✓	12	3	22	40	6,5	M6			
VT XDHW 04 003 PLBT	✓	✓	16	4	23	40	8,5	M8			
VT XDHW 06 001 PLBT	✓	✓	16	2	25	42	8,2	M8	XDHW 0602	M2,5X7	T8
VT XDHW 06 002 PLBT	✓	✓	25	3	31	53	12,5	M12			
VT XDHW 06 003 PLBT	✓	✓	32	5	35	62	17	M16			
VT XDHW 06 004 PLBT	✓	✓	35	5	35	62	17	M16			
VT XDHW 06 005 PLBT	✓	✓	20	3	31	50	10,5	M10			
VT XDHW 06 006 PLBT	✓	✓	42	6	30	62	17	M16			
VT XDHW 06 007 PLBT	✓	✓	25	4	30	52	12,5	M12			
VT XDHW 06 008 PLBT	✓	✓	17	2	25	42	8,5	M8			
VT XDHW 06 009 PLBT	✓	✓	21	3	30	52	10,5	M10			
VT XDHW 09 001 PLBT	✓	✓	25	2	28	50	12,5	M12	XDHW 09T3	M4X10	T15
VT XDHW 09 002 PLBT	✓	✓	32	3	35	60	17	M16			
VT XDHW 09 003 PLBT	✓	✓	42	4	42	65	17	M16			

SP.. 08T3 PLBT

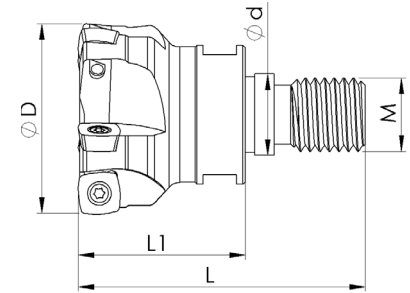

Kesici Uç Uyumluluğu Insert Suitability	Stok / Stock		Takım Ölçüleri / Dimension (mm)						Uç Insert	Vida Screw	Anahtar Torx Key
		Inter Cooland	D	Z	L1	L	d	M			
PLBT SP.. 08T3											
VT SP.. 08 001 PLBT	✓	✓	25	3	28	50	12,5	M12	SP..08T3	M3X10	T10
VT SP.. 08 002 PLBT	✓	✓	32	3	35	60	17	M16			
VT SP.. 08 003 PLBT	✓	✓	42	5	35	60	17	M16			

SEMT 09T307 PLBT

NEW

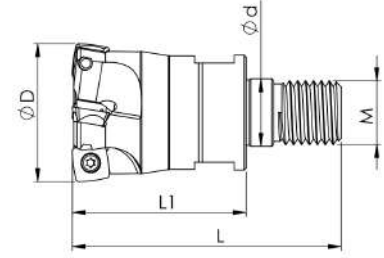

Kesici Uç Uyumluluğu Insert Suitability	Stok / Stock		Takım Ölçüleri / Dimension (mm)						Uç Insert	Vida Screw	Anahtar Torx Key
		Inter Cooland	D	Z	L1	L	d	M			
PLBT SEMT 09T307											
VT SEMT 09 002 PLBT	X	✓	35	4	44	68	17	M16	SEMT 09T3	M3X8	T10
VT SEMT 09 003 PLBT	X	✓	42	5	44	68	17	M16			

XCNT 09T3 LMT FT

NEW

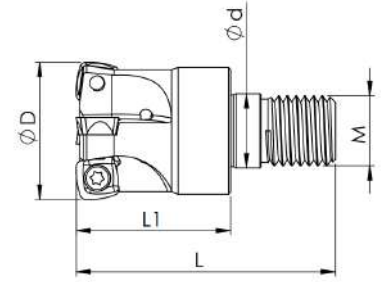

Kesici Uç Uyumluluğu Insert Suitability	Stok / Stock		Takım Ölçüleri / Dimension (mm)						Uç Insert	Vida Screw	Anahtar Torx Key
		Inter Cooland	D	Z	L1	L	d	M			
LMT XCNT 09T3											
VT XCNT 09T3 002 LMT	X	✓	32	4	36	60	17	M16	XCNT 09T3	M3,5X8	T15
VT XCNT 09T3 003 LMT	X	✓	42	4	36	60	17	M16			

WNMX 09T3 KRLY

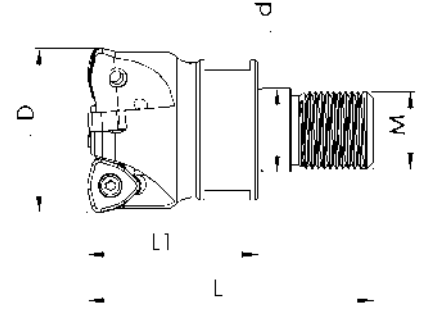

Kesici Uç Uyumluluğu Insert Suitability	Stok / Stock		Takım Ölçüleri / Dimension (mm)						Uç Insert	Vida Screw	Anahtar Torx Key
		Inter Cooland	D	Z	L1	L	d	M			
KRLY WNMX 09T316											
VT WNMX 09 001 KRLY	✓	✓	25	2	28	50	12,5	M12	WNMX 09T3	M3X10	T10
VT WNMX 09 002 KRLY	✓	✓	32	3	36	60	17	M16			
VT WNMX 09 003 KRLY	✓	✓	35	3	36	60	17	M16			
VT WNMX 09 004 KRLY	✓	✓	35	4	36	60	17	M16			
VT WNMX 09 005 KRLY	✓	✓	40	4	36	60	17	M16			
VT WNMX 09 006 KRLY	✓	✓	42	4	36	60	17	M16			

WNMX 0603 KRLY

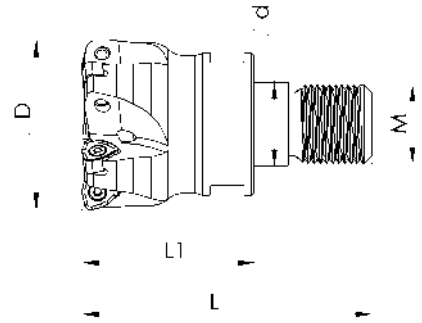

Kesici Uç Uyumluluğu Insert Suitability	Stok / Stock		Takım Ölçüleri / Dimension (mm)						Uç Insert	Vida Screw	Anahtar Torx Key
		Inter Cooland	D	Z	L1	L	d	M			
KRLY WNMX 0603											
VT WNMX 06 001 KRLY	✓	✓	16	2	25	42	8,5	M8	WNMX 0603	M2,5X8	T08
VT WNMX 06 002 KRLY	✓	✓	20	3	31	50	10,5	M10			
VT WNMX 06 003 KRLY	✓	✓	25	3	38	60	12,5	M12			
VT WNMX 06 004 KRLY	✓	✓	25	4	38	60	12,5	M12			
VT WNMX 06 005 KRLY	✓	✓	35	5	36	60	17	M16			
VT WNMX 06 006 KRLY	✓	✓	32	5	36	60	17	M16			

LNMT 0603 KRLY

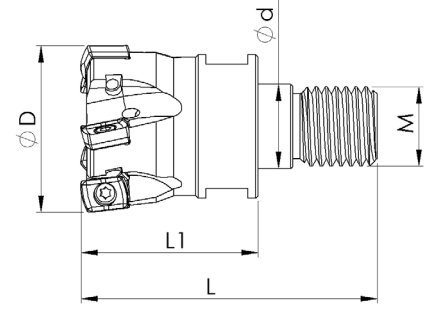

Kesici Uç Uyumluluğu Insert Suitability	Stok / Stock		Takım Ölçüleri / Dimension (mm)						Uç Insert	Vida Screw	Anahtar Torx Key
		Inter Cooland	D	Z	L1	L	d	M			
KRLY LNMT 060310											
VT LNMT 06 001 KRLY	✓	✓	25	3	28	50	12,5	M12	LNMT 0603	M3X8	T10
VT LNMT 06 002 KRLY	✓	✓	35	5	36	60	17	M16			
VT LNMT 06 003 KRLY	✓	✓	40	6	36	60	17	M16			

LNMX 060310 KRLY

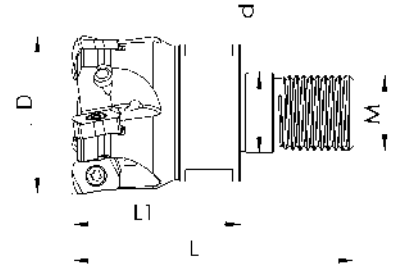

Kesici Uç Uyumluluğu Insert Suitability	Stok / Stock		Takım Ölçüleri / Dimension (mm)						Uç Insert	Vida Screw	Anahtar Torx Key
		Inter Cooland	D	Z	L1	L	d	M			
KRLY LNMX 060310											
VT LNMX 06 001 KRLY	✓	✓	16	2	23	40	8,5	M8	LNMX 060310	M3X8	T10
VT LNMX 06 002 KRLY	✓	✓	20	3	31	50	10,5	M10			
VT LNMX 06 003 KRLY	✓	✓	25	4	28	50	12,5	M12			
VT LNMX 06 004 KRLY	✓	✓	32	5	36	60	17	M16			
VT LNMX 06 005 KRLY	✓	✓	42	6	36	60	17	M16			
VT LNMX 06 006 KRLY	✓	✓	32	5	36	60	17	M16			
VT LNMX 06 007 KRLY	✓	✓	40	6	36	60	17	M16			
VT LNMX 06 008 KRLY	✓	✓	17	5	23	40	8,5	M8			
VT LNMX 06 009 KRLY	✓	✓	21	3	31	50	10,5	M12			
VT LNMX 06 010 KRLY	✓	✓	26	4	28	50	12,5	M12			

BLM. 0603 TT

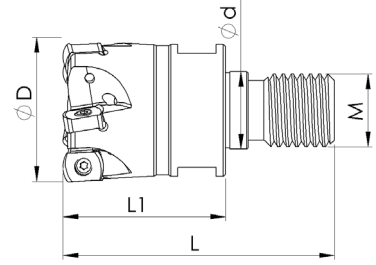

Kesici Uç Uyumluluğu Insert Suitability	Stok / Stock		Takım Ölçüleri / Dimension (mm)						Uç Insert	Vida Screw	Anahtar Torx Key
	TT	Inter Cooland	D	Z	L1	L	d	M			
TT BLM. 0603											
VT BLM 06 001 TT	✓	✓	32	5	36	60	17	M16	BLM 0603	M2,5X7	T08
VT BLM 06 002 TT	✓	✓	42	6	36	60	17	M16			
VT BLM 06 003 TT	✓	✓	20	3	31	50	10,5	M10			
VT BLM 06 004 TT	✓	✓	25	4	38	60	12,5	M12			
VT BLM 06 005 TT	✓	✓	40	6	36	60	17	M16			



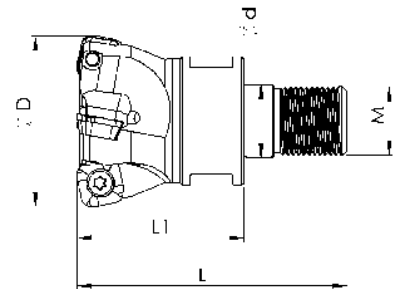



SOMT 1004/1404 KYCR

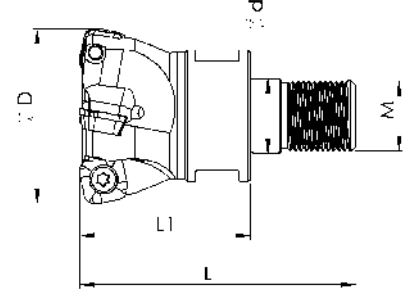

Kesici Uç Uyumluluğu Insert Suitability	Stok / Stock		Takım Ölçüleri / Dimension (mm)						Uç Insert	Vida Screw	Anahtar Torx Key
	KYCR	Inter Cooland	D	Z	L1	L	d	M			
KYCR SOMT 1004/1404											
VT SOMT 10 001 KYCR	✓	✓	32	3	40	64	17	M16	SOMT 1004	M4X10	T15
VT SOMT 10 002 KYCR	✓	✓	35	3	40	64	17	M16			
VT SOMT 10 003 KYCR	✓	✓	40	4	40	64	17	M16			
VT SOMT 10 004 KYCR	✓	✓	42	4	40	64	17	M16			
VT SOMT 14 005 KYCR	✓	✓	42	3	40	64	17	M16	SOMT 1404	M5X12	T20

LOGU 0303 KYCR



Kesici Uç Uyumluluğu Insert Suitability	Stok / Stock		Takım Ölçüleri / Dimension (mm)						Uç Insert	Vida Screw	Anahtar Torx Key
		Inter Coolant	D	Z	L1	L	d	M			
KYCR LOGU 0303											
VT LOGU 03 001 KYCR	✓	✓	20	3	31	50	10,5	M10	LOGU 0303	M3X8 LOGU	T08
VT LOGU 03 002 KYCR	✓	✓	25	4	29	51	12,5	M12			
VT LOGU 03 003 KYCR	✓	✓	32	5	39	63	17	M16			
VT LOGU 03 004 KYCR	✓	✓	40	6	39	63	17	M16			
VT LOGU 03 005 KYCR	✓	✓	42	6	39	63	17	M16			
VT LOGU 03 006 KYCR	✓	✓	35	5	39	63	17	M16			
VT LOGU 03 007 KYCR	✓	✓	17	2	33	50	8,5	M8			

P26335 R10/R14 WLTR

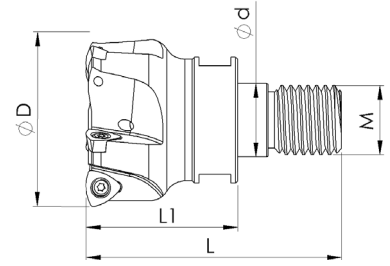

Kesici Uç Uyumluluğu Insert Suitability	Stok / Stock		Takım Ölçüleri / Dimension (mm)						Uç Insert	Vida Screw	Anahtar Torx Key
		Inter Cooland	D	Z	L1	L	d	M			
WLTR P26335 R10/R14											
VT P2633 R14 002 WLTR	✓	✓	40	5	36	60	17	M16	P26..R-16	M2,5X7	T8
VT P2633 R10 004 WLTR	✗	✓	32	3	36	60	17	M16	R26..R-14	M4X11	T15

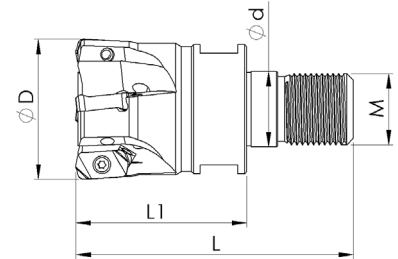

LNMU 0303 TNG



Kesici Uç Uyumluluğu Insert Suitability	Stok / Stock		Takım Ölçüleri / Dimension (mm)						Uç Insert	Vida Screw	Anahtar Torx Key
		Inter Cooland	D	Z	L1	L	d	M			
TNGLY LNMU 0303											
VT LNMU 03 001 TNG	✓	✓	25	4	29	51	12,5	M12	LNMU 0303	M2,5X7	T8
VT LNMU 03 002 TNG	✓	✓	32	5	39	63	17	M16			
VT LNMU 03 004 TNG	✓	✓	40	6	39	63	17	M16			
VT LNMU 03 005 TNG	✓	✓	20	3	31	50	10,5	M10			
VT LNMU 03 006 TNG	✓	✓	32	4	39	63	17	M16			
VT LNMU 03 007 TNG	✓	✓	35	4	39	63	17	M16			
VT LNMU 03 008 TNG	✓	✓	42	5	39	63	17	M16			
VT LNMU 03 009 TNG	✓	✓	42	6	39	63	17	M16			

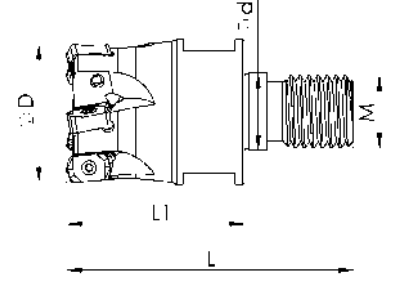

BNGX 10T3 PRMT

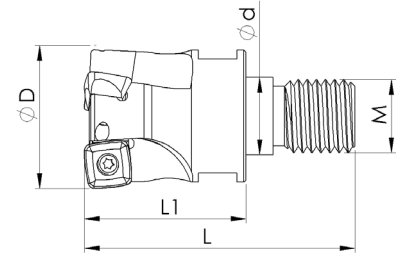

Kesici Uç Uyumluluğu Insert Suitability	Stok / Stock		Takım Ölçüleri / Dimension (mm)						Uç Insert	Vida Screw	Anahtar Torx Key
		Inter Cooland	D	Z	L1	L	d	M			
PRMT BNGX 10T3											
VT BNGX 10 001 PRMT	X	✓	25	4	28	50	12,5	M12	BNGX 10T3	M2,5X7	T8
VT BNGX 10 002 PRMT	X	✓	32	5	38	62	17	M16			

SDMT 1004 BHLR



Kesici Uç Uyumluluğu Insert Suitability	Stok / Stock		Takım Ölçüleri / Dimension (mm)						Uç Insert	Vida Screw	Anahtar Torx Key
		Inter Cooland	D	Z	L1	L	d	M			
BHLR SDMT 1004											
VT SDMT 10 001 BHLR	✓	✓	32	3	34	60	17	M16	SDMT 1004	M3X8	T8
VT SDMT 10 002 BHLR	✓	✓	25	2	28	50	12,5	M12			

SPMW 1204 SNG

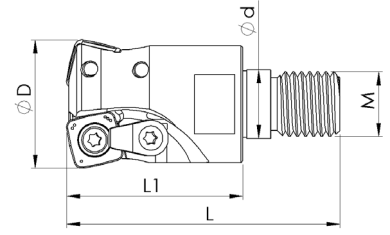

Kesici Uç Uyumluluğu Insert Suitability	Stok / Stock		Takım Ölçüleri / Dimension (mm)					Uç İnsert	Pabuç Clamp	Vida Screw	Anahtar Torx Key	
		Inter Cooland	D	Z	L1	L	d	M				
SNG SPMW 1204												
VT SPMW 12 001 SNG	✓	✓	32	2	44	68	17	M16	SPMW 1204	CK15	M4X11	T15
VT SPMW 12 002 SNG	✓	✓	40	3	44	68	17	M16				

SOMW 080315 SNG

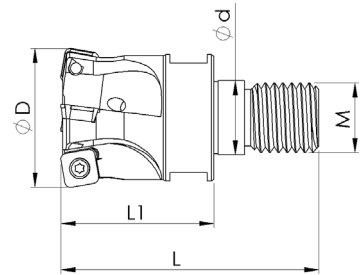

Kesici Uç Uyumluluğu Insert Suitability	Stok / Stock		Takım Ölçüleri / Dimension (mm)					Uç İnsert	Vida Screw	Anahtar Torx Key	
		Inter Cooland	D	Z	L1	L	d	M			
SNG SOMW 080315											
VT SOMW 08 001 SNG	✓	✓	20	2	31	50	10,5	M10	SOMW 080315	M3X8	T10
VT SOMW 08 002 SNG	✓	✓	25	3	29	51	12,5	M12			
VT SOMW 08 003 SNG	✓	✓	32	4	36	60	17	M16			
VT SOMW 08 004 SNG	✓	✓	42	5	36	60	17	M16			
VT SOMW 08 005 SNG	✓	✓	40	5	36	60	17	M16			

EPGX 0602 SNG

NEW

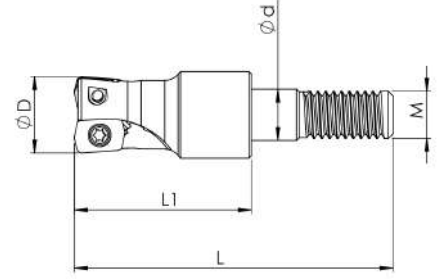

Kesici Uç Uyumluluğu
Insert Suitability

Stok / Stock

Takım Ölçüleri / Dimension (mm)

Uç
Insert

Vida
Screw

Anahtar
Torx Key

SNG
EPGX 0602

VT EPGX 06 001 SNG

VT EPGX 06 002 SNG

X

X

✓

✓

10

12

2

2

22

22

40

40

6,5

6,5

M6

M6



EPGX 0602

M1,8X4,2

T6

XDHX 06/10 SNG

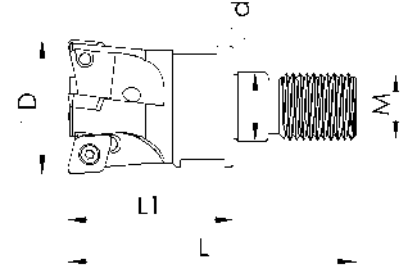

Kesici Uç Uyumluluğu
Insert Suitability

Stok / Stock

Takım Ölçüleri / Dimension (mm)

Uç
Insert

Vida
Screw

Anahtar
Torx Key

SNG
XDHX 06/10

VT XDHX 06 001 SNG

VT XDHX 06 002 SNG

VT XDHX 10 003 SNG

VT XDHX 10 004 SNG

✓

✓

✓

✓

✓

✓

✓

✓

20

25

32

35

3

4

3

3

31

31

36

36

50

53

60

60

10,5

12,5

17

17

M10

M12

M16

M16



XDHX 06

M2,5X7

T6

XDHX 10

M4X10

T15

YNGX 0603 SNG

NEW

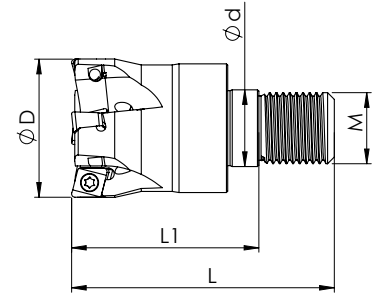

Kesici Uç Uyumluluğu
Insert Suitability

Stok / Stock

Takım Ölçüleri / Dimension (mm)

Uç
Insert

Vida
Screw

Anahtar
Torx Key

SNG
YNGX 0603

VT YNGX 06 001 SNG

VT YNGX 06 002 SNG

VT YNGX 06 003 SNG

VT YNGX 06 004 SNG

VT YNGX 06 005 SNG

✓

✓

✓

✓

✓

✓

✓

✓

✓

✓

16

20

25

32

40

2

3

3

4

5

24

31

29

36

36

41

50

51

60

60

8,5

10,5

12,5

17

17

M8

M10

M12

M16

M16



YNGX 0603

M3X8

T10



U - DRILLER U - DRILLS

DRILL WCM. D2

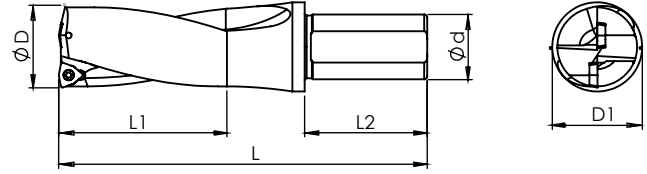

Kesici Uç Uyumluluğu Insert Suitability	Stok / Stock		Takım Ölçüleri / Dimension (mm)						Uç Insert	Vida Screw	Anahtar Torx Key
	WCM	Inter Coolant	D	d	d1	L	L1	L2			
WCM D2 016 ISO	✓	✓	16	25	34	110	32	50	WCM 030208	M2,5X6	T08
WCM D2 016,5 ISO	✓	✓	16,5	25	34	112	33	56			
WCM D2 017 ISO	✓	✓	17	25	34	112	34	56			
WCM D2 017,5 ISO	✓	✓	17,5	25	34	114	35	56			
WCM D2 018 ISO	✓	✓	18	25	34	114	36	56			
WCM D2 018,5 ISO	✓	✓	18,5	25	34	116	37	56			
WCM D2 019 ISO	✓	✓	19	25	34	116	38	56			
WCM D2 019,5 ISO	✓	✓	19,5	25	34	119	39	56			
WCM D2 020 ISO	✓	✓	20	25	34	119	40	56			
WCM D2 020,5 ISO	✓	✓	20,5	25	34	122	41	56			
WCM D2 021 ISO	✓	✓	21	25	34	122	42	56			
WCM D2 021,5 ISO	✓	✓	21	25	34	125	43	56			
WCM D2 022 ISO	✓	✓	22	25	34	125	44	56			
WCM D2 022,5 ISO	✓	✓	22,5	25	34	128	45	56			
WCM D2 023 ISO	✓	✓	23	25	34	128	46	56			
WCM D2 023,5 ISO	✓	✓	23,5	25	34	129	47	56			
WCM D2 024 ISO	✓	✓	24	25	34	129	48	56			
WCM D2 024,5 ISO	✓	✓	24,5	25	34	131	49	56			
WCM D2 025 ISO	✓	✓	25	25	34	131	50	56			
WCM D2 025,5 ISO	✓	✓	25,5	25	34	134	53	56			
WCM D2 026 ISO	✓	✓	26	25	34	134	52	56			
WCM D2 026,5 ISO	✓	✓	26,5	25	34	137	53	56			
WCM D2 027 ISO	✓	✓	27	25	34	137	54	56			
WCM D2 027,5 ISO	✓	✓	27,5	25	34	140	55	56			
WCM D2 028 ISO	✓	✓	28	25	34	140	56	56			
WCM D2 028,5 ISO	✓	✓	28,5	25	34	140	57	56			
WCM D2 029 ISO	✓	✓	29	25	34	143	58	56			
WCM D2 029,5 ISO	✓	✓	28,5	25	34	143	59	60			
WCM D2 030 ISO	✓	✓	30	32	44	150	60	60			
WCM D2 031 ISO	✓	✓	31	32	44	153	62	60			
WCM D2 032 ISO	✓	✓	32	32	44	156	64	60			
WCM D2 033 ISO	✓	✓	33	32	44	159	66	60			
WCM D2 034 ISO	✓	✓	34	32	44	162	68	60			
WCM D2 035 ISO	✓	✓	35	32	44	165	70	60			
WCM D2 036 ISO	✓	✓	36	32	44	168	72	60			
WCM D2 037 ISO	✓	✓	37	32	44	171	74	60			
WCM D2 038 ISO	✓	✓	38	32	44	174	76	60			
WCM D2 039 ISO	✓	✓	39	32	44	177	78	60			
WCM D2 040 ISO	✓	✓	40	32	44	180	80	60			
WCM D2 041 ISO	✓	✓	41	32	44	183	82	60			
WCM D2 042 ISO	✓	✓	42	32	44	186	84	60			
WCM D2 043 ISO	✓	✓	43	32	44	189	86	60			
WCM D2 044 ISO	✓	✓	44	32	44	192	88	60			
WCM D2 045 ISO	✓	✓	45	40	54	195	90	70			
WCM D2 046 ISO	✓	✓	46	40	54	198	92	70			
WCM D2 047 ISO	✓	✓	47	40	54	201	94	70			
WCM D2 048 ISO	✓	✓	48	40	54	204	96	70			
WCM D2 049 ISO	✓	✓	49	40	54	207	98	70			
WCM D2 050 ISO	✓	✓	50	40	54	210	100	70			
									WCM 040208	M2,5X7	T08
									WCM 050308	M3X9	T10
									WCM 06T308	M3,5X9	T15
									WCM 080412	M4X11	T15

Takma uçlu matkaplarda ±0,20 mm ölçü toleransı vardır / U-drill have a diameter tolerance between ±0,20 mm

Lütfen Sipariş vermeden önce stok durumunu sorunuz.
Please ask before ordering, stock status.

L: Sol / Left

R: Sağ / Right

✓ Stokta / In Stock

✗ Stokta Yok / Non Stock

DRILL WCM. D3

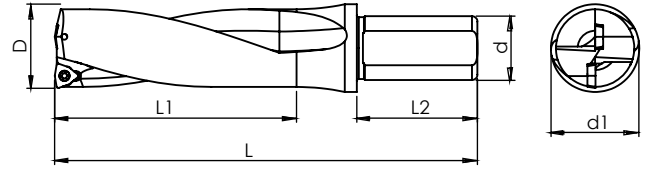

Kesici Uç Uyumluluğu Insert Suitability	Stok / Stock		Takım Ölçüleri / Dimension (mm)						Uç Insert	Vida Screw	Anahtar Torx Key
	WCM	Inter Coolant	D	d	d1	L	L1	L2			
WCM.D3 015,5 ISO	✓	✓	15,5	25	34	126	46,5	56	WCM 030208	M2,5X6	T08
WCM.D3 016 ISO	✓	✓	16	25	34	126	48	56			
WCM.D3 016,5 ISO	✓	✓	16,5	25	34	129	49,5	56			
WCM.D3 017 ISO	✓	✓	17	25	34	129	51	56			
WCM.D3 017,5 ISO	✓	✓	17,5	25	34	132	52,5	56			
WCM.D3 018 ISO	✓	✓	18	25	34	132	54	56			
WCM.D3 018,5 ISO	✓	✓	18,5	25	34	135	55,5	56			
WCM.D3 019 ISO	✓	✓	19	25	34	135	57	56			
WCM.D3 019,5 ISO	✓	✓	19,5	25	34	139	58,5	56			
WCM.D3 020 ISO	✓	✓	20	25	34	139	60	56			
WCM.D3 020,5 ISO	✓	✓	20,5	25	34	143	61,5	56	WCM 040208	M2,5X7	T08
WCM.D3 021 ISO	✓	✓	21	25	34	143	63	56			
WCM.D3 021,5 ISO	✓	✓	21,5	25	34	147	64,5	56			
WCM.D3 022 ISO	✓	✓	22	25	34	147	66	56			
WCM.D3 022,5 ISO	✓	✓	22,5	25	34	151	67,5	56			
WCM.D3 023 ISO	✓	✓	23	25	34	151	69	56			
WCM.D3 023,5 ISO	✓	✓	23,5	25	34	153	70,5	56			
WCM.D3 024 ISO	✓	✓	24	25	34	153	72	56			
WCM.D3 024,5 ISO	✓	✓	24,5	25	34	156	73,5	56			
WCM.D3 025 ISO	✓	✓	25	25	34	156	75	56			
WCM.D3 025,5 ISO	✓	✓	25,5	25	34	160	76,5	56			
WCM.D3 026 ISO	✓	✓	26	25	34	160	78	56			
WCM.D3 026,5 ISO	✓	✓	26,5	25	34	164	79,5	56			
WCM.D3 027 ISO	✓	✓	27	25	34	164	81	56			
WCM.D3 027,5 ISO	✓	✓	27,5	25	34	168	82,5	56			
WCM.D3 028 ISO	✓	✓	28	25	34	168	84	56			
WCM.D3 028,5 ISO	✓	✓	28,5	25	34	172	85,5	56			
WCM.D3 029 ISO	✓	✓	29	25	34	172	87	56			
WCM.D3 029,5 ISO	✓	✓	29,5	25	34	172	88,5	56	WCM 06T308	M3,5X9	T15
WCM.D3 030 ISO	✓	✓	30	32	44	180	90	60			
WCM.D3 030,5 ISO	✓	✓	30,5	32	44	184	91,5	60			
WCM.D3 031 ISO	✓	✓	31	32	44	184	93	60			
WCM.D3 031,5 ISO	✓	✓	31,5	32	44	188	94,5	60			
WCM.D3 032 ISO	✓	✓	32	32	44	188	96	60			
WCM.D3 032,5 ISO	✓	✓	32,5	32	44	192	97,5	60			
WCM.D3 033 ISO	✓	✓	33	32	44	192	99	60			
WCM.D3 033,5 ISO	✓	✓	33,5	32	44	192	100,5	60			
WCM.D3 034 ISO	✓	✓	34	32	44	192	102	60			
WCM.D3 034,5 ISO	✓	✓	34,5	32	44	200	103,5	60			
WCM.D3 035 ISO	✓	✓	35	32	44	200	105	60			
WCM.D3 035,5 ISO	✓	✓	35,5	32	44	204	106,5	60			
WCM.D3 036 ISO	✓	✓	36	32	44	204	108	60			
WCM.D3 036,5 ISO	✓	✓	36,5	32	44	208	109,5	60			
WCM.D3 037 ISO	✓	✓	37	32	44	208	111	60			
WCM.D3 037,5 ISO	✓	✓	37,5	32	44	212	112,5	60			
WCM.D3 038 ISO	✓	✓	38	32	44	212	114	60			
WCM.D3 038,5 ISO	✓	✓	38,5	32	44	216	115,5	60			
WCM.D3 039 ISO	✓	✓	39	32	44	216	117	60			
WCM.D3 039,5 ISO	✓	✓	39,5	32	44	220	118,5	60			
WCM.D3 040 ISO	✓	✓	40	32	44	220	120	60			

Takma uçlu matkaplarda ±0,20 mm ölçü toleransı vardır / U-drill have a diameter tolerance between ±0,20 mm

L: Sol / Left

R: Sağ / Right

✓ Stokta / In Stock

✗ Stokta Yok / Non Stock

Lütfen Sipariş vermeden önce stok durumunu sorunuz.
Please ask before ordering, stock status.

DRILL WCM. D3

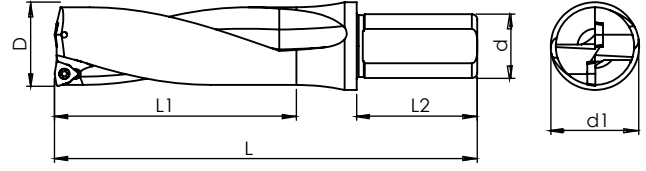

Kesici Uç Uyumluluğu Insert Suitability	Stok / Stock		Takım Ölçüleri / Dimension (mm)						Uç İnsert	Vida Screw	Anahtar Torx Key
	✓	Inter Cooland	D	d	d1	L	L1	L2			
WCM											
WCM.D3 041 ISO	✓	✓	41	32	44	223	123	60	WCM 06T308	M3,5X9	T15
WCM.D3 042 ISO	✓	✓	42	32	44	226	126	60			
WCM.D3 043 ISO	✓	✓	43	32	44	229	129	60			
WCM.D3 044 ISO	✓	✓	44	32	44	232	132	60	WCM 080412	M4X11	T15
WCM.D3 045 ISO	✓	✓	45	40	54	245	135	70			
WCM.D3 046 ISO	✓	✓	46	40	54	248	138	70			
WCM.D3 047 ISO	✓	✓	47	40	54	251	141	70			
WCM.D3 048 ISO	✓	✓	48	40	54	254	144	70			
WCM.D3 049 ISO	✓	✓	49	40	54	257	147	70			
WCM.D3 050 ISO	✓	✓	50	40	54	260	150	70			

Takma uçlu matkaplarda $\pm 0,20$ mm ölçü toleransı vardır / U-drill have a diameter tolerance between $\pm 0,20$ mm

Lütfen Sipariş vermeden önce stok durumunu sorunuz.
Please ask before ordering, stock status.

L: Sol / Left

R: Sağ / Right

✓ Stokta / In Stock

✗ Stokta Yok / Non Stock

DRILL WCM. D4

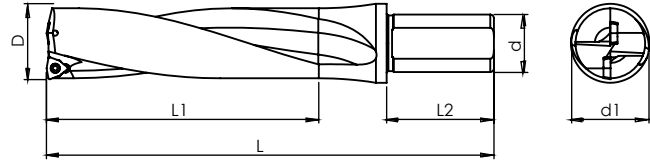

Kesici Uç Uyumluluğu Insert Suitability	Stok / Stock		Takım Ölçüleri / Dimension (mm)						Uç Insert	Vida Screw	Anahtar Torx Key
	WCM	Inter Cooland	D	d	d1	L	L1	L2			
WCM.D4 015,5 ISO	✓	✓	15,5	25	34	142	62	56	WCM.030208	M2,5X6	T08
WCM.D4 016 ISO	✓	✓	16	25	34	142	64	56			
WCM.D4 017 ISO	✓	✓	17	25	34	146	68	56			
WCM.D4 017,5 ISO	✓	✓	17,5	25	34	150	72	56			
WCM.D4 018 ISO	✓	✓	18	25	34	150	72	56			
WCM.D4 019 ISO	✓	✓	19	25	34	154	76	56			
WCM.D4 019,5 ISO	✓	✓	19,5	25	34	159	80	56	WCM.040208	M2,5X7	
WCM.D4 020 ISO	✓	✓	20	25	34	159	80	56			
WCM.D4 021 ISO	✓	✓	21	25	34	164	84	56			
WCM.D4 022 ISO	✓	✓	22	25	34	169	88	56			
WCM.D4 023 ISO	✓	✓	23	25	34	174	92	56			
WCM.D4 023,5 ISO	✓	✓	23,5	25	34	174	94	56			
WCM.D4 024 ISO	✓	✓	24	25	34	177	96	56	WCM 050308	M3X9	T10
WCM.D4 025 ISO	✓	✓	25	25	34	181	100	56			
WCM.D4 025,5 ISO	✓	✓	25,5	25	34	181	102	56			
WCM.D4 026 ISO	✓	✓	26	25	34	186	104	56			
WCM.D4 027 ISO	✓	✓	27	25	34	191	108	56			
WCM.D4 027,5 ISO	✓	✓	27,5	25	34	225	110	56			
WCM.D4 028 ISO	✓	✓	28	25	34	196	112	56	WCM 06T308	M3,5X9	T15
WCM.D4 029 ISO	✓	✓	29	25	34	201	116	56			
WCM.D4 030 ISO	✓	✓	30	32	44	210	120	60			
WCM.D4 031 ISO	✓	✓	31	32	44	215	124	60			
WCM.D4 031,5 ISO	✓	✓	31,5	32	44	220	126	60			
WCM.D4 032 ISO	✓	✓	32	32	44	220	128	60			
WCM.D4 033 ISO	✓	✓	33	32	44	225	132	60	WCM 080412	M4X11	
WCM.D4 033,5 ISO	✓	✓	33,5	32	44	225	134	60			
WCM.D4 034 ISO	✓	✓	34	32	44	230	136	60			
WCM.D4 035 ISO	✓	✓	35	32	44	235	140	60			
WCM.D4 036 ISO	✓	✓	36	32	44	238	144	60			
WCM.D4 037 ISO	✓	✓	37	32	44	241	148	60			
WCM.D4 038 ISO	✓	✓	38	32	44	244	152	60	WCM 080412	M4X11	
WCM.D4 038,5 ISO	✓	✓	38,5	32	44	247	164	60			
WCM.D4 039 ISO	✓	✓	39	32	44	247	166	60			
WCM.D4 040 ISO	✓	✓	40	32	44	250	160	60			
WCM.D4 041 ISO	✓	✓	41	32	44	253	164	60			
WCM.D4 041,5 ISO	✓	✓	41,5	32	44	256	166	60			
WCM.D4 042 ISO	✓	✓	42	32	44	256	168	60	WCM 080412	M4X11	
WCM.D4 043 ISO	✓	✓	43	32	44	259	172	60			
WCM.D4 044 ISO	✓	✓	44	32	44	262	176	60			
WCM.D4 044 ISO	✓	✓	44	32	44	262	176	60			
WCM.D4 045 ISO	✗	✓	45	40	54	265	180	70			
WCM.D4 046 ISO	✗	✓	46	40	54	268	184	70			
WCM.D4 047 ISO	✗	✓	47	40	54	271	188	70	WCM 080412	M4X11	
WCM.D4 048 ISO	✗	✓	48	40	54	274	192	70			
WCM.D4 049 ISO	✗	✓	49	40	54	277	196	70			
WCM.D4 050 ISO	✗	✓	50	40	54	280	200	70			

DRILL WCM. D5

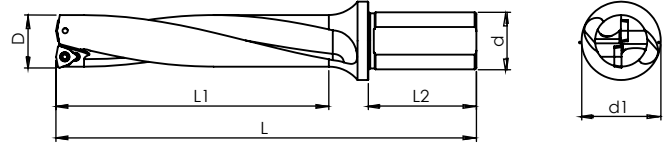

Kesici Uç Uyumluluğu Insert Suitability	Stok / Stock		Takım Ölçüleri / Dimension (mm)						Uç İnsert	Vida Screw	Anahtar Torx Key
	WCM	Inter Cooland	D	d	d1	L	L1	L2			
WCM.D5 016 ISO	✓	✓	16	25	34	153	80	56	WCM.030208	M2,5X6	T08
WCM.D5 017 ISO	✓	✓	17	25	34	158	85	56			
WCM.D5 018 ISO	✓	✓	18	25	34	163	90	56			
WCM.D5 019 ISO	✓	✓	19	25	34	168	95	56			
WCM.D5 020 ISO	✓	✓	20	25	34	174	100	56	WCM.040208	M2,5X7	T08
WCM.D5 021 ISO	✓	✓	21	25	34	180	105	56			
WCM.D5 022 ISO	✓	✓	22	25	34	186	110	56			
WCM.D5 023 ISO	✓	✓	23	25	34	192	115	56			
WCM.D5 024 ISO	✓	✓	24	25	34	196	120	56	WCM.050308	M3x9	T10
WCM.D5 025 ISO	✓	✓	25	25	34	200	125	56			
WCM.D5 026 ISO	✓	✓	26	25	34	206	130	56			
WCM.D5 027 ISO	✓	✓	27	25	34	212	135	56			
WCM.D5 028 ISO	✓	✓	28	25	34	218	140	56	WCM.06T308	M3,5X9	T15
WCM.D5 029 ISO	✓	✓	29	25	34	224	145	56			
WCM.D5 030 ISO	✓	✓	30	32	44	233	150	60			

DRILL SP.. D2

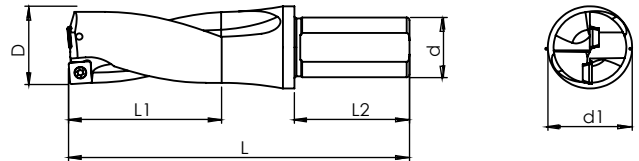

Kesici Uç Uyumluluğu Insert Suitability	Stok / Stock		Takım Ölçüleri / Dimension (mm)						Uç İnsert	Vida Screw	Anahtar Torx Key
	TGTC / PLBT / ZCC / KLP	Inter Cooland	D	d	d1	L	L1	L2			
SP..D2 012,5 ISO	✓	✓	12,5	20	25	94	25	50	SP..050204	M2X5	T06
SP..D2 013 ISO	✓	✓	13	20	25	94	26	50			
SP..D2 013,5 ISO	✓	✓	13,5	20	25	94	27	50			
SP..D2 014 ISO	✓	✓	14	20	25	97	28	50			
SP..D2 014,5 ISO	✓	✓	14,5	20	25	100	29	50	SP..060204	M2.2X5	T06
SP..D2 015 ISO	✓	✓	15	20	25	100	30	50			
SP..D2 015,5 ISO	✓	✓	15,5	25	34	110	31	56			
SP..D2 016 ISO	✓	✓	16	25	34	110	32	56			
SP..D2 016,5 ISO	✓	✓	16,5	25	34	112	33	56	SP..060204	M2.2X5	T06
SP..D2 017 ISO	✓	✓	17	25	34	112	34	56			
SP..D2 017,5 ISO	✓	✓	17,5	25	34	113	35	56			
SP..D2 018 ISO	✓	✓	18	25	34	114	36	56			

Takma uçlu matkaplarda $\pm 0,20$ mm ölçü toleransı vardır / U-drill have a diameter tolerance between $\pm 0,20$ mm

Lütfen Sipariş vermeden önce stok durumunu sorunuz.
Please ask before ordering, stock status.

L: Sol / Left

R: Sağ / Right

✓ Stokta / In Stock

✗ Stokta Yok / Non Stock

DRILL SP.. D2

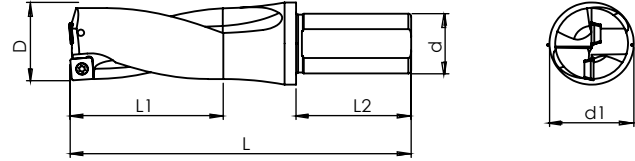

Kesici Uç Uyumluluğu Insert Suitability	Stok / Stock		Takım Ölçüleri / Dimension (mm)						Uç Insert	Vida Screw	Anahtar Torx Key
	TGTC / PLBT / ZCC / KLP	Inter Cooland	D	d	d1	L	L1	L2			
SP..D2 018,5 ISO	✓	✓	18,5	25	34	116	37	56	SP..060204	M2.2X5	T06
SP..D2 019 ISO	✓	✓	19	25	34	116	38	56			
SP..D2 019,5 ISO	✓	✓	19,5	25	34	119	39	56			
SP..D2 020 ISO	✓	✓	20	25	34	119	40	56			
SP..D2 20,5 ISO	✓	✓	20,5	25	34	122	41	56			
SP..D2 021 ISO	✓	✓	21	25	34	122	42	56			
SP..D2 021,5 ISO	✓	✓	21,5	25	34	125	43	56			
SP..D2 022 ISO	✓	✓	22	25	34	125	44	56			
SP..D2 022,5 ISO	✓	✓	22,5	25	34	128	45	56			
SP..D2 023 ISO	✓	✓	23	25	34	128	46	56			
SP..D2 023,5 ISO	✓	✓	23,5	25	34	129	47	56	SP..07T308	M2.5X7	T08
SP..D2 024 ISO	✓	✓	24	25	34	129	48	56			
SP..D2 024,5 ISO	✓	✓	24,5	25	34	131	49	56			
SP..D2 025 ISO	✓	✓	25	25	34	131	50	56			
SP..D2 025,5 ISO	✓	✓	25,5	25	34	134	51	56			
SP..D2 026 ISO	✓	✓	26	25	34	134	52	56			
SP..D2 026,5 ISO	✓	✓	26,5	25	34	136	53	56			
SP..D2 027 ISO	✓	✓	27	25	34	137	54	56			
SP..D2 027,5 ISO	✓	✓	27,5	25	34	140	55	56			
SP..D2 028 ISO	✓	✓	28	25	34	140	56	56			
SP..D2 028,5 ISO	✓	✓	28,5	25	34	143	57	56			
SP..D2 029 ISO	✓	✓	29	25	34	143	58	56			
SP..D2 029,5 ISO	✓	✓	29,5	25	34	143	59	56			
SP..D2 030 ISO	✓	✓	30	32	44	150	60	60			
SP..D2 031 ISO	✓	✓	31	32	44	153	62	60			
SP..D2 032 ISO	✓	✓	32	32	44	156	64	60			
SP..D2 033 ISO	✓	✓	33	32	44	159	66	60			
SP..D2 034 ISO	✓	✓	34	32	44	162	68	60			
SP..D2 035 ISO	✓	✓	35	32	44	165	70	60	SP..110408	M4X11	T20
SP..D2 036 ISO	✓	✓	36	32	44	168	72	60			
SP..D2 037 ISO	✓	✓	37	32	44	171	74	60			
SP..D2 038 ISO	✓	✓	38	32	44	174	76	60			
SP..D2 039 ISO	✓	✓	39	32	44	177	78	60			
SP..D2 040 ISO	✓	✓	40	32	44	180	80	60			
SP..D2 041 ISO	✓	✓	41	32	44	183	82	60			
SP..D2 042 ISO	✓	✓	42	32	44	186	84	60			
SP..D2 42,5 ISO	✓	✓	42,5	32	44	189	86	60			
SP..D2 043 ISO	✓	✓	43	32	44	189	86	60			
SP..D2 044 ISO	✓	✓	44	32	44	192	88	60			
SP..D2 045 ISO	✓	✓	45	40	54	195	90	70			
SP..D2 046 ISO	✓	✓	46	40	54	198	92	70			
SP..D2 047 ISO	✓	✓	47	40	54	201	94	70			
SP..D2 048 ISO	✓	✓	48	40	54	204	96	70			
SP..D2 049 ISO	✓	✓	49	40	54	207	98	70			
SP..D2 050 ISO	✓	✓	50	40	54	210	100	70			

Takma uçlu matkaplarda ±0,20 mm ölçü toleransı vardır / U-drill have a diameter tolerance between ±0,20 mm

L: Sol / Left

R: Sağ / Right

✓ Stokta / In Stock

✗ Stokta Yok / Non Stock

Lütfen Sipariş vermeden önce stok durumunu sorunuz.
Please ask before ordering, stock status.

DRILL SP.. D3

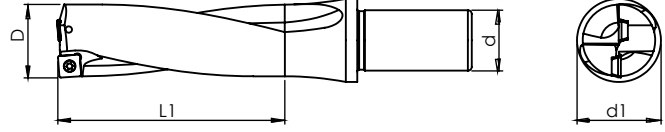

Kesici Uç Uyumluluğu Insert Suitability	Stok / Stock		Takım Ölçüleri / Dimension (mm)						Uç Insert	Vida Screw	Anahtar Torx Key
	TGTC / PLBT / ZCC / KLP	Inter Cooland	D	d	d1	L	L1	L2			
SP..D3 012,5 ISO	✓	✓	12,5	20	25	101	37,5	50	SP..050204	M2X5	T06
SP..D3 013 ISO	✓	✓	13	20	25	101	39	50			
SP..D3 013,5 ISO	✓	✓	13,5	20	25	105	40,5	50			
SP..D3 014 ISO	✓	✓	14	20	25	105	42	50			
SP..D3 014,5 ISO	✓	✓	14,5	20	25	109	43,5	50			
SP..D3 015 ISO	✓	✓	15	20	25	109	45	50			
SP..D3 015,5 ISO	✓	✓	15,5	20	25	110	46,5	50			
SP..D3 016 ISO	✓	✓	16	25	34	126	48	56			
SP..D3 016,5 ISO	✓	✓	16,5	25	34	129	49,5	56			
SP..D3 017 ISO	✓	✓	17	25	34	129	51	56			
SP..D3 017,5 ISO	✓	✓	17,5	25	34	132	52,5	56			
SP..D3 018 ISO	✓	✓	18	25	34	132	54	56			
SP..D3 018,5 ISO	✓	✓	18,5	25	34	135	55,5	56			
SP..D3 019 ISO	✓	✓	19	25	34	135	57	56			
SP..D3 019,5 ISO	✓	✓	19,5	25	34	139	58,5	56			
SP..D3 020 ISO	✓	✓	20	25	34	139	60	56			
SP..D3 020,5 ISO	✓	✓	20,5	25	34	143	61,5	56			
SP..D3 021 ISO	✓	✓	21	25	34	143	63	56			
SP..D3 021,5 ISO	✓	✓	21,5	25	34	147	64,5	56			
SP..D3 022 ISO	✓	✓	22	25	34	147	66	56			
SP..D3 022,5 ISO	✓	✓	22,5	25	34	151	67,5	56			
SP..D3 023 ISO	✓	✓	23	25	34	151	69	56			
SP..D3 023,5 ISO	✓	✓	23,5	25	34	153	70,5	56			
SP..D3 024 ISO	✓	✓	24	25	34	153	72	56			
SP..D3 024,5 ISO	✓	✓	24,5	25	34	156	73,5	56			
SP..D3 025 ISO	✓	✓	25	25	34	156	75	56			
SP..D3 025,5 ISO	✓	✓	25,5	25	34	160	76,5	56			
SP..D3 026 ISO	✓	✓	26	25	34	160	78	56			
SP..D3 026,5 ISO	✓	✓	26,5	25	34	164	79,5	56			
SP..D3 027 ISO	✓	✓	27	25	34	164	81	56			
SP..D3 027,5 ISO	✓	✓	27,5	25	34	168	82,5	56			
SP..D3 028 ISO	✓	✓	28	25	34	168	84	56			
SP..D3 028,5 ISO	✓	✓	28,5	25	34	172	85,5	56			
SP..D3 029 ISO	✓	✓	29	25	34	172	87	56			
SP..D3 029,5 ISO	✓	✓	29,5	25	44	180	88,5	56			
SP..D3 030 ISO	✓	✓	30	32	44	180	90	60			
SP..D3 031 ISO	✓	✓	31	32	44	184	93	60			
SP..D3 032 ISO	✓	✓	32	32	44	188	96	60			
SP..D3 033 ISO	✓	✓	33	32	44	192	99	60			
SP..D3 034 ISO	✓	✓	34	32	44	192	102	60			
SP..D3 035 ISO	✓	✓	35	32	44	200	105	60			
SP..D3 036 ISO	✓	✓	36	32	44	204	108	60			
SP..D3 037 ISO	✓	✓	37	32	44	208	111	60			
SP..D3 038 ISO	✓	✓	38	32	44	212	114	60			
SP..D3 038,5 ISO	✓	✓	38,5	32	44	216	115,5	60			
SP..D3 039 ISO	✓	✓	39	32	44	216	117	60			
SP..D3 040 ISO	✓	✓	40	32	44	220	120	60			
SP..D3 041 ISO	✓	✓	41	32	44	223	123	60			
SP..D3 041,5 ISO	✓	✓	41,5	32	44	226	124,5	60			
SP..D3 042 ISO	✓	✓	42	32	44	226	126	60			
SP..D3 043 ISO	✓	✓	43	32	44	229	129	60			
SP..D3 044 ISO	✓	✓	44	32	44	232	132	60			
SP..D3 045 ISO	✓	✓	45	40	54	245	135	70			
SP..D3 046 ISO	✓	✓	46	40	54	248	138	70			
SP..D3 047 ISO	✓	✓	47	40	54	251	141	70			
SP..D3 048 ISO	✓	✓	48	40	54	254	144	70			
SP..D3 049 ISO	✓	✓	49	40	54	257	147	70			
SP..D3 050 ISO	✓	✓	50	40	54	260	150	70			

Takma uçlu matkaplarda ±0,20 mm ölçü toleransı vardır / U-drill have a diameter tolerance between ±0,20 mm

Lütfen Sipariş vermeden önce stok durumunu sorunuz.
Please ask before ordering, stock status.

L: Sol / Left

R: Sağ / Right

✓ Stokta / In Stock

✗ Stokta Yok / Non Stock

DRILL SP.. D4

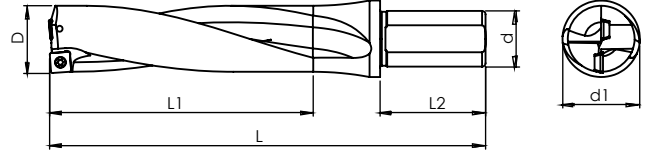

Kesici Uç Uyumluluğu Insert Suitability	Stok / Stock		Takım Ölçüleri / Dimension (mm)						Uç Insert	Vida Screw	Anahtar Torx Key
	TGTC / PLBT / ZCC / KLP	Inter Coolant	D	d	d1	L	L1	L2			
SP..D4 013 ISO	✓	✓	13	20	25	115	52	50	SP..050204	M2X5	T06
SP..D4 014 ISO	✓	✓	14	20	25	119	56	50			
SP..D4 014,5 ISO	✓	✓	14,5	20	25	124	60	50			
SP..D4 015 ISO	✓	✓	15	20	25	124	60	50			
SP..D4 015,5 ISO	✓	✓	15,5	20	25	128	62	50			
SP..D4 016 ISO	✓	✓	16	25	34	142	64	56	SP..060204	M2.2X5	
SP..D4 017 ISO	✓	✓	17	25	34	146	68	56			
SP..D4 017,5 ISO	✓	✓	17,5	25	34	150	72	56			
SP..D4 018 ISO	✓	✓	18	25	34	150	72	56			
SP..D4 019 ISO	✓	✓	19	25	34	154	76	56			
SP..D4 019,5 ISO	✓	✓	19,5	25	34	159	78	56	SP..07T308	M2.5X7	
SP..D4 020 ISO	✓	✓	20	25	34	159	80	56			
SP..D4 021 ISO	✓	✓	21	25	34	164	84	56			
SP..D4 022 ISO	✓	✓	22	25	34	169	88	56			
SP..D4 023 ISO	✓	✓	23	25	34	174	92	56			
SP..D4 023,5 ISO	✓	✓	23,5	25	34	174	92	56	SP..090408	M3,5X8	
SP..D4 024 ISO	✓	✓	24	25	34	177	96	56			
SP..D4 024,5 ISO	✓	✓	23,5	25	34	181	100	56			
SP..D4 025 ISO	✓	✓	25	25	34	181	100	56			
SP..D4 026 ISO	✓	✓	26	25	34	186	104	56			
SP..D4 027 ISO	✓	✓	27	25	34	191	108	56	SP..110408	M4X11	
SP..D4 027,5 ISO	✓	✓	27,5	25	34	191	112	56			
SP..D4 028 ISO	✓	✓	28	25	34	196	112	56			
SP..D4 029 ISO	✓	✓	29	25	34	201	116	56			
SP..D4 030 ISO	✓	✓	30	32	44	210	120	60			
SP..D4 031 ISO	✓	✓	31	32	44	215	124	60	SP..140512	M5X11	
SP..D4 032 ISO	✓	✓	32	32	44	220	128	60			
SP..D4 033 ISO	✓	✓	33	32	44	225	132	60			
SP..D4 033,5 ISO	✓	✓	33,5	32	44	225	136	60			
SP..D4 034 ISO	✓	✓	34	32	44	230	136	60			
SP..D4 035 ISO	✓	✓	35	32	44	235	140	60	T15		
SP..D4 036 ISO	✓	✓	36	32	44	238	144	60			
SP..D4 037 ISO	✓	✓	37	32	44	241	148	60			
SP..D4 038 ISO	✓	✓	38	32	44	244	152	60			
SP..D4 038,5 ISO	✓	✓	38,5	32	44	247	156	60			
SP..D4 039 ISO	✓	✓	39	32	44	247	156	60	T20		
SP..D4 039,5 ISO	✓	✓	39,5	32	44	250	158	60			
SP..D4 040 ISO	✓	✓	40	32	44	250	160	60			
SP..D4 041 ISO	✓	✓	41	32	44	253	164	60			
SP..D4 042 ISO	✓	✓	42	32	44	256	168	60			
SP..D4 043 ISO	✓	✓	43	32	44	259	172	60	T20		
SP..D4 044 ISO	✓	✓	44	32	44	262	176	60			
SP..D4 045 ISO	✓	✓	45	40	54	265	180	70			
SP..D4 046 ISO	✓	✓	46	40	54	268	184	70			
SP..D4 047 ISO	✓	✓	47	40	54	271	188	70			
SP..D4 048 ISO	✓	✓	48	40	54	274	192	70	T20		
SP..D4 049 ISO	✓	✓	49	40	54	277	196	70			
SP..D4 050 ISO	✓	✓	50	40	54	280	200	70			

Takma uçlu matkaplarda ±0,20 mm ölçü toleransı vardır / U-drill have a diameter tolerance between ±0,20 mm

L: Sol / Left

R: Sağ / Right



✓ Stokta / In Stock

✗ Stokta Yok / Non Stock

Lütfen Sipariş vermeden önce stok durumunu sorunuz.
Please ask before ordering, stock status.

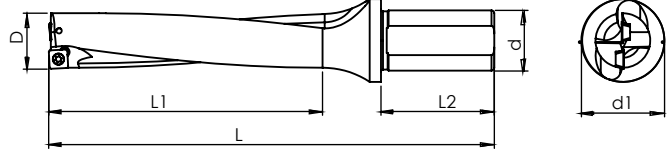
DRILL SP.. D5



Kesici Uç Uyumluluğu Insert Suitability	Stok / Stock		Takım Ölçüleri / Dimension (mm)						Uç İnsert	Vida Screw	Anahtar Torx Key
	TGTC / PLBT / ZCC / KLP	Inter Cooland	D	d	d1	L	L1	L2			
	X	✓	13	20	25	120	65	50	SP..050204	M2X5	
SP..D5 013 ISO	X	✓	14	20	25	124	70	50			
SP..D5 014 ISO	X	✓	15	20	25	128	75	50			
SP..D5 015 ISO	✓	✓	16	25	34	153	80	56	SP..060204	M2.2X6	T06
SP..D5 016 ISO	✓	✓	17	25	34	158	85	56			
SP..D5 017 ISO	✓	✓	18	25	34	163	90	56			
SP..D5 018 ISO	✓	✓	19	25	34	168	95	56	SP..07T308	M2.5X7	T08
SP..D5 019 ISO	✓	✓	20	25	34	174	100	56			
SP..D5 020 ISO	✓	✓	21	25	34	180	105	56			
SP..D5 021 ISO	✓	✓	22	25	34	186	110	56	SP..07T308	M2.5X7	T08
SP..D5 022 ISO	✓	✓	23	25	34	192	115	56			
SP..D5 023 ISO	✓	✓	24	25	34	196	120	56			
SP..D5 024 ISO	✓	✓	25	25	34	200	125	56	SP..090408	M3,5X8	T15
SP..D5 025 ISO	✓	✓	26	25	34	206	130	56			
SP..D5 026 ISO	✓	✓	27	25	34	212	135	56			
SP..D5 027 ISO	✓	✓	28	25	34	218	140	56			
SP..D5 028 ISO	✓	✓	29	25	34	224	145	56			
SP..D5 029 ISO	✓	✓	30	32	44	233	150	60			
SP..D5 030 ISO	✓	✓									

Takma uçlu matkaplarda ±0,20 mm ölçü toleransı vardır / U-drill have a diameter tolerance between ±0,20 mm

Lütfen Sipariş vermeden önce stok durumunu sorunuz.
Please ask before ordering, stock status.

L: Sol / Left

R: Sağ / Right

✓ Stokta / In Stock

X Stokta Yok / Non Stock

DRILL XOMT-SPMT D2

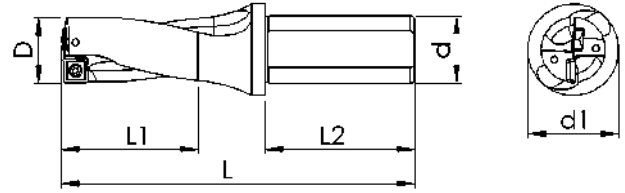

Kesici Uç Uyumluluğu Insert Suitability	Stok / Stock		Takım Ölçüleri / Dimension (mm)						Uç Insert	Vida Screw	Anahtar Torx Key
		Inter Cooland	D	d	d1	L	L1	L2			
XOMT - SPMT D2											
XOSP D2 016 ISO	✓	✓	16	25	34	110	32	50	SPMT 050204 XOMT 050204	M2.2X5	T08
XOSP D2 017 ISO	✓	✓	17	25	34	112	34	56	SPMT 060205 XOMT 060204	M2.2X6	
XOSP D2 018 ISO	✓	✓	18	25	34	114	36	56			
XOSP D2 019 ISO	✓	✓	19	25	34	116	38	56	SPMT 07T208 XOMT 07T205	M3X7	
XOSP D2 020 ISO	✓	✓	20	25	34	119	40	56			
XOSP D2 021 ISO	✓	✓	21	25	34	122	42	56			
XOSP D2 022 ISO	✓	✓	22	25	34	125	44	56			
XOSP D2 023 ISO	✓	✓	23	25	34	128	46	56	SPMT 90308 XOMT 90305	M3X7	
XOSP D2 024 ISO	✓	✓	24	25	34	129	48	56			
XOSP D2 025 ISO	✓	✓	25	25	34	131	50	56			
XOSP D2 026 ISO	✓	✓	26	25	34	134	52	56			
XOSP D2 027 ISO	✓	✓	27	25	34	137	54	56			
XOSP D2 028 ISO	✓	✓	28	25	34	140	56	56			
XOSP D2 029 ISO	✓	✓	29	25	34	143	58	56	SPMT 11T308 XOMT 11T306	M3.5X9	T15
XOSP D2 030 ISO	✓	✓	30	32	44	150	60	60			
XOSP D2 031 ISO	✓	✓	31	32	44	153	62	60			
XOSP D2 032 ISO	✓	✓	32	32	44	156	64	60			
XOSP D2 033 ISO	✓	✓	33	32	44	159	66	60			
XOSP D2 034 ISO	✓	✓	34	32	44	162	68	60			
XOSP D2 035 ISO	✓	✓	35	32	44	165	70	60			

DRILL XOMT-SPMT D3

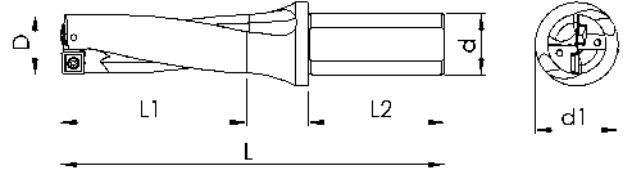

Kesici Uç Uyumluluğu Insert Suitability	Stok / Stock		Takım Ölçüleri / Dimension (mm)						Uç Insert	Vida Screw	Anahtar Torx Key
		Inter Cooland	D	d	d1	L	L1	L2			
XOMT - SPMT D3											
XOSP D3 016 ISO	✓	✓	16	25	34	126	48	56	SPMT 050204 XOMT 050204	M2.2X5	T08
XOSP D3 017 ISO	✓	✓	17	25	34	129	51	56	SPMT 060205 XOMT 060204	M2.2X6	
XOSP D3 018 ISO	✓	✓	18	25	34	132	54	56			
XOSP D3 019 ISO	✓	✓	19	25	34	135	57	56	SPMT 07T208 XOMT 07T205	M2.2X6	
XOSP D3 020 ISO	✓	✓	20	25	34	139	60	56			
XOSP D3 021 ISO	✓	✓	21	25	34	143	63	56			
XOSP D3 022 ISO	✓	✓	22	25	34	147	66	56	SPMT 90308 XOMT 90305	M3X7	T10
XOSP D3 023 ISO	✓	✓	23	25	34	151	69	56			
XOSP D3 024 ISO	✓	✓	24	25	34	153	72	56			
XOSP D3 025 ISO	✓	✓	25	25	34	156	75	56			
XOSP D3 026 ISO	✓	✓	26	25	34	160	78	56			
XOSP D3 027 ISO	✓	✓	27	25	34	164	81	56			
XOSP D3 028 ISO	✓	✓	28	25	34	168	84	56	SPMT 11T308 XOMT 11T306	M3.5X9	T15
XOSP D3 029 ISO	✓	✓	29	25	34	172	87	56			
XOSP D3 030 ISO	✓	✓	30	32	44	180	90	60			
XOSP D3 031 ISO	✓	✓	31	32	44	184	93	60			
XOSP D3 032 ISO	✓	✓	32	32	44	188	96	60			
XOSP D3 033 ISO	✓	✓	33	32	44	192	99	60			
XOSP D3 034 ISO	✓	✓	34	32	44	192	102	60			
XOSP D3 035 ISO	✓	✓	35	32	44	200	105	60			

Takma uçlu matkaplarda $\pm 0,20$ mm ölçü toleransı vardır / U-drill have a diameter tolerance between $\pm 0,20$ mm

Lütfen Sipariş vermeden önce stok durumunu sorunuz.
Please ask before ordering, stock status.

L: Sol / Left



R: Sağ / Right

✓ Stokta / In Stock

✗ Stokta Yok / Non Stock

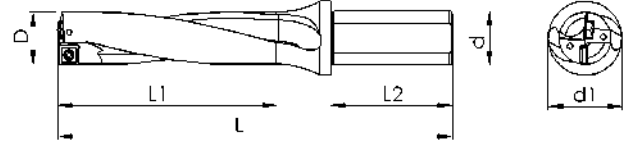
DRILL XOMT-SPMT D4



Kesici Uç Uyumluluğu Insert Suitability	Stok / Stock		Takım Ölçüleri / Dimension (mm)						Uç Insert	Vida Screw	Anahtar Torx Key
		Inter Cooland	D	d	d1	L	L1	L2			
XOSP D4 016 ISO	✓	✓	16	25	34	142	64	50	SPMT 050204 XOMT 050204	M2.2X5	T08
XOSP D4 017 ISO	✓	✓	17	25	34	146	68	56			
XOSP D4 018 ISO	✓	✓	18	25	34	150	72	56	SPMT 060205 XOMT 060204	M2.2X6	
XOSP D4 019 ISO	✓	✓	19	25	34	154	76	56			
XOSP D4 020 ISO	✓	✓	20	25	34	159	80	56	SPMT 07T208 XOMT 07T205	M2.2X6	
XOSP D4 021 ISO	✓	✓	21	25	34	164	84	56			
XOSP D4 022 ISO	✓	✓	22	25	34	169	88	56			
XOSP D4 023 ISO	✓	✓	23	25	34	174	92	56			
XOSP D4 024 ISO	✓	✓	24	25	34	177	96	56	SPMT 90308 XOMT 90305	M3X7	T10
XOSP D4 025 ISO	✓	✓	25	25	34	181	100	56			
XOSP D4 026 ISO	✓	✓	26	25	34	186	104	56			
XOSP D4 027 ISO	✓	✓	27	25	34	191	108	56			
XOSP D4 028 ISO	✓	✓	28	25	34	196	112	56	SPMT 11T308 XOMT 11T306	M3.5X9	T15
XOSP D4 029 ISO	✓	✓	29	25	34	201	116	56			
XOSP D4 030 ISO	✓	✓	30	32	44	210	120	60			
XOSP D4 031 ISO	✓	✓	31	32	44	215	124	60			
XOSP D4 032 ISO	✓	✓	32	32	44	220	128	60			
XOSP D4 033 ISO	✓	✓	33	32	44	225	132	60			
XOSP D4 034 ISO	✓	✓	34	32	44	230	136	60			
XOSP D4 035 ISO	✓	✓	35	32	44	235	140	60			

PASO KATERLERİ - STEP CUTTING TOOLS

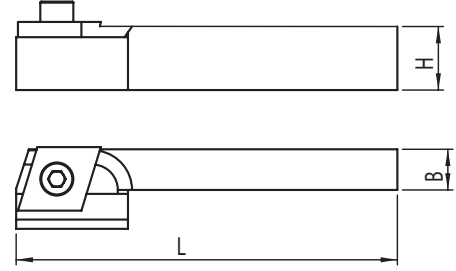

TORNA KATERİ	Stok / Stock	Takım Ölçüleri / Dimension (mm)				Vida Screw	Anahtar Allen Key
		H	B	L1	L2		
HSS PS 001 ISO	✓	25	17	45	150	M8X25	A6
HSS PS 002 ISO	✓	25	17	45	150		
HSS PS 003 ISO	✓	25	17	45	150		
HSS PS 004 ISO	✓	25	17	45	150		

KESME KATERLERİ - CUTTING TOOLS

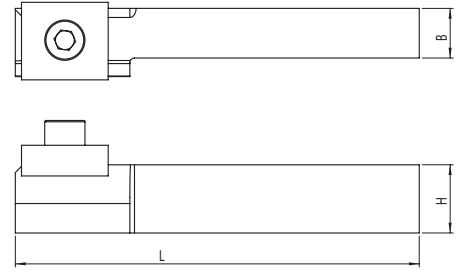

TORNA KATERİ	Stok / Stock	Takım Ölçüleri / Dimension (mm)				Vida Screw	Anahtar Allen Key
		H	B	L1	L2		
HSS KS 001 ISO	✓	25	17	45	150	M8X25	A6
HSS KS 002 ISO	✓	22	16	37	150		
HSS KS 003 ISO	✓	25	17	45	150		
HSS KS 004 ISO	✓	25	17	46	150		
HSS KS 005 ISO	✓	25	17	45	150		

PUNTA KATERLERİ - PUNTA TOOL

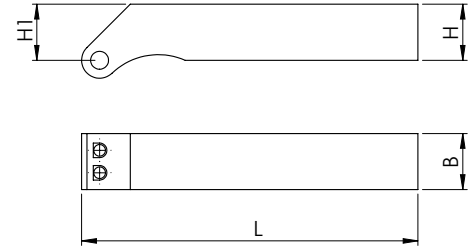

TORNA KATERİ	Stok / Stock	Takım Ölçüleri / Dimension (mm)				Vida Screw	Anahtar Allen Key
		H1	H	B	L1		
CNC PUNTA 001	✓	20	20	20	125	M5X8	A4
CNC PUNTA 002	✓	20	20	20	125		
CNC PUNTA 004	✓	25	25	25	150	M6X10	A5
CNC PUNTA 005	✓	25	25	25	150		

TIRTIR TEKLİ - SINGLE TOOLS

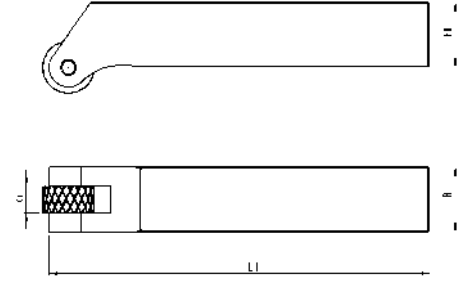

TIRTIR KATER	Stok / Stock	Takım Ölçüleri / Dimension (mm)				Pim Pin	
		B	H	a	L		
TIR TIR 001	✓	10	10	4	125	4X10	
TIR TIR 003	✓	12	12	6	125	4X12	
TIR TIR 004	✓	12	12	6	125	6X12	
TIR TIR 005	✓	16	16	6	125	4x16	
TIR TIR 006	✓	16	16	8	125	6x16	
TIR TIR 007	✓	20	20	8	125	6x20	
TIR TIR 008	✓	20	20	10	125	6x20	
TIR TIR 009	✓	25	25	8	150	6x25	
TIR TIR 010	✓	25	25	10	150	6x25	
TIR TIR 015	✓	16	16	6	125	4x16	
TIR TIR 016	✓	16	16	6	125	6x16	
TIR TIR 017	✓	16	16	8	125	6x16	
TIR TIR 018	✓	16	16	10	125	6x16	
TIR TIR 019	✓	25	25	10	150	6X25	R45
TIR TIR 020	✓	20	20	10	125	6X20	R45
TIR TIR 021	✓	16	16	8	125	6X16	R45
TIR TIR 022	✓	16	16	10	125	6X16	R45

TIRTIR ÇİFTLİ - DOUBLE TOOLS

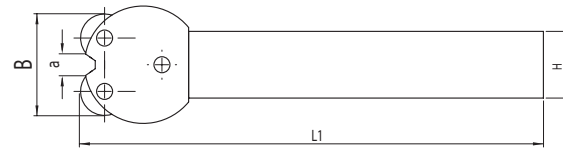

ÇİFTLİ TIRTIR	Stok / Stock	Takım Ölçüleri / Dimension (mm)				Pim Pin	
		B	H	a	L		
TIR TIR Ç 001	✓	22	22	10	150	6x25	

T SOMUN

NEW

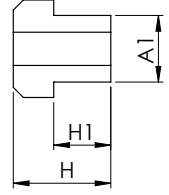
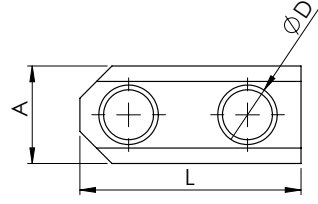

T SOMUN	Stok / Stock	Takım Ölçüleri / Dimension (mm)						
		Ayna Çapı Chuck Dia	L	A	A1	H	H1	d
TS6 001 6" T-SOMUN	✓	6"	36	17	12	18,5	11	M10
TS6 002 8" T-SOMUN	✓	8"	46,5	20,5	14	20,5	12	M12
TS6 003 10" T-SOMUN	✓	10"	51	22,5	16	21,5	13	M12

STANDART YUMUŞAK AYAK
STANDARD SOFT JAWS

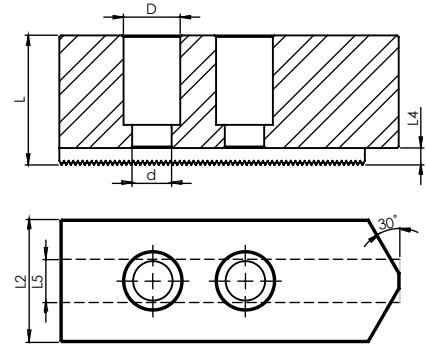

SYA	Stok / Stock	Takım Ölçüleri / Dimension (mm)							
		D	d	L	L1	L2	L4	L5	L5
SYA 001	✓	18,5	12,8	37	95	35	5,5	14,15	12
SYA 002	✓	18,5	12,8	42	110	39,75	5,5	16,15	14
SYA 003	✓	17	10,5	32	72	30	5,5	12	10

SİVRİ STANDART YUMUŞAK AYAK
POINTED STANDARD SOFT JAWS

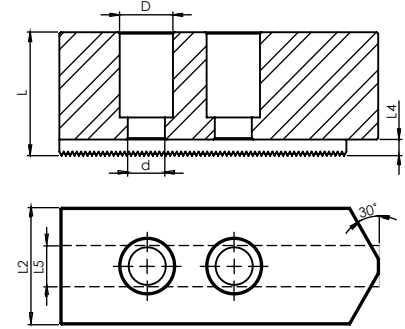

SSYA	Stok / Stock	Takım Ölçüleri / Dimension (mm)							
		D	d	L	L1	L2	L4	L5	L5
SSYA 001	✓	18,5	12,8	37	95	35	5,5	14,15	1,5
SSYA 002	✓	18,5	12,8	42	110	40	5,5	16,15	1,5

YÜKSEK YUMUŞAK AYAK
HIGH SOFT JAWS

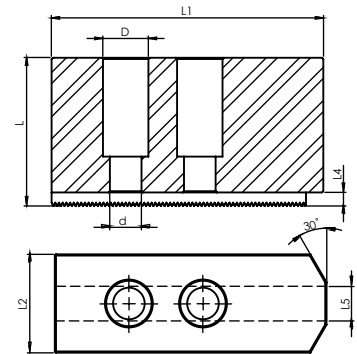

YYA	Stok / Stock	Takım Ölçüleri / Dimension (mm)							
		D	d	L	L1	L2	L4	L5	L5
YYA 001	✓	18,5	12,8	37	95	35	5,5	14,15	12
YYA 002	✓	18,5	12,8	42	110	39,75	5,5	16,15	14
YYA 003	✓	17	10,5	32	72	30	5,5	12	10

ÇİVATALAR - SCREWS

BASKI ÇİVATALARI

	M5X23 A3	
	M6X27 A3	

ALTLIK VİDALARI

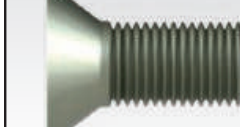
	M3X10	
	M4X10	
	M5X10	

BUKSE VİDA

	M5X0.5X3.5	
	M6X0.5X4	

TORX VİDALARI

	M1.8X3.5	
	M2X4	
	M2X5	
	M2X6	
	M2.2X5	
	M2.2X6	
	M2.5X5	
	M2.5X6	
	M2.5X7	
	M2.5X8	
	M2.5X10	
	M3X6	
	M3X7	
	M3X8 LOGU M4X16 WLTR	

BASKI VİDASI

	M6X0.75 TPKN 16	
---	-----------------	--

TORX VİDALARI

	M3X8	
	M3X10	
	M3.5X8	
	M3.5X9	
	M3.5X10	
	M3.5X11	
	M3.5X14	
	M4X11	
	M4X12	
	M4.5X16	
	M5X12	

BASKI VİDASI

	M8X1 TPKN 22	
---	--------------	--

KESME KATER VİDASI

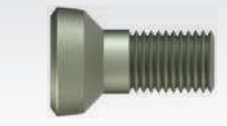
	M8X27 A4	
---	----------	--

P SİSTEM VİDASI

	MPV M8 U	
	MPV M8 K	

KÜRE TAKIM VİDALARI - BALL NOSE SCREWS

KÜRE TAKIM VİDALARI

	M3X7 D8	
	M4X9 D10	
	M5X10 D12	
	M5X12 D16	
	M5X16 D20	
	M6X22 D25	
	M8X25 D30	

ALTLIKLAR - SHIMS

ALTLIK		
	DNMG 15 - T SİSTEM	
	DNMG 11 - T SİSTEM	
	DNMG 11 - P SİSTEM	
	DNMG 15 - P SİSTEM	

ALTLIK		
	CNMG 12 - T SİSTEM	
	CNMG 16 - T SİSTEM	
	CNMG 19 - T SİSTEM	
	CNMG 12 - P SİSTEM	
	CNMG 16 - P SİSTEM	
	CNMG 19 - P SİSTEM	

ALTLIK		
	TNMG 16 - T/M SİSTEM	
	TNMG 22 - T/M SİSTEM	
	TNMG 16 - P SİSTEM	
	TNMG 22 - P SİSTEM	

ALTLIK		
	WNMG 08 - T/M SİSTEM	
	WNMG 06 - P SİSTEM	
	WNMG 08 - P SİSTEM	

ALTLIK		
	DCMT 11	

ALTLIK		
	VBMT 16 - S SİSTEM	
	VCMT 16 - S SİSTEM	

ALTLIK		
	KNUX 16 SAĞ C SİSTEM	

ALTLIK		
	KNUX 16 SOL C SİSTEM	

ALTLIK		
	SIR/SER 16 - S SİSTEM	
	SIR/SER 22 - S SİSTEM	

ALTLIK		
	SNMG 12 - T SİSTEM	
	SNMG 15 - T SİSTEM	
	SNMG 19 - T SİSTEM	
	SNMG 12 - P SİSTEM	
	SNMG 15 - P SİSTEM	
	SNMG 19 - P SİSTEM	

ALTLIK		
	CCMT 12 - S SİSTEM	

ALTLIK		
	TCMT 16 - S SİSTEM	

P SİSTEM LEVYE			
	MPL 011	DNMG 11 -	
	MPL 012	CNMG 12 -	
	MPL 016	CNMG 16 -	
	MPL 019	CNMG 19 -	

P SİSTEM ALTLIK SACI			
	MPS 011	DNMG 11 -	
	MPS 012	CNMG 12 -	
	MPS 016	CNMG 16 -	
	MPS 019	CNMG 19 -	

BASKI KEPLERİ - CLAMPS

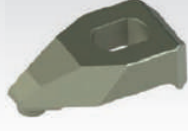
BASKI PABUCU		
	T190105 CNMG 19	
	T190105 SNMG 19	

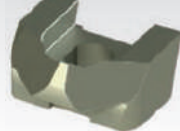
BASKI PABUCU		
	M220105 TNMG 22	

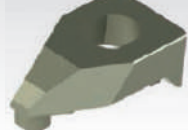
BASKI PABUCU		
	T110105 DNMG 11	
	T160105 TNMG 16	
	T060105 WNMG 06	

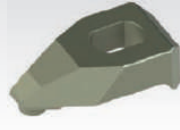
BASKI PABUCU		
	T120105 SNMG 12	
	T120105 CNMG 12	
	T150105 DNMG 15	
	T150105 SNMG 15	
	T220105 TNMG 22	
	T060105 WNMG 08	

BASKI PABUCU		
	T160105 CNMG 16	
	T160105 VNMG 16	
	T160105 SNMG 15	

BASKI PABUCU		
	M160105 TNMG 16	

BASKI PABUCU		
	M060105 WNMG 06	

BASKI PABUCU		
	C160105 KNUX 16 SAĞ	
	C160105 KNUX 16 SOL	
	C160105 KNUX 16 SOL VE SAĞ	

BASKI PABUCU		
	CK 14	
	CK 15	

BASKI PABUCU		
	C160105 TPKN 16	

M SİSTEM ALTLIK PİMİ		
	5X3.6X15 TNMG 16	
	5X3.6X15 WNMG 06	

BASKI PABUCU		
	M080105 WNMG 08	

BASKI PABUÇ YAYI		
	BASKI PABUÇU YAYI	

BASKI PABUÇ VİDASI PULU		
	10X6X1 MM	

M SİSTEM ALTLIK PİMİ		
	6X5X18 TNMG 22	
	6X5X18 WNMG 08	

TORNALAMA İÇİN FORMÜLLER

<p>DEVİR SAYISI = $n = \frac{V_c \times 1000}{\pi \times D}$ devir / dakika Revolutions / Umdrehungen</p>	<p>n: Devir Sayısı (dev./dak) Revolutions / Umdrehungen</p>
<p>KESME HIZI = $V_c = \frac{\pi \times D \times n}{1000}$ metre / dakika Cutting speed / Schnittgeschwindigkeit</p>	<p>Vc: Kesme Hızı (m./dak.) Cutting Speed / Schnittgeschwindigkeit (Meter/ Min)</p>
<p>DEVİR SAYISI = $n = \frac{V_c \times 1000}{\pi \times D}$ devir / dakika Revolutions / Umdrehungen</p>	<p>D: İş Parçasının Çapı (mm) Workpiece diameter / Werkstückdurchmesser</p>
<p>KESME HIZI = $V_c = \frac{\pi \times D \times n}{1000}$ metre / dakika Cutting speed / Schnittgeschwindigkeit</p>	<p>π: Sabit Sayı(3,14) Constant (3,14) / Gleich bleibend (3,14)</p>

TORNALAMA İŞLEMİNDE ZAMANININ HESAPLANMASI

<p>Çap Tornalamada = $t_h = \frac{L \times P_s}{n \times f}$ dakika Turning diameter / Drehdurchmesser</p>	<p>Ps: Paso Sayısı (kaç defada) no of passes / Durchgänge</p>
<p>Alın Tornalama = $t_h = \frac{d \times \pi \times L \times P_s}{V_c \times 1000 \times f}$ dakika Length turning / Stirn Drehen</p>	<p>th: İşleme Zamanı (dakika) Processing Time / Bearbeitungszeit (min)</p>
<p>Alın Tornalama = $t_h = \frac{d \times \pi \times L \times P_s}{V_c \times 1000 \times f}$ dakika Length turning / Stirn Drehen</p>	<p>f: İlerleme (mm) Length delivery / Stirn Zustellung (min.)</p>
<p>Alın Tornalama = $t_h = \frac{d \times \pi \times L \times P_s}{V_c \times 1000 \times f}$ dakika Length turning / Stirn Drehen</p>	<p>Alın Tornalama İçin Boy Length for face turning / Länge für Stirn Drehen</p>
<p>Alın Tornalama = $t_h = \frac{d \times \pi \times L \times P_s}{V_c \times 1000 \times f}$ dakika Length turning / Stirn Drehen</p>	<p>Dolu Malzemede Alın Tornalama Face turning for solid tool / Massive Werkstücke Stirn Drehen</p>

YÜZEY FREZELEMEDE KULLANILAN FORMÜLLER

<p>DEVİR SAYISI = $n = \frac{V_c \times 1000}{\pi \times D}$ devir / dakika Revolutions / Umdrehungen</p>	<p>z: Frezenin Ağız Sayısı (adet) Number of tooth / Anzahl Schneiden</p>
<p>KESME HIZI = $V_c = \frac{\pi \times D \times n}{1000}$ metre / dakika Revolutions / Umdrehungen</p>	<p>k: Disk Frezenin Efektif Ağız sayısı (adet) Effective edge of the cutter / Effektive Schneiden des Fräasers</p>
<p>TABLA İLERLEMESİ = $V_f = n \times z \times f_z$ mm/ dak Delivery / Zustellung</p>	<p>fz : Ağız başına ilerleme (mm/ağız) Delivery per cutting mm /Z/ Zustellung pro Schneide mm/Z</p>
<p>TABLA İLERLEMESİ = $V_f = n \times z \times f_z$ mm/ dak Delivery / Zustellung</p>	<p>th: İşleme Zamanı (dak.) Processing time / Bearbeitungszeit minute</p>
<p>TABLA İLERLEMESİ = $V_f = n \times z \times f_z$ mm/ dak Delivery / Zustellung</p>	<p>Ps : Paso Sayısı Number of passes / Anzahl der Durchgänge</p>

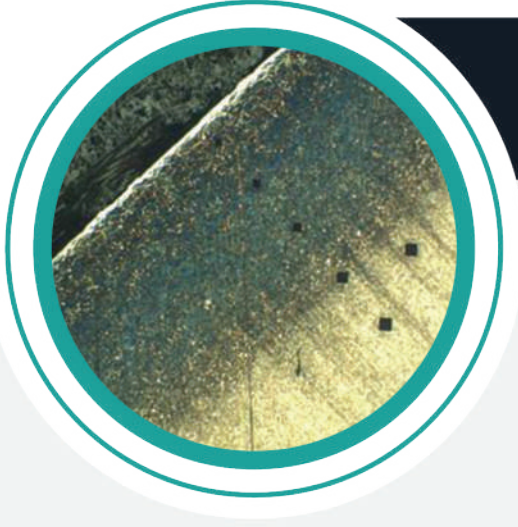

PLASMA NITRATION

Nedir?

Vasıflı çelik malzemelerde uygulanabilen bir yüzey sertleştirme yöntemidir. İşlem için özel tasarlanmış vakum fırınlarında, elektrik akımı vasıtasıyla proses gazlarının iyonize edilerek iş parçalarına yönlendirilmesi sayesinde gerçekleşir.

What Is It?

It is surface hardening method which can be applied inskilled steel materials. The procedure takes place inspecial designed vacuum furnaces by means of electric current in ionizing the process gases and directing them to workpieces.

Avantajlar

- Aşınma direncini artırır.
- Yorulma ömrünü uzatır.
- Çarpılma riski minimum düzeydedir.
- Yüksek yüzey sertliği sağlar.
- Ölçü hassasiyeti yüksektir.
- Korozyon direncini artırır.
- Temiz ve parlak yüzeyler elde edilir.
- Sertlik dağılımı homojendir.
- Çevreyi kirletmez.
- Çalışan sağlığına zarar vermez.

Advantages

- Increases wear resistance.
- Extends fatigue life.
- The risk of distortion is minimal.
- Provides high surface hardness.
- Measurement accuracy is high.
- Increases corrosion resistance.
- Clean and shiny surfaces are obtained.
- Hardness distribution is homogeneous.
- Does not pollute the environment.
- Does not harm employee health.

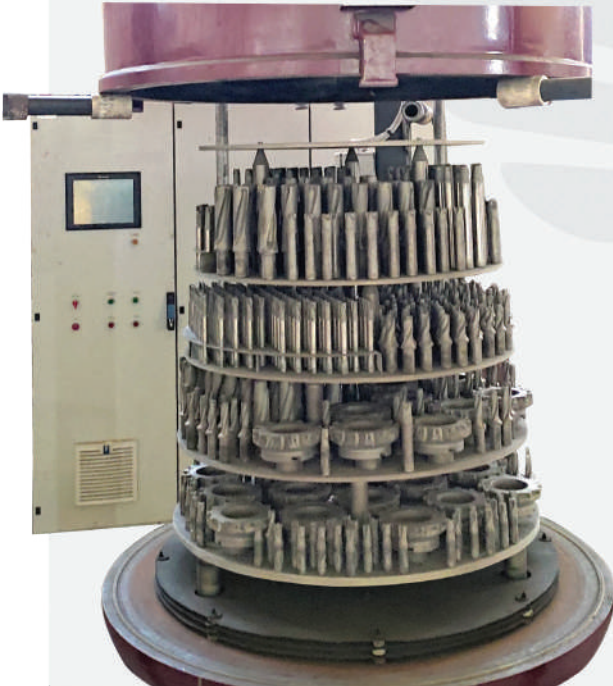
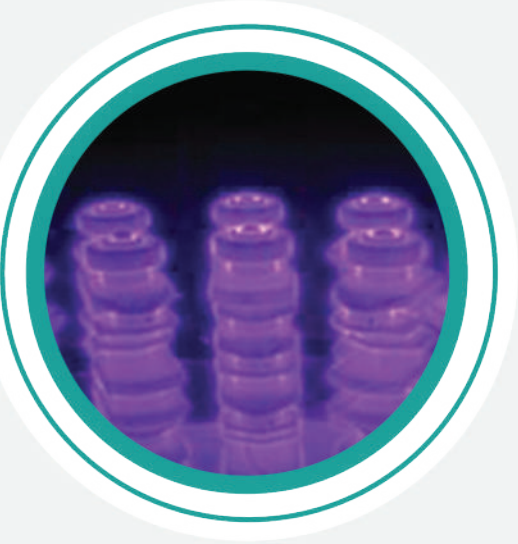



Organize Sanayi Bölgesi 40. Sok. No:19 BURDUR



T. +90 248 252 81 15 - 252 81 65 F. +90 248 252 99 37



info@baydarlar.com - info@mbckesicitakim.com



www.baydarlar.com